



AiP74LVC2G14

Dual Inverter Schmitt Trigger

Product Specification

Specification Revision History:

Version	Date	Description
2019-05-A1	2019-05	New
2021-05-A2	2021-05	Modify Transfer Characteristics Parameter
2021-09-A3	2021-09	Modify ambient temperature to $-40^{\circ}\text{C}\sim+125^{\circ}\text{C}$ and add electrical characteristics of $-40^{\circ}\text{C}\sim+125^{\circ}\text{C}$; Modify ordering information
2021-12-A4	2021-12	Modify ordering information; Modify ambient temperature to $-40^{\circ}\text{C}\sim+105^{\circ}\text{C}$ and add electrical characteristics of $-40^{\circ}\text{C}\sim+105^{\circ}\text{C}$
2022-03-A5	2022-03	Modify ordering information note 1



1、 General Description

The AiP74LVC2G14 provides two inverting buffers with Schmitt-trigger input. It is capable of transforming slowly changing input signals into sharply defined, jitter-free output signals.

The inputs can be driven from either 3.3V or 5V devices. This feature allows the use of this device in a mixed 3.3V and 5V environment. Schmitt-trigger action at the inputs makes the circuit tolerant of slower input rise and fall time. This device is fully specified for partial power-down applications using I_{OFF} . The I_{OFF} circuitry disables the output, preventing the damaging backflow current through the device when it is powered down.

Features:

- Wide supply voltage range from 1.65V to 5.5V
- 5V tolerant inputs for interfacing with 5V logic
- $\pm 24\text{mA}$ output drive ($V_{CC}=3.0\text{V}$)
- CMOS low power consumption
- Latch-up performance exceeds 250mA
- Direct interface with TTL levels
- Unlimited rise and fall times
- Input accepts voltages up to 5V
- Specified from -40°C to $+105^{\circ}\text{C}$
- Packaging information: SOT-23-6/SOT-363

Ordering Information:

Reel packing specifications:

Part number	Packaging form	Marking code	Reel quantity	Boxed reel quantity	Notes
AiP74LVC2G14GB236.TR	SOT-23-6	APXX	3000 PCS/reel	30000 PCS/box	Dimensions of plastic enclosure: 2.9mm×1.6mm Pin spacing: 0.95mm
AiP74LVC2G14GC363.TR	SOT-363	APXX	3000 PCS/reel	30000 PCS/box	Dimensions of plastic enclosure: 2.1mm×1.3mm Pin spacing: 0.65mm

Note 1: "XX" refers to variable content, meaning year and package batch serial number.

Note 2: If the physical information is inconsistent with the ordering information, please refer to the actual product.



2、Block Diagram And Pin Description

2.1、Block Diagram

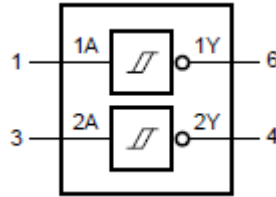

Figure 1. Logic symbol

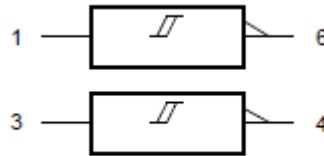

Figure 2. IEC logic symbol

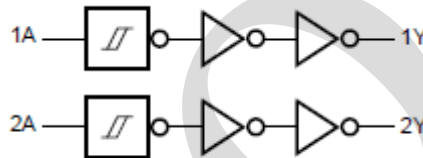
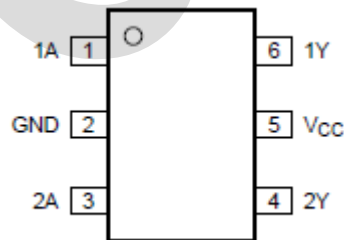

Figure 3. Logic diagram

2.2、Pin Configurations



2.3、Pin Description

Pin No.	Pin Name	Description
1	1A	data input
2	GND	ground (0V)
3	2A	data input
4	2Y	data output
5	V _{CC}	supply voltage
6	1Y	data output



2.4、Function Table

Input	Output
nA	nY
L	H
H	L

Note: H=HIGH voltage level; L=LOW voltage level.

3、Electrical Parameter

3.1、Absolute Maximum Ratings

(Voltages are referenced to GND(ground=0V), unless otherwise specified.)

Parameter	Symbol	Conditions	Min.	Max.	Unit
supply voltage	V_{CC}	-	-0.5	+6.5	V
input voltage	V_I	-	-0.5	+6.5	V
output voltage	V_O	Active mode	-0.5	$V_{CC}+0.5$	V
		Power-down mode; $V_{CC}=0V$	-0.5	+6.5	V
input clamping current	I_{IK}	$V_I < 0V$	-50	-	mA
output clamping current	I_{OK}	$V_O > V_{CC}$ or $V_O < 0V$	-	± 50	mA
output current	I_O	$V_O=0V$ to V_{CC}	-	± 50	mA
supply current	I_{CC}	-	-	100	mA
ground current	I_{GND}	-	-100	-	mA
storage temperature	T_{stg}	-	-65	+150	$^{\circ}C$
total power dissipation	P_{tot}	-	-	250	mW
Soldering temperature	T_L	10s	250		$^{\circ}C$

3.2、Recommended Operating Conditions

Parameter	Symbol	Conditions	Min.	Typ.	Max.	Unit
supply voltage	V_{CC}	-	1.65	-	5.5	V
input voltage	V_I	-	0	-	5.5	V
output voltage	V_O	Active mode	0	-	V_{CC}	V
		Power-down mode; $V_{CC}=0V$	0	-	5.5	V
ambient temperature	T_{amb}	-	-40	-	+105	$^{\circ}C$



3.3、Electrical Characteristics

3.3.1、DC Characteristics 1

($T_{amb} = -40^{\circ}\text{C}$ to $+85^{\circ}\text{C}$, voltages are referenced to GND (ground=0V), unless otherwise specified.)

Parameter	Symbol	Conditions	Min.	Typ.	Max.	Unit	
HIGH-level output voltage	V_{OH}	$V_I = V_{T+}$ or V_{T-}	$I_O = -100\mu\text{A}; V_{CC} = 1.65\text{V to } 5.5\text{V}$	$V_{CC} - 0.1$	-	-	V
			$I_O = -4\text{mA}; V_{CC} = 1.65\text{V}$	1.2	-	-	V
			$I_O = -8\text{mA}; V_{CC} = 2.3\text{V}$	1.9	-	-	V
			$I_O = -12\text{mA}; V_{CC} = 2.7\text{V}$	2.2	-	-	V
			$I_O = -24\text{mA}; V_{CC} = 3.0\text{V}$	2.3	-	-	V
			$I_O = -32\text{mA}; V_{CC} = 4.5\text{V}$	3.8	-	-	V
LOW-level output voltage	V_{OL}	$V_I = V_{T+}$ or V_{T-}	$I_O = 100\mu\text{A}; V_{CC} = 1.65\text{V to } 5.5\text{V}$	-	-	0.10	V
			$I_O = 4\text{mA}; V_{CC} = 1.65\text{V}$	-	-	0.45	V
			$I_O = 8\text{mA}; V_{CC} = 2.3\text{V}$	-	-	0.30	V
			$I_O = 12\text{mA}; V_{CC} = 2.7\text{V}$	-	-	0.40	V
			$I_O = 24\text{mA}; V_{CC} = 3.0\text{V}$	-	-	0.55	V
			$I_O = 32\text{mA}; V_{CC} = 4.5\text{V}$	-	-	0.55	V
input leakage current	I_I	$V_I = 5.5\text{V or GND}; V_{CC} = 0\text{V to } 5.5\text{V}$	-	± 0.1	± 1	μA	
power-off leakage current	I_{OFF}	V_I or $V_O = 5.5\text{V}; V_{CC} = 0\text{V}$	-	± 0.1	± 2	μA	
supply current	I_{CC}	$V_I = 5.5\text{V or GND}; I_O = 0\text{A}; V_{CC} = 1.65\text{V to } 5.5\text{V}$	-	0.1	4	μA	
additional supply current	ΔI_{CC}	$V_I = V_{CC} - 0.6\text{V}; I_O = 0\text{A}; V_{CC} = 2.3\text{V to } 5.5\text{V}$	-	5	500	μA	
input capacitance	C_I	$V_{CC} = 3.3\text{V}; V_I = \text{GND to } V_{CC}$	-	3.5	-	pF	

Note: All typical values are measured at maximum V_{CC} and $T_{amb} = 25^{\circ}\text{C}$.



3.3.2、DC Characteristics 2

($T_{amb}=-40^{\circ}\text{C}$ to $+105^{\circ}\text{C}$, voltages are referenced to GND (ground=0V), unless otherwise specified.)

Parameter	Symbol	Conditions	Min.	Typ.	Max.	Unit	
HIGH-level output voltage	V_{OH}	$V_I = V_{T+}$ or V_{T-}	$I_O=-100\mu\text{A}; V_{CC}=1.65\text{V to }5.5\text{V}$	$V_{CC} - 0.1$	-	-	V
			$I_O=-4\text{mA}; V_{CC}=1.65\text{V}$	0.95	-	-	V
			$I_O=-8\text{mA}; V_{CC}=2.3\text{V}$	1.7	-	-	V
			$I_O=-12\text{mA}; V_{CC}=2.7\text{V}$	1.9	-	-	V
			$I_O=-24\text{mA}; V_{CC}=3.0\text{V}$	2.0	-	-	V
			$I_O=-32\text{mA}; V_{CC}=4.5\text{V}$	3.4	-	-	V
LOW-level output voltage	V_{OL}	$V_I = V_{T+}$ or V_{T-}	$I_O=100\mu\text{A}; V_{CC}=1.65\text{V to }5.5\text{V}$	-	-	0.10	V
			$I_O=4\text{mA}; V_{CC}=1.65\text{V}$	-	-	0.70	V
			$I_O=8\text{mA}; V_{CC}=2.3\text{V}$	-	-	0.45	V
			$I_O=12\text{mA}; V_{CC}=2.7\text{V}$	-	-	0.60	V
			$I_O=24\text{mA}; V_{CC}=3.0\text{V}$	-	-	0.80	V
			$I_O=32\text{mA}; V_{CC}=4.5\text{V}$	-	-	0.80	V
input leakage current	I_I	$V_I=5.5\text{V or GND}; V_{CC}=0\text{V to }5.5\text{V}$	-	-	± 1	μA	
power-off leakage current	I_{OFF}	V_I or $V_O=5.5\text{V}; V_{CC}=0\text{V}$	-	-	± 2	μA	
supply current	I_{CC}	$V_I=5.5\text{V or GND}; I_O=0\text{A}; V_{CC}=1.65\text{V to }5.5\text{V}$	-	-	4	μA	
additional supply current	ΔI_{CC}	$V_I=V_{CC}-0.6\text{V}; I_O=0\text{A}; V_{CC}=2.3\text{V to }5.5\text{V}$	-	-	500	μA	

3.3.3、AC Characteristics 1

($T_{amb}=-40^{\circ}\text{C}$ to $+85^{\circ}\text{C}$, voltages are referenced to GND (ground=0V), unless otherwise specified.)

Parameter	Symbol	Conditions	Min.	Typ.	Max.	Unit	
nA to nY propagation delay	t_{pd}	see Figure 5	$V_{CC}=1.65\text{V to }1.95\text{V}$	1.0	5.6	11.0	ns
			$V_{CC}=2.3\text{V to }2.7\text{V}$	0.5	3.7	6.5	ns
			$V_{CC}=2.7\text{V}$	0.5	4.1	7.0	ns
			$V_{CC}=3.0\text{V to }3.6\text{V}$	0.5	3.9	6.0	ns
			$V_{CC}=4.5\text{V to }5.5\text{V}$	0.5	2.7	4.3	ns
Power dissipation capacitance	C_{PD}	$V_{CC}=3.3\text{V}; V_I=\text{GND to }V_{CC}$	-	18.1	-	pF	

Note:

[1] Typical values are measured at $T_{amb}=25^{\circ}\text{C}$ and $V_{CC}=1.8\text{V}, 2.5\text{V}, 2.7\text{V}, 3.3\text{V}$ and 5.0V respectively.

[2] t_{pd} is the same as t_{PLH} and t_{PHL} .

[3] C_{PD} is used to determine the dynamic power dissipation (P_D in μW).

$$P_D = C_{PD} \times V_{CC}^2 \times f_i \times N + \sum (C_L \times V_{CC}^2 \times f_o) \text{ where:}$$

f_i =input frequency in MHz;

f_o =output frequency in MHz;

C_L =output load capacitance in pF;

V_{CC} =supply voltage in V;



N=number of inputs switching;

$\sum(C_L \times V_{CC}^2 \times f_o)$ =sum of outputs.

3.3.4、 AC Characteristics 2

($T_{amb}=-40^{\circ}C$ to $+105^{\circ}C$, voltages are referenced to GND (ground=0V), unless otherwise specified.)

Parameter	Symbol	Conditions	Min.	Typ.	Max.	Unit	
nA to nY propagation delay	t_{pd}	see Figure 5	$V_{CC}=1.65V$ to $1.95V$	1.0	-	12.0	ns
			$V_{CC}=2.3V$ to $2.7V$	0.5	-	7.2	ns
			$V_{CC}=2.7V$	0.5	-	7.7	ns
			$V_{CC}=3.0V$ to $3.6V$	0.5	-	6.7	ns
			$V_{CC}=4.5V$ to $5.5V$	0.5	-	4.7	ns

Note:

[1] Typical values are measured at $T_{amb}=25^{\circ}C$ and $V_{CC}=1.8V, 2.5V, 2.7V, 3.3V$ and $5.0V$ respectively.

[2] t_{pd} is the same as t_{PLH} and t_{PHL} .

3.3.5、 Transfer Characteristics 1

($T_{amb}=-40^{\circ}C$ to $+85^{\circ}C$, voltages are referenced to GND (ground = 0V), unless otherwise specified.)

Parameter	Symbol	Conditions	Min.	Typ.	Max.	Unit	
positive-going threshold voltage	V_{T+}	see Figure 6 and Figure 7	$V_{CC}=1.8V$	0.82	1.02	1.2	V
			$V_{CC}=2.3V$	1.03	1.25	1.45	V
			$V_{CC}=3.0V$; see Figure 8	1.29	1.5	1.71	V
			$V_{CC}=4.5V$	1.84	2.15	2.41	V
			$V_{CC}=5.5V$	2.19	2.6	2.91	V
negative-going threshold voltage	V_{T-}	see Figure 6 and Figure 7	$V_{CC}=1.8V$	0.45	0.6	0.75	V
			$V_{CC}=2.3V$	0.64	0.8	0.96	V
			$V_{CC}=3.0V$; see Figure 8	0.86	1.1	1.34	V
			$V_{CC}=4.5V$	1.35	1.75	2.09	V
			$V_{CC}=5.5V$	1.61	2.15	2.59	V
hysteresis voltage	V_H	$(V_{T+} - V_{T-})$; see Figure 6, Figure 7 and Figure 8	$V_{CC}=1.8V$	0.24	0.4	0.54	V
			$V_{CC}=2.3V$	0.26	0.4	0.57	V
			$V_{CC}=3.0V$; see Figure 8	0.27	0.42	0.64	V
			$V_{CC}=4.5V$	0.28	0.45	0.65	V
			$V_{CC}=5.5V$	0.29	0.47	0.75	V



3.3.6、 Transfer Characteristics 2

($T_{amb}=-40^{\circ}\text{C}$ to $+105^{\circ}\text{C}$, voltages are referenced to GND (ground = 0V), unless otherwise specified.)

Parameter	Symbol	Conditions	Min.	Typ.	Max.	Unit	
positive-going threshold voltage	V_{T+}	see Figure 6 and Figure 7	$V_{CC}=1.8\text{V}$	0.79	-	1.2	V
			$V_{CC}=2.3\text{V}$	1.00	-	1.45	V
			$V_{CC}=3.0\text{V}$; see Figure 8	1.26	-	1.71	V
			$V_{CC}=4.5\text{V}$	1.81	-	2.41	V
			$V_{CC}=5.5\text{V}$	2.16	-	2.91	V
negative-going threshold voltage	V_{T-}	see Figure 6 and Figure 7	$V_{CC}=1.8\text{V}$	0.45	-	0.78	V
			$V_{CC}=2.3\text{V}$	0.64	-	0.99	V
			$V_{CC}=3.0\text{V}$; see Figure 8	0.86	-	1.37	V
			$V_{CC}=4.5\text{V}$	1.35	-	2.12	V
			$V_{CC}=5.5\text{V}$	1.61	-	2.62	V
hysteresis voltage	V_H	$(V_{T+} - V_{T-})$; see Figure 6, Figure 7 and Figure 8	$V_{CC}=1.8\text{V}$	0.17	-	0.54	V
			$V_{CC}=2.3\text{V}$	0.20	-	0.57	V
			$V_{CC}=3.0\text{V}$; see Figure 8	0.21	-	0.64	V
			$V_{CC}=4.5\text{V}$	0.22	-	0.65	V
			$V_{CC}=5.5\text{V}$	0.23	-	0.75	V

4、 Testing Circuit

4.1、 AC Testing Circuit

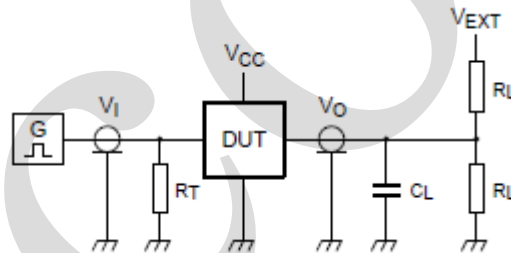

Figure 4. Test circuit for measuring switching times

Definitions for test circuit:

R_L =Load resistance.

C_L =Load capacitance including jig and probe capacitance.

R_T =Termination resistance; should be equal to the output impedance Z_o of the pulse generator.

V_{EXT} =External voltage for measuring switching times.



4.2、 AC Testing Waveforms

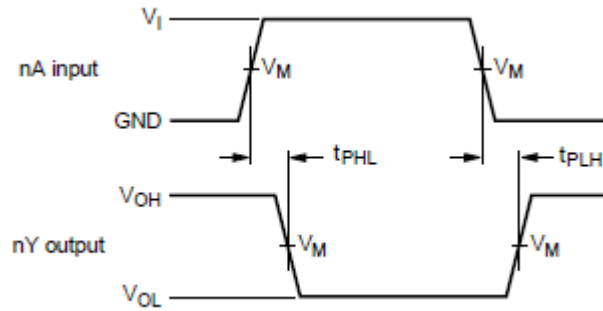

Figure 5. The input nA to output nY propagation delays

4.3、 Transfer Characteristics Waveforms

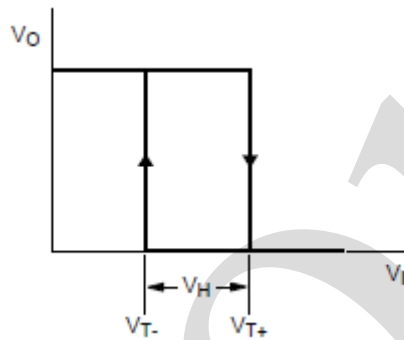

Figure 6. Transfer characteristic

V_{T+} and V_{T-} limits at 70% and 20%:

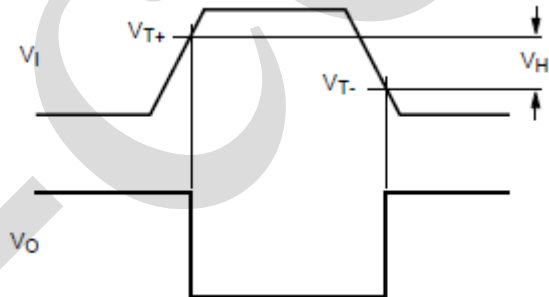

Figure 7. Definition of V_{T+} , V_{T-} and V_H



$V_{CC}=3.0V$:

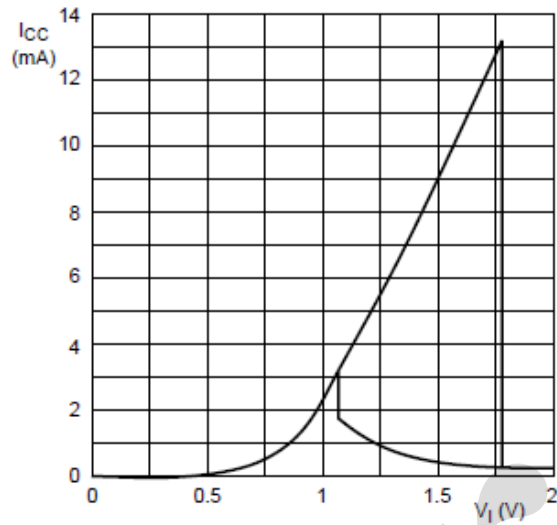

Figure 8. Typical transfer characteristics

4.4. Measurement Points

Supply voltage	Input	Output
V_{CC}	V_M	V_M
1.65V to 1.95V	$0.5 \times V_{CC}$	$0.5 \times V_{CC}$
2.3V to 2.7V	$0.5 \times V_{CC}$	$0.5 \times V_{CC}$
2.7V	1.5V	1.5V
3.0V to 3.6V	1.5V	1.5V
4.5V to 5.5V	$0.5 \times V_{CC}$	$0.5 \times V_{CC}$

4.5. Test Data

Supply voltage	Input		Load		V_{EXT}
V_{CC}	V_I	$t_r = t_f$	C_L	R_L	t_{PLH}, t_{PHL}
1.65V to 1.95V	V_{CC}	$\leq 2.0ns$	30pF	1k Ω	open
2.3V to 2.7V	V_{CC}	$\leq 2.0ns$	30pF	500 Ω	open
2.7V	2.7V	$\leq 2.5ns$	50pF	500 Ω	open
3.0V to 3.6V	2.7V	$\leq 2.5ns$	50pF	500 Ω	open
4.5V to 5.5V	V_{CC}	$\leq 2.5ns$	50pF	500 Ω	open



5、Package Information

5.1、SOT-23-6

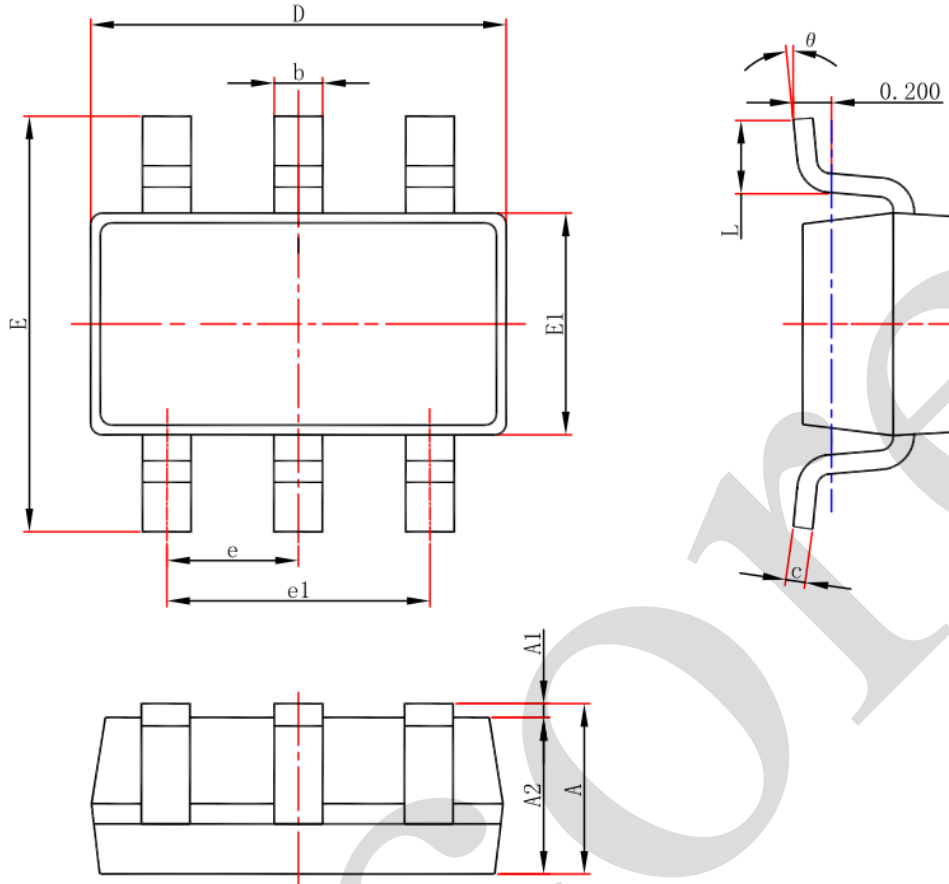

Symbol	Dimensions In Millimeters		Dimensions In Inches	
	Min.	Max.	Min.	Max.
A	1.050	1.250	0.041	0.049
A1	0.000	0.100	0.000	0.004
A2	1.050	1.150	0.041	0.045
b	0.300	0.500	0.012	0.020
c	0.100	0.200	0.004	0.008
D	2.820	3.020	0.111	0.119
E1	1.500	1.700	0.059	0.067
E	2.650	2.950	0.104	0.116
e	0.950(BSC)		0.037(BSC)	
e1	1.800	2.000	0.071	0.079
L	0.300	0.600	0.012	0.024
θ	0°	8°	0°	8°



5.2、SOT-363

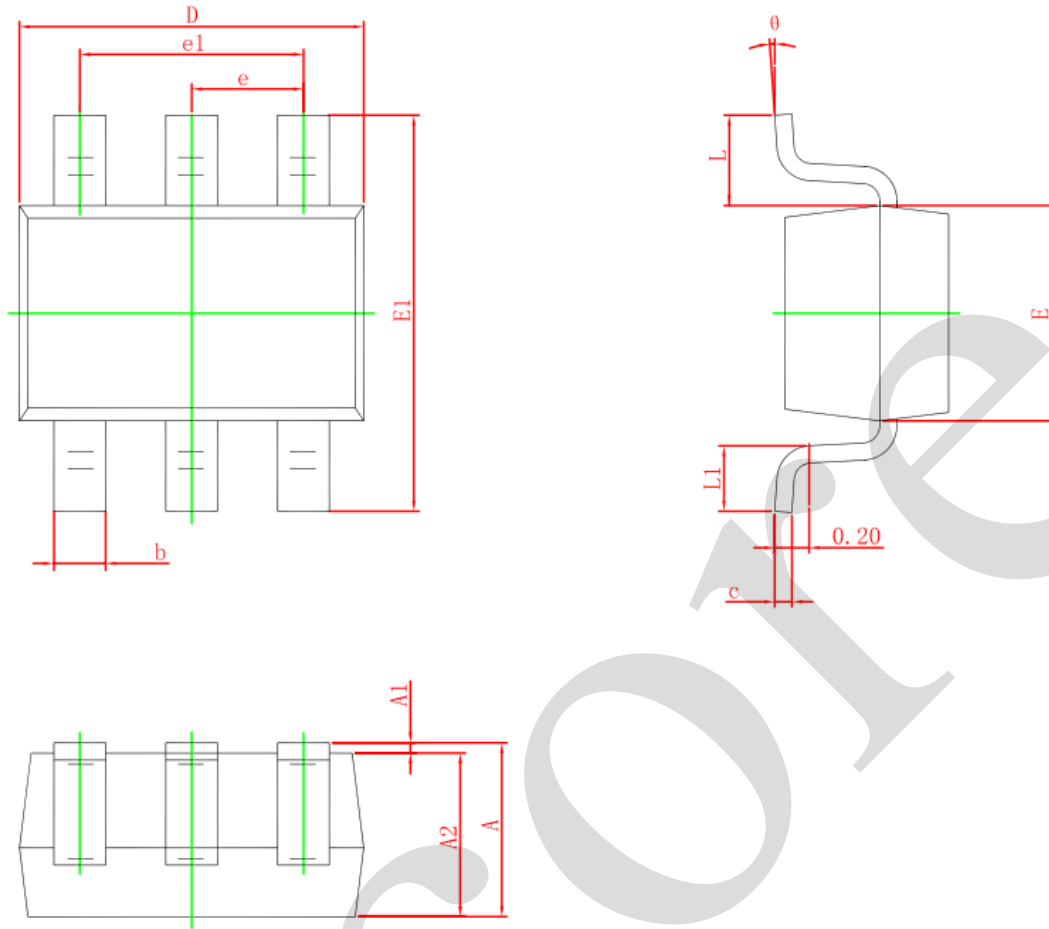

Symbol	Dimensions In Millimeters		Dimensions In Inches	
	Min.	Max.	Min.	Max.
A	0.900	1.100	0.035	0.043
A1	0.000	0.100	0.000	0.004
A2	0.900	1.000	0.035	0.039
b	0.150	0.350	0.006	0.014
c	0.080	0.150	0.003	0.006
D	2.000	2.200	0.079	0.087
E	1.150	1.350	0.045	0.053
E1	2.150	2.450	0.085	0.096
e	0.650 TYP.		0.026 TYP.	
e1	1.200	1.400	0.047	0.055
L	0.525 REF.		0.021 REF.	
L1	0.260	0.460	0.010	0.018
θ	0°	8°	0°	8°



6、 Statements And Notes

6.1、 The name and content of Hazardous substances or Elements in the product

Part name	Hazardous substances or Elements									
	Lead and lead compounds	Mercury and mercury compounds	Cadmium and cadmium compounds	Hexavalent chromium compounds	Polybrominated biphenyls	Polybrominated biphenyl ethers	Dibutyl phthalate	Butylbenzyl phthalate	Di-2-ethylhexyl phthalate	Diisobutyl phthalate
Lead frame	○	○	○	○	○	○	○	○	○	○
Plastic resin	○	○	○	○	○	○	○	○	○	○
Chip	○	○	○	○	○	○	○	○	○	○
The lead	○	○	○	○	○	○	○	○	○	○
Plastic sheet installed	○	○	○	○	○	○	○	○	○	○
explanation	○: Indicates that the content of hazardous substances or elements in the detection limit of the following the SJ/T11363-2006 standard. ×: Indicates that the content of hazardous substances or elements exceeding the SJ/T11363-2006 Standard limit requirements.									

6.2、 Notion

Recommended carefully reading this information before the use of this product;

The information in this document are subject to change without notice;

This information is using to the reference only, the company is not responsible for any loss;

The company is not responsible for the any infringement of the third party patents or other rights of the responsibility.