

Applications

- High and Low Side Switches for Inverter
- High and Low Side Switches for Generic Half-Bridge

Features

N-Channel

- $V_{DS} (V) = 30V$
- $I_D = 6.8A (V_{GS} = 10V)$
- $R_{DS(ON)} < 27m\Omega (V_{GS} = 10V)$

P-Channel

- $V_{DS} (V) = -30V$
- $I_D = -4.6A (V_{GS} = -10V)$
- $R_{DS(ON)} < 64m\Omega (V_{GS} = -10V)$

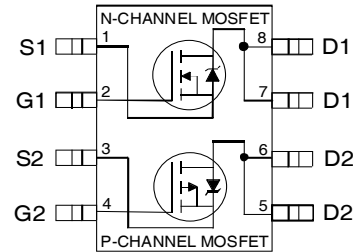

Top View

Absolute Maximum Ratings

	Parameter	Max.		Units
		N-Channel	P-Channel	
V_{GS}	Gate-to-Source Voltage	± 20	± 20	V
$I_D @ T_A = 25^\circ C$	Continuous Drain Current, $V_{GS} @ 10V$	6.8	-4.6	A
$I_D @ T_A = 70^\circ C$	Continuous Drain Current, $V_{GS} @ 10V$	5.4	-3.7	
I_{DM}	Pulsed Drain Current ①	34	-23	
$P_D @ T_A = 25^\circ C$	Power Dissipation	2.0		W
$P_D @ T_A = 70^\circ C$	Power Dissipation	1.3		
	Linear Derating Factor	0.016		
T_J	Operating Junction and	-55 to + 150		$^\circ C$
T_{STG}	Storage Temperature Range			

Thermal Resistance

	Parameter	Typ.	Max	Units
$R_{\theta JL}$	Junction-to-Drain Lead ④		20	$^\circ C/W$
$R_{\theta JA}$	Junction-to-Ambient ③		62.5	

Static @ T_J = 25°C (unless otherwise specified)

	Parameter		Min.	Typ.	Max.	Units	
BV _{DSS}	Drain-to-Source Breakdown Voltage	N-Ch	30			V	V _{GS} = 0V, I _D = 250μA
		P-Ch	-30				V _{GS} = 0V, I _D = -250μA
ΔBV _{DSS} /ΔT _J	Breakdown Voltage Temp. Coefficient	N-Ch		0.03		V/°C	Reference to 25°C, I _D = 1mA
		P-Ch		0.02			Reference to 25°C, I _D = -1mA
R _{DS(on)}	Static Drain-to-Source On-Resistance	N-Ch		22	27	mΩ	V _{GS} = 10V, I _D = 6.8A ③
				33	40		V _{GS} = 4.5V, I _D = 5.4A ③
		P-Ch		51	64	mΩ	V _{GS} = -10V, I _D = -4.6A ③
				82	103		V _{GS} = -4.5V, I _D = -3.7A ③
V _{GS(th)}	Gate Threshold Voltage	N-Ch	1.3	1.8	2.3	V	V _{DS} = V _{GS} , I _D = 10μA
		P-Ch	-1.3	-1.8	-2.3		V _{DS} = V _{GS} , I _D = -10μA
I _{DSS}	Drain-to-Source Leakage Current	N-Ch			1.0	μA	V _{DS} = 24V, V _{GS} = 0V
		P-Ch			-1.0		V _{DS} = -24V, V _{GS} = 0V
		N-Ch			150		V _{DS} = 24V, V _{GS} = 0V, T _J = 125°C
		P-Ch			-150		V _{DS} = -24V, V _{GS} = 0V, T _J = 125°C
I _{GSS}	Gate-to-Source Forward Leakage	N-Ch			100	nA	V _{GS} = 20V
		P-Ch			-100		V _{GS} = -20V
	Gate-to-Source Reverse Leakage	N-Ch			-100		V _{GS} = -20V
		P-Ch			100		V _{GS} = 20V
g _{fs}	Forward Transconductance	N-Ch	8.2			S	V _{DS} = 15V, I _D = 5.4A
		P-Ch	4.1				V _{DS} = -15V, I _D = -3.7A
Q _g	Total Gate Charge	N-Ch		6.8	14	nC	N-Channel V _{GS} = 10V, V _{DS} = 15V, I _D = 6.8A
		P-Ch		8.1	16		P-Channel V _{GS} = -10V, V _{DS} = -15V, I _D = -4.6A
Q _{gs}	Gate-to-Source Charge	N-Ch		1.4			
		P-Ch		1.3			
Q _{gd}	Gate-to-Drain ("Miller") Charge	N-Ch		0.98			
		P-Ch		2.1			
R _G	Gate Resistance	N-Ch		2.2	4.4	Ω	
		P-Ch		9.4	19		
t _{d(on)}	Turn-On Delay Time	N-Ch		5.1		ns	N-Channel V _{DD} = 15V, V _{GS} = 4.5V ③ I _D = 1.0A, R _G = 6.2
		P-Ch		8.0			
t _r	Rise Time	N-Ch		4.8			
		P-Ch		14			
t _{d(off)}	Turn-Off Delay Time	N-Ch		4.9			P-Channel V _{DD} = -15V, V _{GS} = -4.5V ③ I _D = -1.0A, R _G = 6.8
		P-Ch		17			
t _f	Fall Time	N-Ch		3.9			
		P-Ch		15			
C _{iss}	Input Capacitance	N-Ch		398		pF	N-Channel V _{GS} = 0V, V _{DS} = 15V, f = 1.0MHz
		P-Ch		383			
C _{oss}	Output Capacitance	N-Ch		82			P-Channel V _{GS} = 0V, V _{DS} = -15V, f = 1.0KHz
		P-Ch		104			
C _{rss}	Reverse Transfer Capacitance	N-Ch		36			
		P-Ch		64			

Diode Characteristics

	Parameter		Min.	Typ.	Max.	Units	Conditions
I _S	Continuous Source Current (Body Diode)	N-Ch			2.0	A	
		P-Ch			-2.0		
I _{SM}	Pulsed Source Current (Body Diode)	N-Ch			34		
		P-Ch			-23		
V _{SD}	Diode Forward Voltage	N-Ch			1.2	V	T = 25°C, I = 2.0A, V _{GS} = 0V ③
		P-Ch			-1.2		T = 25°C, I = -2.0A, V _{GS} = 0V ③
t _{rr}	Reverse Recovery Time	N-Ch		8.4	13	ns	N-Channel: T = 25°C, I = 2.0A, V _{DD} = 15V, di/dt = 102/μs ③
		P-Ch		11	17		
Q _{rr}	Reverse Recovery Charge	N-Ch		2.3	3.5	nC	P-Channel: T = 25°C, I = -2.0A, V _{DD} = -15V, di/dt = 102/μs ③
		P-Ch		4.8	7.2		

Notes:

- ① Repetitive rating; pulse width limited by max. junction temperature. (See fig. 16)
- ② Pulse width ≤ 400μs; duty cycle ≤ 2%.

- ③ Surface mounted on 1 in square Cu board
- ④ R_θ is measured at T_J approximately 90°C

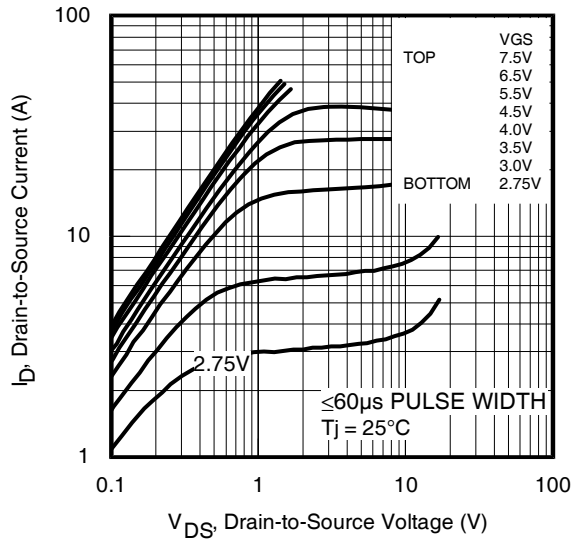

Fig 1. Typical Output Characteristics

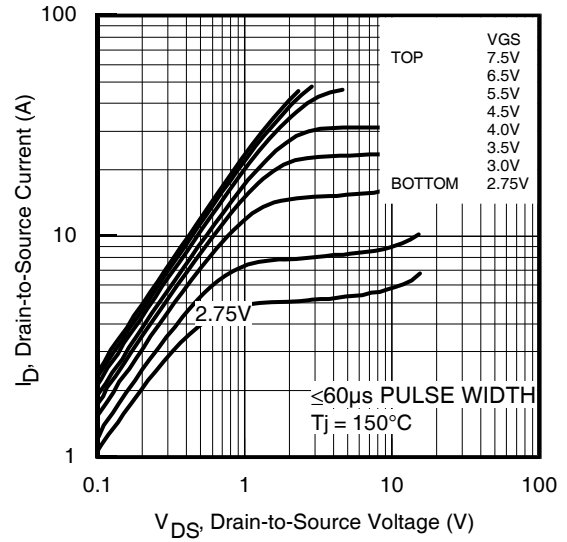

Fig 2. Typical Output Characteristics

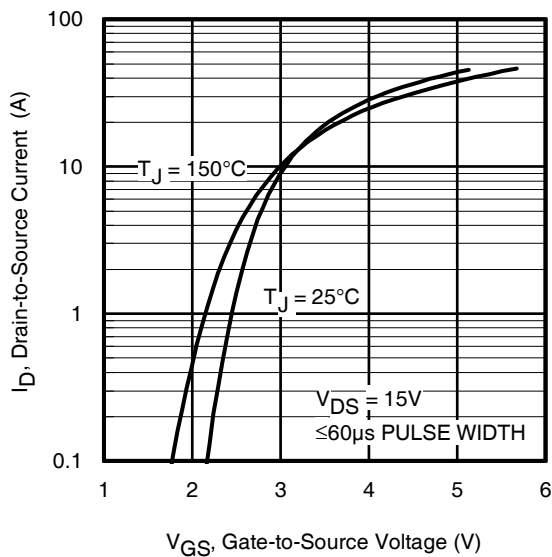

Fig 3. Typical Transfer Characteristics

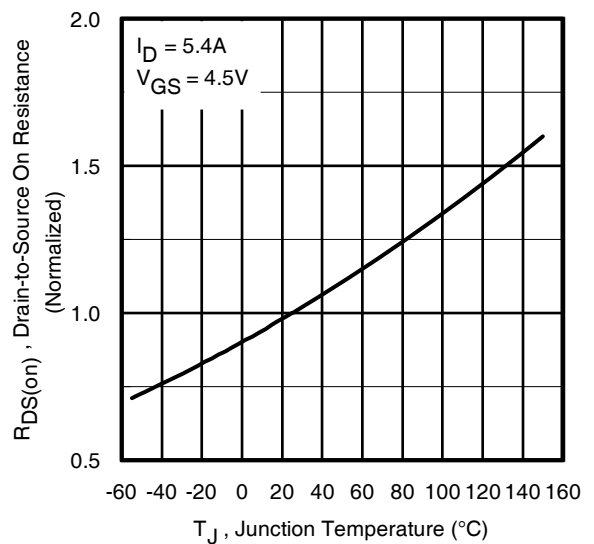

Fig 4. Normalized On-Resistance vs. Temperature

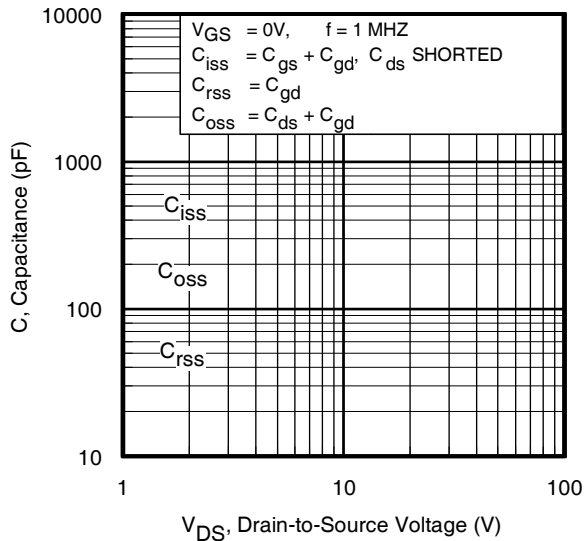

Fig 5. Typical Capacitance vs. Drain-to-Source Voltage

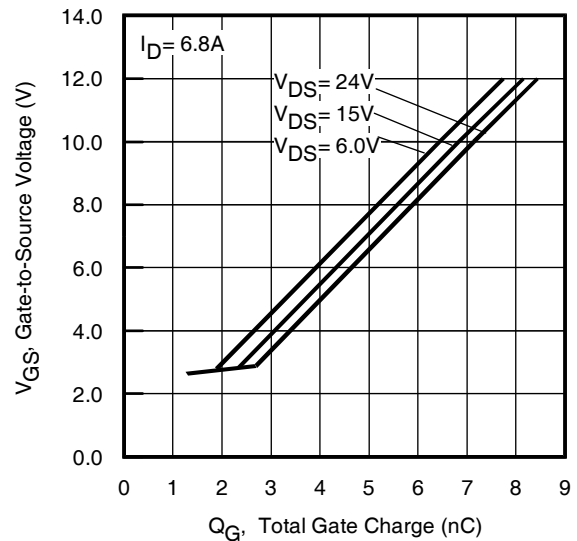

Fig 6. Typical Gate Charge vs. Gate-to-Source Voltage

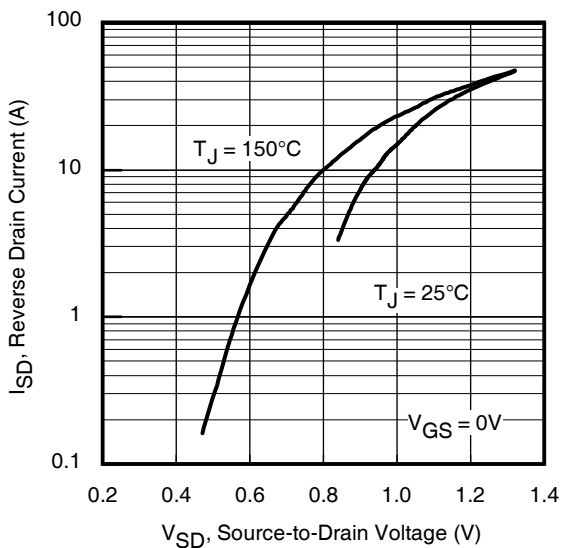

Fig 7. Typical Source-Drain Diode Forward Voltage

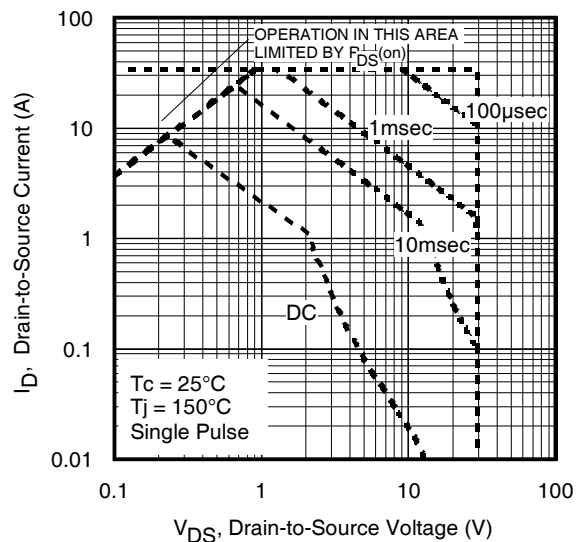

Fig 8. Maximum Safe Operating Area

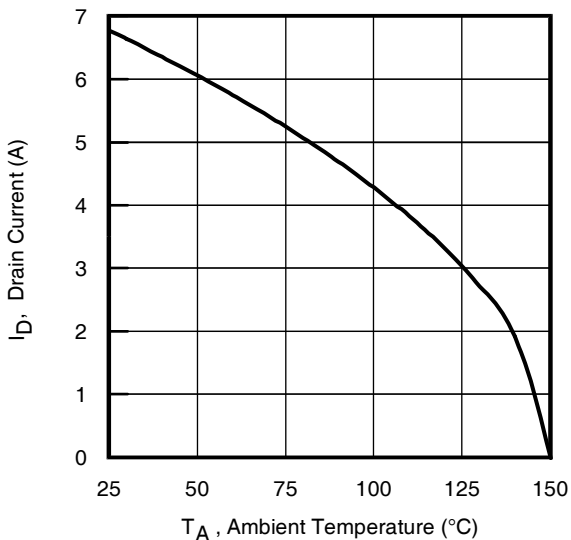

Fig 9. Maximum Drain Current vs. Ambient Temperature

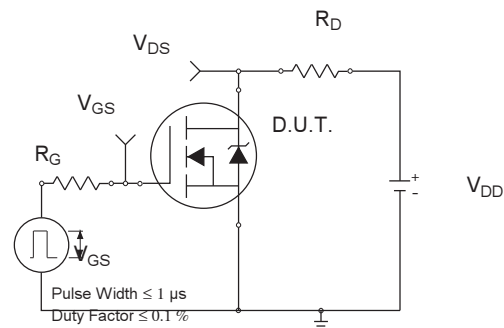

Fig 10a. Switching Time Test Circuit

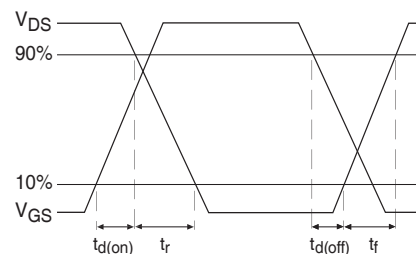

Fig 10b. Switching Time Waveforms

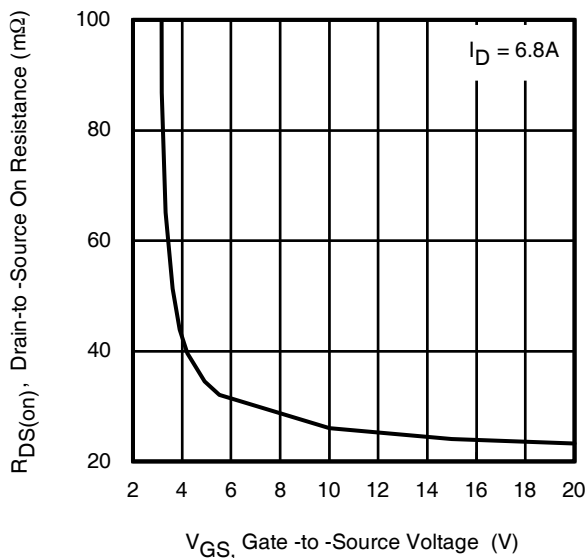

Fig 11. Typical On-Resistance vs. Gate Voltage

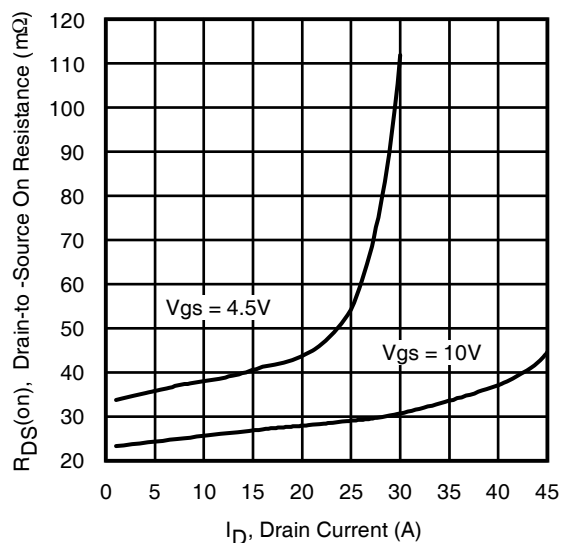

Fig 12. Typical On-Resistance vs. Drain Current

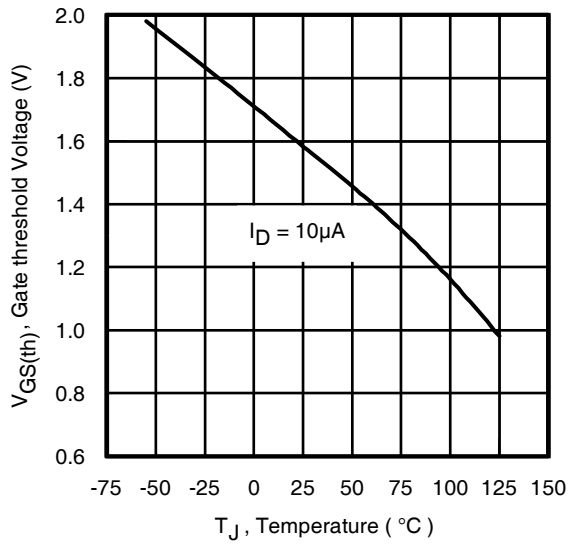

Fig 13. Threshold Voltage vs. Temperature

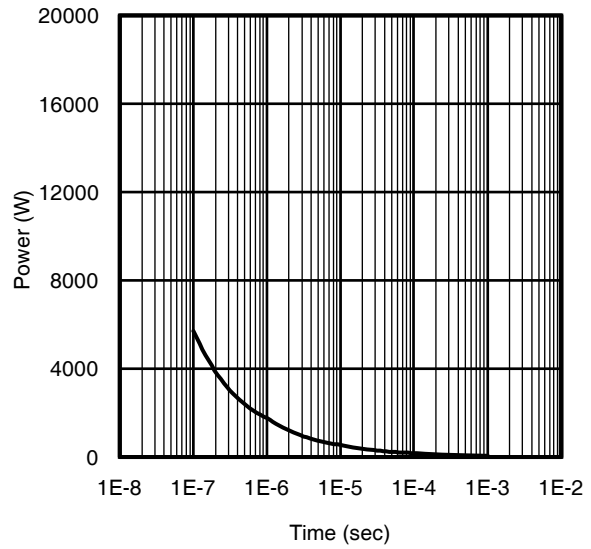

Fig 14. Typical Power vs. Time

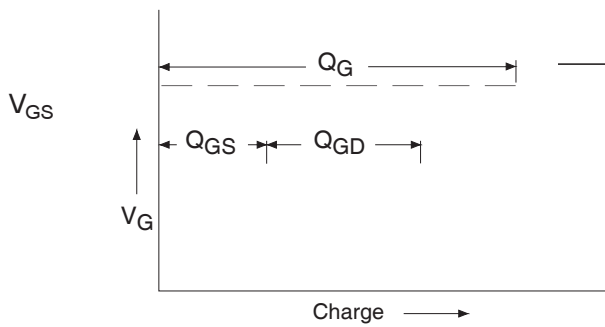

Fig 15a. Basic Gate Charge Waveform

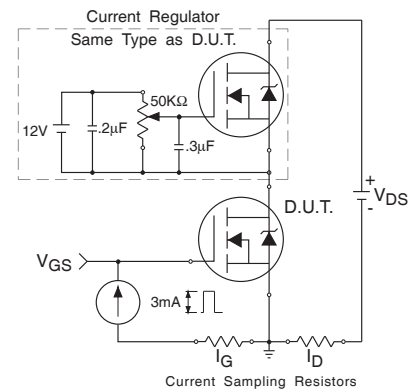

Fig 15b. Gate Charge Test Circuit

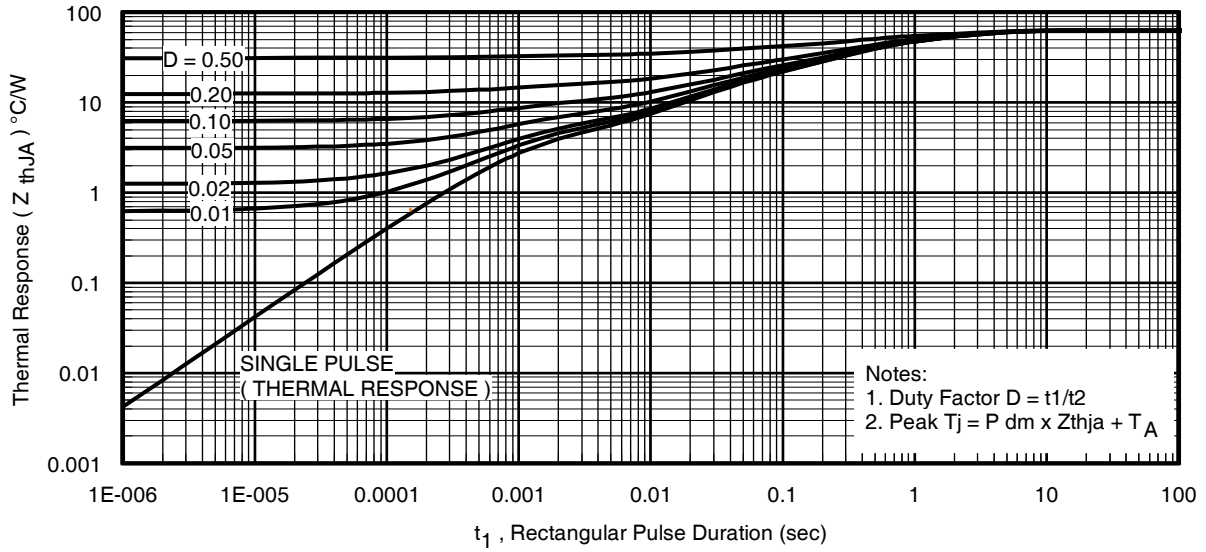

Fig 16. Typical Effective Transient Thermal Impedance, Junction-to-Ambient

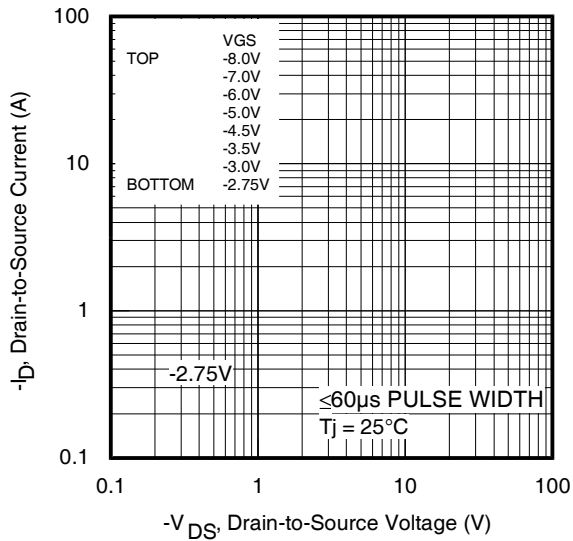

Fig 17. Typical Output Characteristics

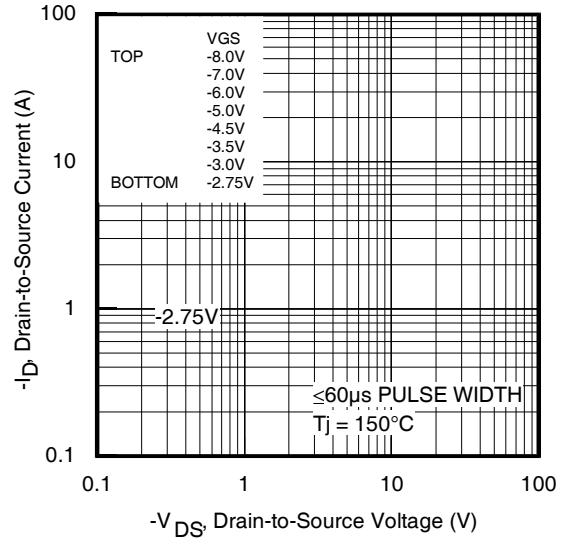

Fig 18. Typical Output Characteristics

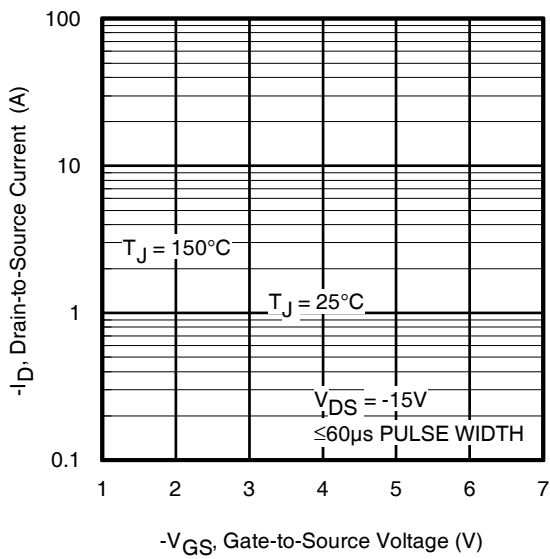

Fig 19. Typical Transfer Characteristics

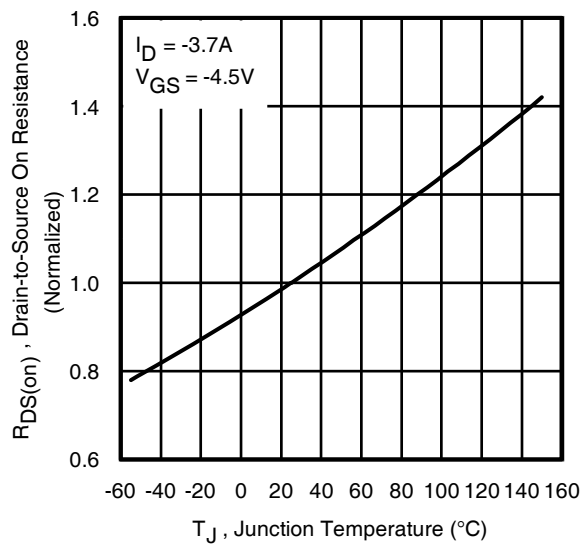

Fig 20. Normalized On-Resistance vs. Temperature

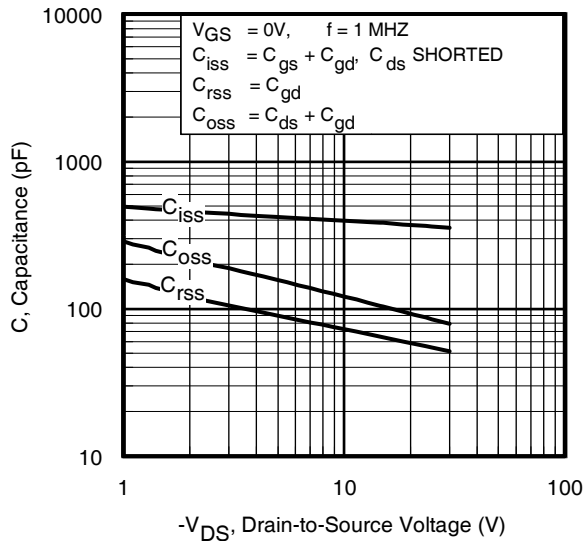

Fig 21. Typical Capacitance vs. Drain-to-Source Voltage

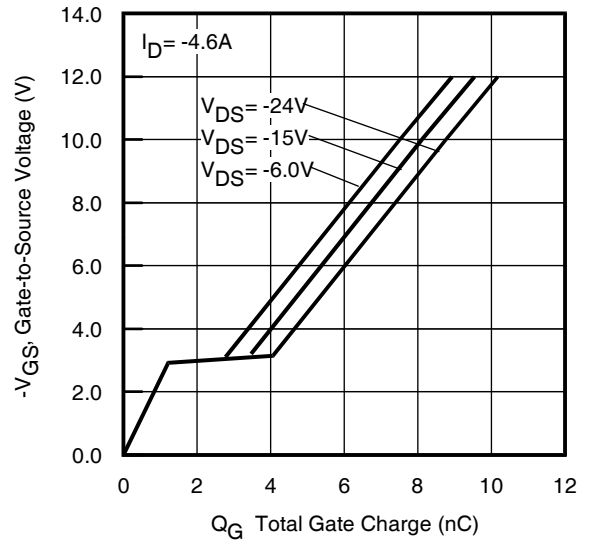

Fig 22. Typical Gate Charge vs. Gate-to-Source Voltage

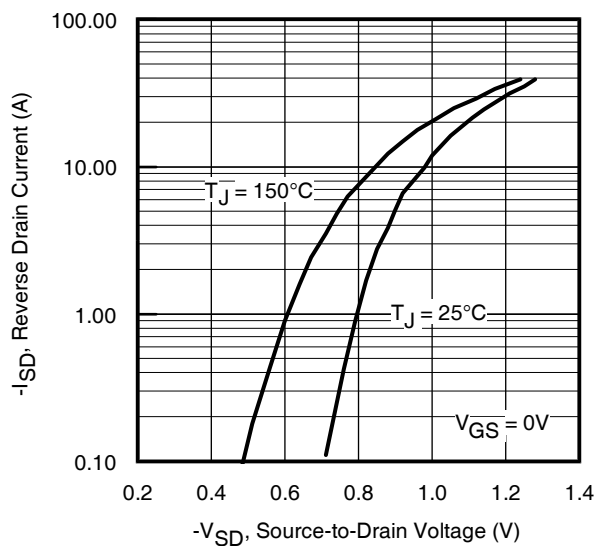

Fig 23. Typical Source-Drain Diode Forward Voltage

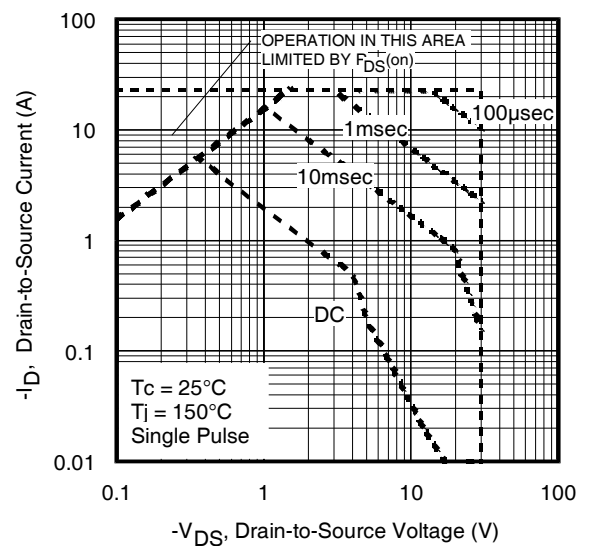

Fig 24. Maximum Safe Operating Area

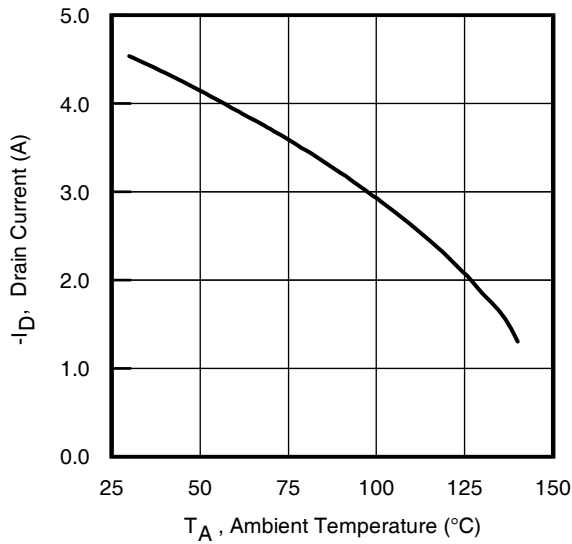

Fig 25. Maximum Drain Current vs. Ambient Temperature

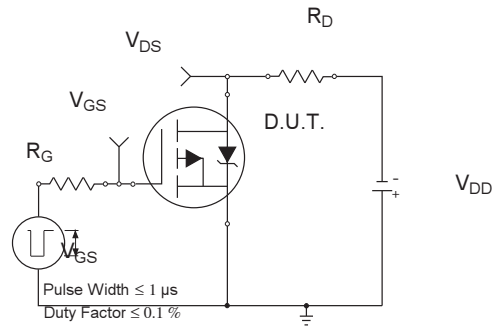

Fig 26a. Switching Time Test Circuit

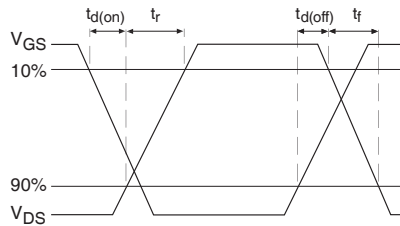

Fig 26b. Switching Time Waveforms

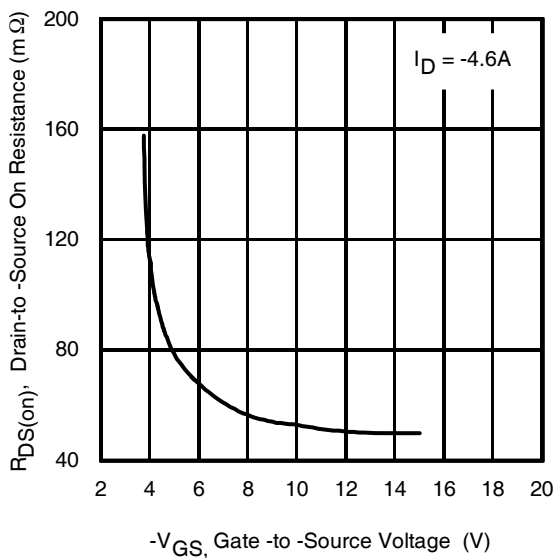

Fig 27. Typical On-Resistance vs. Gate Voltage

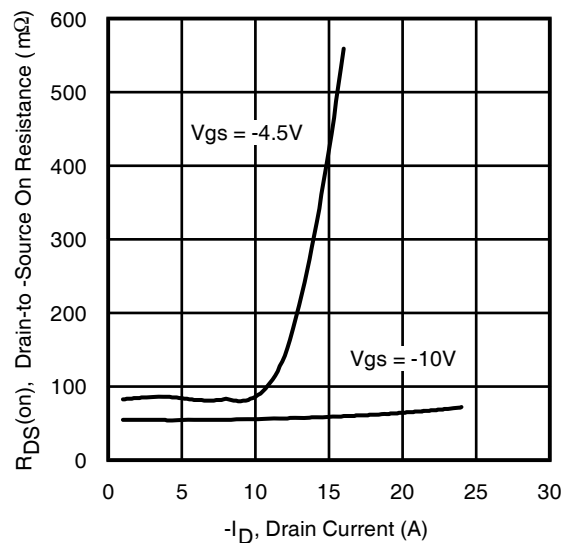

Fig 28. Typical On-Resistance vs. Drain Current

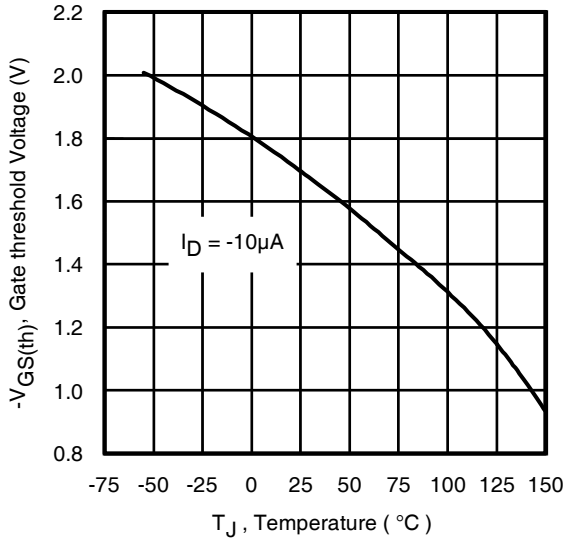

Fig 29. Threshold Voltage vs. Temperature

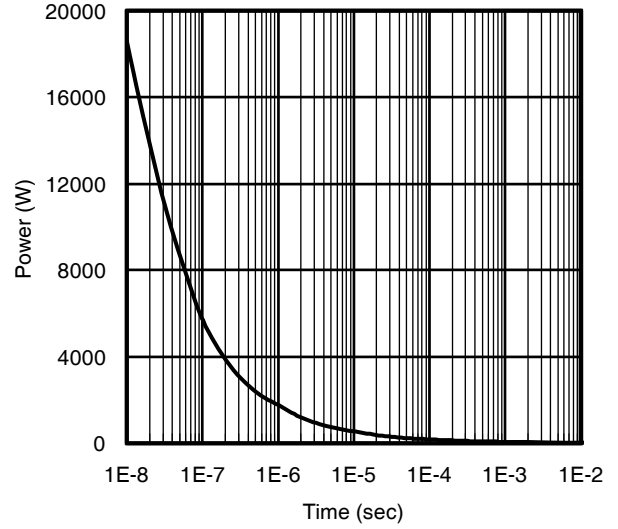

Fig 30. Typical Power vs. Time

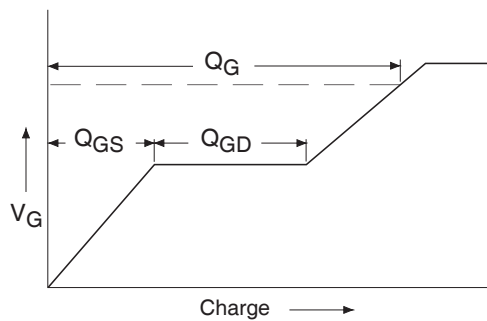

Fig 31a. Basic Gate Charge Waveform

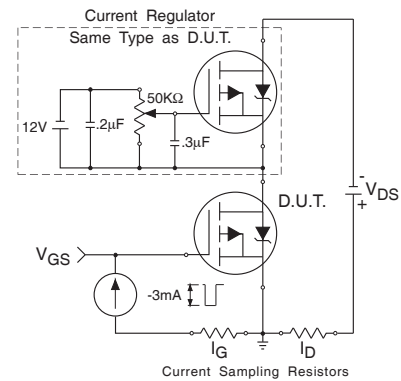
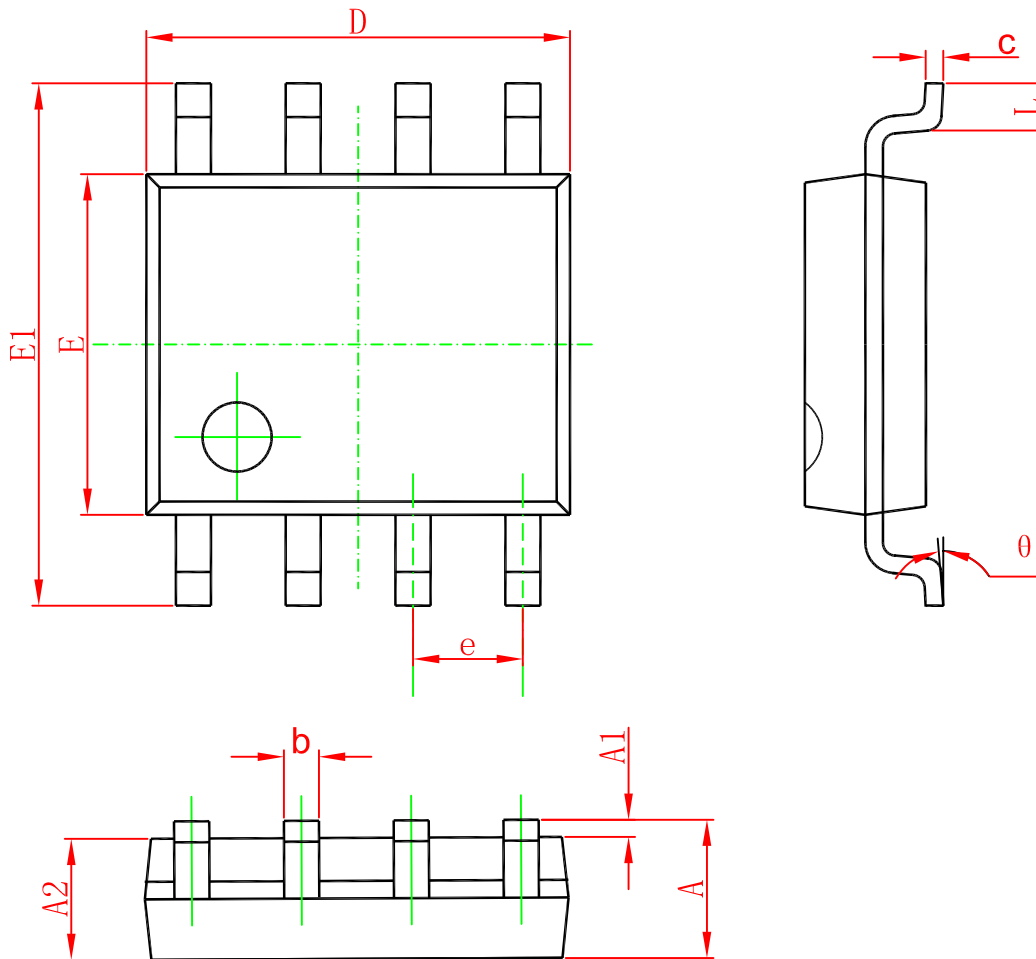

Fig 31b. Gate Charge Test Circuit

Package Mechanical Data SOP-8



Symbol	Dimensions In Millimeters		Dimensions In Inches	
	Min	Max	Min	Max
A	1.350	1.750	0.053	0.069
A1	0.100	0.250	0.004	0.010
A2	1.350	1.550	0.053	0.061
b	0.330	0.510	0.013	0.020
c	0.170	0.250	0.006	0.010
D	4.700	5.100	0.185	0.200
E	3.800	4.000	0.150	0.157
E1	5.800	6.200	0.228	0.244
e	1.270(BSC)		0.050(BSC)	
L	0.400	1.270	0.016	0.050
θ	0°	8°	0°	8°

Marking

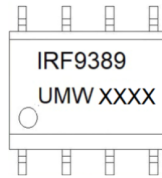

Ordering information

Order code	Package	Baseqty	Deliverymode
UMW IRF9389TR	SOP-8	3000	Tape and reel