



为您的产品保驾护航

PRODUCT DATASHEET

Electro-Static Discharge

JED323-24V-LG ESD

## Features

- Package: SOD-323
- 360W peak pulse power (8/20 $\mu$ s)
- Ultra low capacitance: 1pF typical
- Ultra low leakage: nA level
- Operating voltage: 24V
- Low clamping voltage
- Protects one power line or data line
- Complies with following standards:
  - IEC 61000-4-2 (ESD) immunity test  
Air discharge:  $\pm 30$ kV  
Contact discharge:  $\pm 30$ kV
  - IEC61000-4-5 (Lightning) 6A (8/20 $\mu$ s)
- RoHS compliant

## Applications

- USB Ports
- Smart Phones
- Wireless Systems
- Ethernet 10/100/1000 Base T

## Schematic Diagram

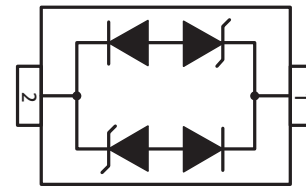

## Pin Description



## Limiting Values ( $T_A = 25^\circ\text{C}$ , unless otherwise specified)

Symbol	Parameter	Conditions	Value	Unit
V <sub>ESD</sub>	Electrostatic Discharge Voltage	IEC 61000-4-2; Contact Discharge	$\pm 30$	kV
		IEC 61000-4-2; Air Discharge	$\pm 30$	kV
P <sub>PK</sub>	Peak Pulse Power	t <sub>P</sub> =8/20 $\mu$ s	360	W
I <sub>PP</sub>	Peak Pulse Current	t <sub>P</sub> =8/20 $\mu$ s	6	A
T <sub>J</sub>	Operating Temperature Range	-	-55 to +125	$^\circ\text{C}$
T <sub>stg</sub>	Storage Temperature Range	-	-55 to +150	$^\circ\text{C}$

## Electrical Characteristics ( $T_A = 25^\circ\text{C}$ , unless otherwise specified)

Symbol	Parameter	Conditions	Min	Typ.	Max	Unit
V <sub>RWM</sub>	Reverse Working Voltage	T <sub>A</sub> =25 $^\circ\text{C}$	-	-	24	V
V <sub>BR</sub>	Snap-Back Voltage	I <sub>T</sub> =1mA; T <sub>A</sub> =25 $^\circ\text{C}$	27	-	-	V
I <sub>R</sub>	Reverse Leakage Current	V <sub>RWM</sub> =12V; T <sub>A</sub> =25 $^\circ\text{C}$	-	-	0.2	$\mu\text{A}$
V <sub>C</sub>	Clamping Voltage	I <sub>PP</sub> =1A(8x20 $\mu$ s pulse)	-	36	-	V
V <sub>C</sub>	Clamping Voltage	I <sub>PP</sub> =6A(8x20 $\mu$ s pulse)	-	55	-	V
C <sub>J</sub>	Junction Capacitance	V <sub>R</sub> =0V, f=1 MHz	-	1	-	pF

Typical Characteristics

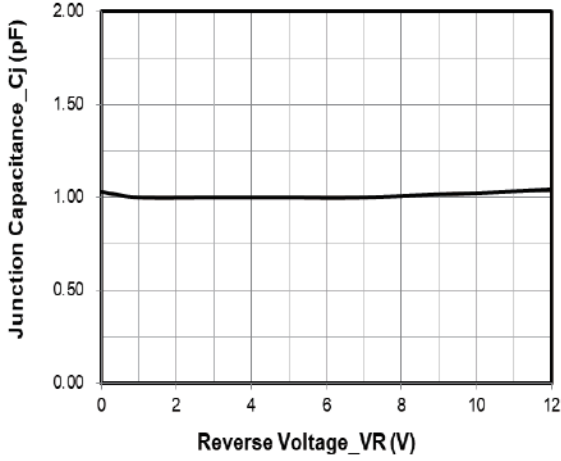

Junction Capacitance vs. Reverse Voltage

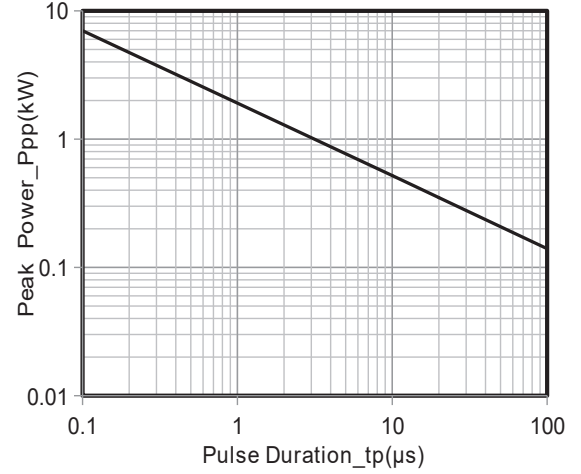

Peak Pulse Power vs. Pulse Time

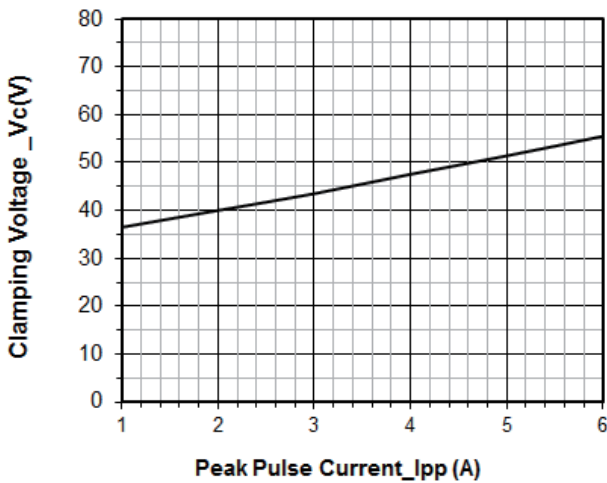

Clamping Voltage vs. Peak Pulse Current (tp = 8/20 μs)

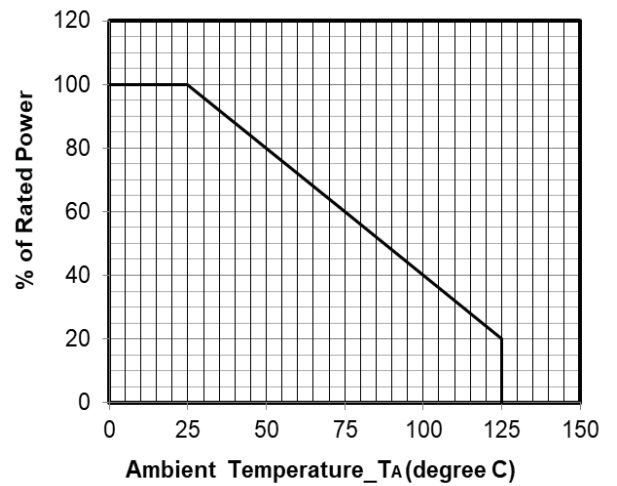

Power Derating Curve

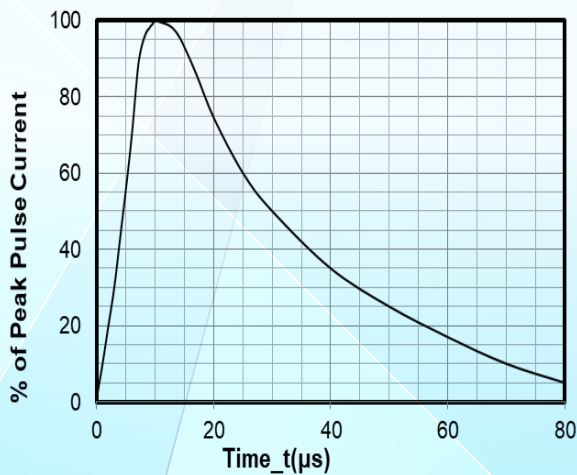

8x20 μs Pulse Waveform

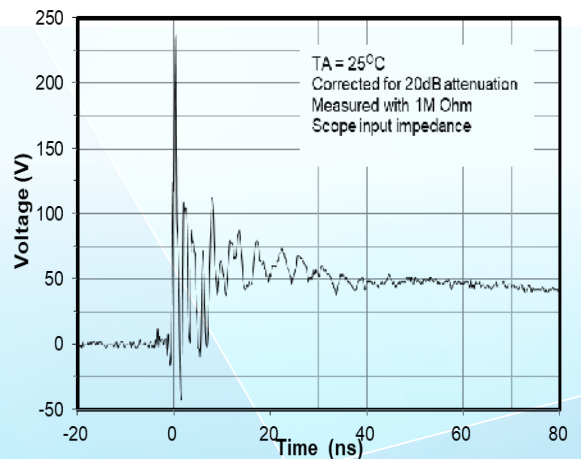

ESD Clamping Voltage  
8 kV Contact per IEC61000-4-2

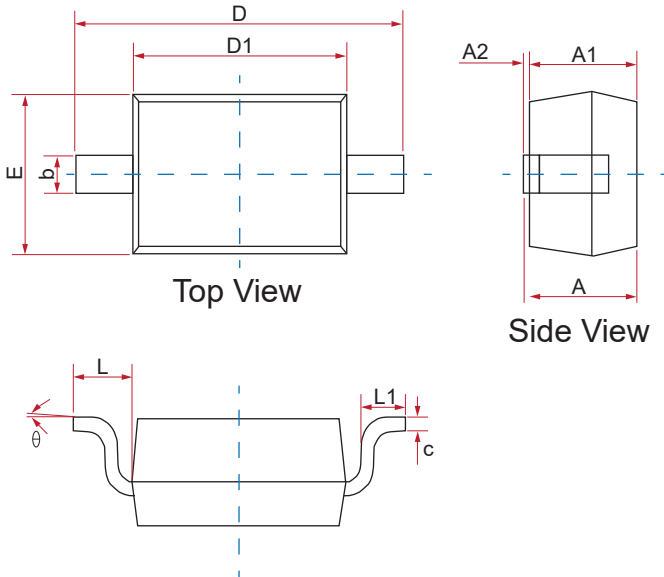
**Physical Dimensions(mm.)**

Symbol	Dimensions In Millimeters		
	Min	Nom	Max
A	0.80	--	1.100
A1	0.80	--	0.900
A2	0.00	--	0.100
b	0.25	--	0.400
c	0.08	--	0.177
D1	1.60	1.70	1.800
D	2.30	--	2.800
E	1.15	--	1.400
L	0.475REF		
L1	0.10	--	0.500
θ	0°	--	8°

**Suggested Land Pattern**

Unit:mm

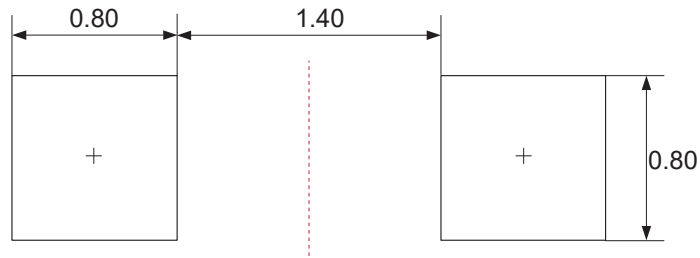
**Packaging Quantity**

Part Number	Delivery Form	Delivery Quantity
JED323-24V-LC	7"T&R	3,000

### Soldering Parameters

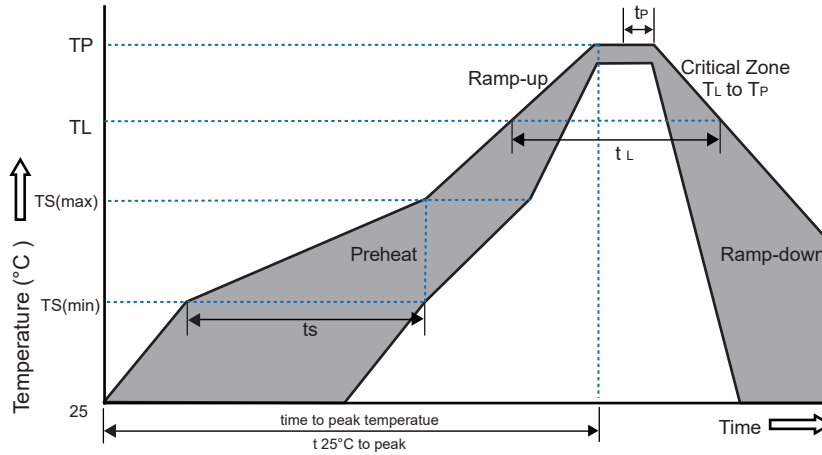

Reflow Condition		Pb-Free Assembly
Pre-heat	-Temperature Min( $T_{s(min)}$ )	+150°C
	-Temperature Max( $T_{s(max)}$ )	+200°C
	-Time(Min to Max)( $t_s$ )	60~180 secs.
Average ramp up rate (Liquid us Temp( $T_L$ ) to peak)		3°C/sec. Max
Ts(max) to $T_L$ - Ramp-up Rate		3°C/sec. Max
Reflow	-Temperature( $T_L$ )(Liquid us)	+217°C
	-Temperature ( $t_L$ )	60~150 secs.
Peak Temp ( $T_p$ )		+260(+0/-5)°C
Time within 5°C of actual Peak Temp ( $t_p$ )		30 secs. Max
Ramp-down Rate		6°C/sec. Max
xTime 25°C to Peak Temp (TP)		8 min. Max
Do not exceed		+260°C

### Part Number System

## JE D323 - 24V - L C

C=Bi-directional  
Blank=Uni-directional

L=Low Capacitance

Working Voltage: 24V

SOD-323

JDT ESD