



Features

- High Linearity: OIP3=49dBm (880MHz)
- Low Noise: NF=3.1dB (2140MHz)
- P1dB>29dBm
- 400MHz to 2700MHz Operation
- Thermally Enhanced Slug Package

Applications

- GaAs Pre-Driver for Base Station Amplifiers
- PA Stage for Commercial Wireless Infrastructure
- Class AB Operation for DCS, PCS, UMTS, LTE, and WLAN Transceiver Applications
- 2nd/3rd Stage LNA for Wireless Infrastructure

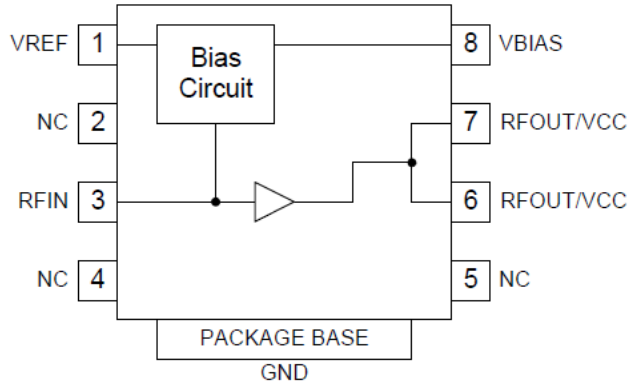

Functional Block Diagram

Product Description

The RFPA3809 is a GaAs HBT linear power amplifier specifically designed for Wireless Infrastructure applications. Using a highly reliable GaAs HBT fabrication process, this high performance single-stage amplifier achieves ultra-high linearity over a broad frequency range. It also offers low noise figure making it an excellent solution for 2nd and 3rd stage LNAs. The RFPA3809 also exhibits excellent thermal performance through the use of a thermally-enhanced plastic surface-mount slug package.

Ordering Information

RFPA3809SQ	Sample Bag with 25 pieces
RFPA3809SR	7" Reel with 100 pieces
RFPA3809TR13	13" Reel with 2500 pieces
RFPA3809PCK-410	869MHz to 894MHz PCBA with 5-piece Sample Bag
RFPA3809PCK-411	2110MHz to 2170MHz PCBA with 5-piece Sample Bag

Optimum Technology Matching® Applied

- | | | | |
|--|--------------------------------------|-------------------------------------|------------------------------------|
| <input checked="" type="checkbox"/> GaAs HBT | <input type="checkbox"/> SiGe BiCMOS | <input type="checkbox"/> GaAs pHEMT | <input type="checkbox"/> GaN HEMT |
| <input type="checkbox"/> GaAs MESFET | <input type="checkbox"/> Si BiCMOS | <input type="checkbox"/> Si CMOS | <input type="checkbox"/> BIFET HBT |
| <input type="checkbox"/> InGaP HBT | <input type="checkbox"/> SiGe HBT | <input type="checkbox"/> Si BJT | <input type="checkbox"/> LDMOS |

RF MICRO DEVICES®, RFMD®, Optimum Technology Matching®, Enabling Wireless Connectivity™, PowerStart®, POLARIS™ TOTAL RADIO™ and UltimateBlue™ are trademarks of RFMD, LLC. BLUETOOTH is a trademark owned by Bluetooth SIG, Inc., U.S.A. and licensed for use by RFMD. All other trade names, trademarks and registered trademarks are the property of their respective owners. ©2006, RF Micro Devices, Inc.

Absolute Maximum Ratings

Parameter	Rating	Unit
Supply Voltage (V_{CC} and V_{BIAS})	6.5	V
Reference Current (I_{REF})	5	mA
DC Supply Current (I_C)	768	mA
CW Input Power, 2:1 Output VSWR	26	dBm
Output Load VSWR at P3dB	5:1	
Operating Junction Temperature	160	°C
Operating Temperature Range (T_L)	-40 to +85	°C
Storage Temperature	-55 to +150	°C
ESD Rating: Human Body Model	Class 1B	
Moisture Sensitivity Level	MSL 2	



Caution! ESD sensitive device.

Exceeding any one or a combination of the Absolute Maximum Rating conditions may cause permanent damage to the device. Extended application of Absolute Maximum Rating conditions to the device may reduce device reliability. Specified typical performance or functional operation of the device under Absolute Maximum Rating conditions is not implied.

RoHS status based on EUDirective2002/95/EC (at time of this document revision).

The information in this publication is believed to be accurate and reliable. However, no responsibility is assumed by RF Micro Devices, Inc. ("RFMD") for its use, nor for any infringement of patents, or other rights of third parties, resulting from its use. No license is granted by implication or otherwise under any patent or patent rights of RFMD. RFMD reserves the right to change component circuitry, recommended application circuitry and specifications at any time without prior notice.

- Notes: 1. The maximum ratings must all be met simultaneously.
 2. $P_{diss} = P_{DC} + P_{RFIN} - P_{RFOUT}$
 3. $T_j = T_L + P_{diss} * R_{th}$

Parameter	Specification			Unit	Condition
	Min.	Typ.	Max.		
869 MHz to 894 MHz					
Frequency	869	880	894	MHz	$V_{CC}=5.0V, V_{BIAS}=5.0V, I_{CQ}=275mA$
Input Power (P_{IN})			18	dBm	Max recommended, $V_{CC} < 6.0V$
Gain (S21)		17		dB	
OIP3		49		dBm	15 dBm/tone, tone spacing = 1 MHz
P1dB		29		dBm	
Efficiency at P3dB		58		%	At P3dB, EVB tuned for linear operation
Input Return Loss (S11)		16		dB	
Output Return Loss (S22)		18		dB	
Noise Figure		3.9		dB	
WCDMA Ch Power at -65 dBc ACPR		17		dBm	3GPP 3.5, Test Model 1, 64 DPCH
WCDMA Ch Power at -55 dBc ACPR		19.3		dBm	3GPP 3.5, Test Model 1, 64 DPCH
UMTS2100					
Frequency	2110	2140	2170	MHz	$V_{CC}=5.0V, V_{BIAS}=5.0V, I_{CQ}=275mA$
Input Power (P_{IN})			20	dBm	Max recommended, $V_{CC} < 6.0V$
Gain (S21)		12.4		dB	
OIP3		47		dBm	15 dBm/tone, tone spacing = 1 MHz
P1dB		29		dBm	
Efficiency at P3dB		50		%	At P3dB, EVB tuned for linear operation
Input Return Loss (S11)		17		dB	
Output Return Loss (S22)		15		dB	
Noise Figure		3.1		dB	
WCDMA Ch Power at -65 dBc ACPR		16.5		dBm	3GPP 3.5, Test Model 1, 64 DPCH
WCDMA Ch Power at -55 dBc ACPR		19		dBm	3GPP 3.5, Test Model 1, 64 DPCH
Power Supply					
Operating Current (Quiescent)	230	275	380	mA	At $V_{CC}=5.0V$
Operating Voltage (V_{CC})		5.0	6.0	V	Max recommended collector voltage
Thermal Resistance (R_{TH})		38		C/W	At quiescent current, no RF
Power Down Current			20	uA	At $V_{REF}=0V$

Typical Performance
(869MHz to 894MHz Application Circuit)

S11 versus Frequency

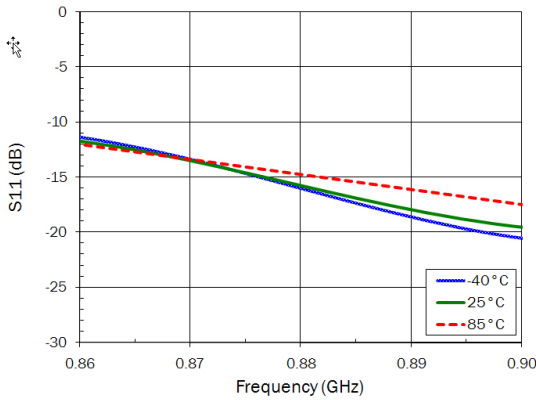

S21 versus Frequency

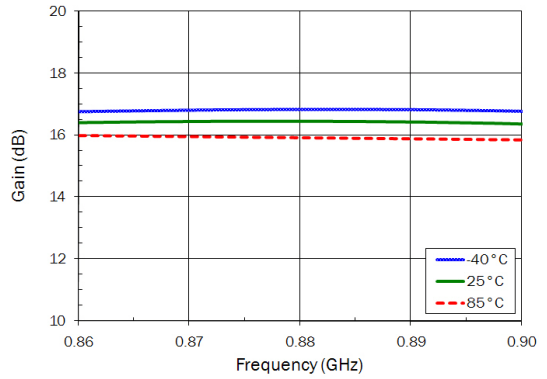

S12 versus Frequency

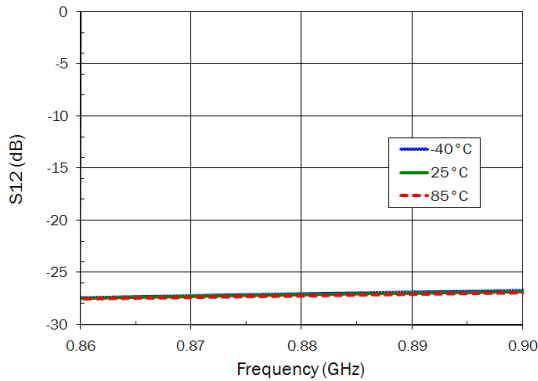

S22 versus Frequency

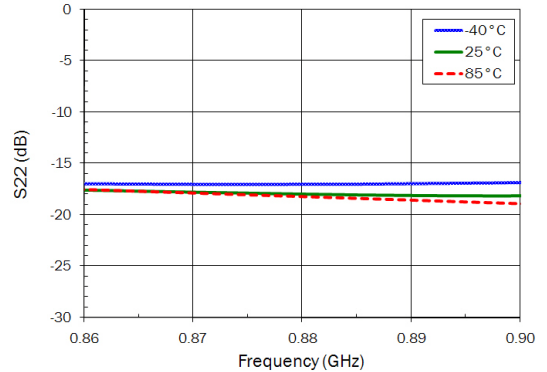

Noise Figure versus Frequency

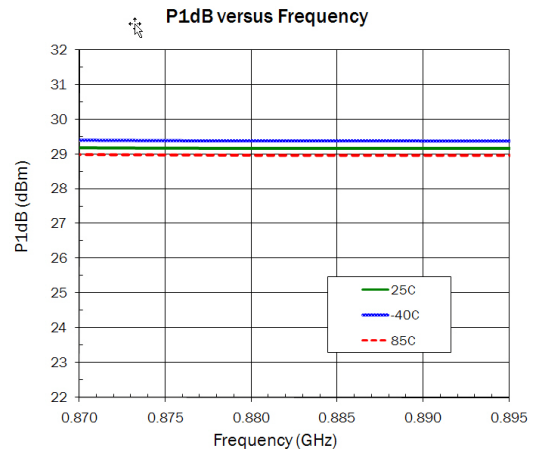

Typical Performance (869 MHz to 894 MHz Application Circuit)

OIP3 vs Freq. (15dBm tones, 1 MHz spacing)

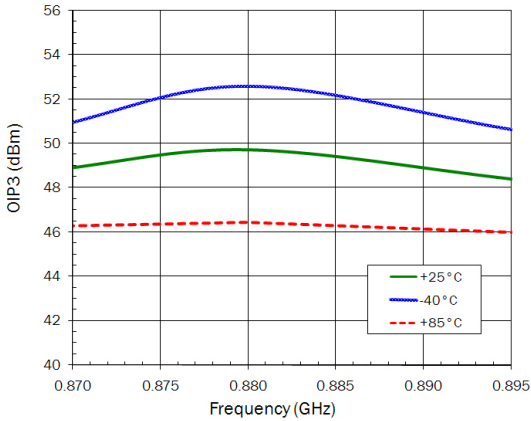

Pout versus Pin @ 880MHz

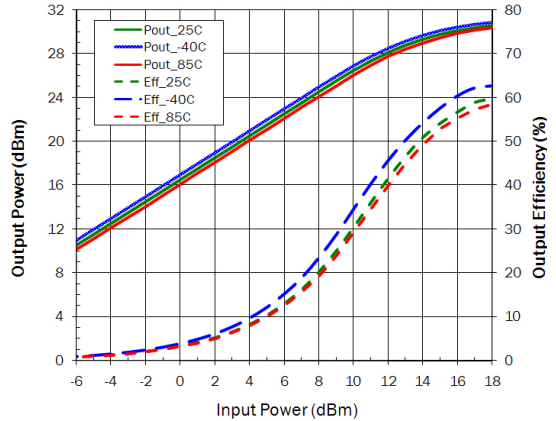

OIP3 vs Tone Power (880MHz, 1 MHz spacing)

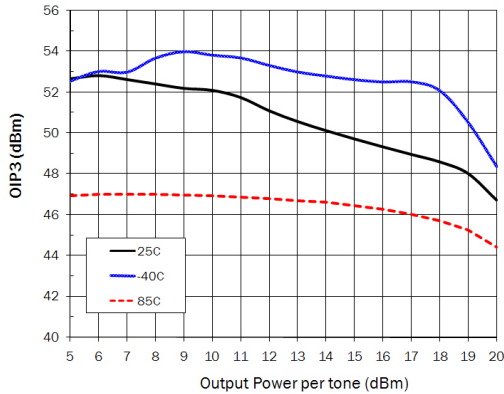

OIP3 vs Tone Power (1MHz spacing)

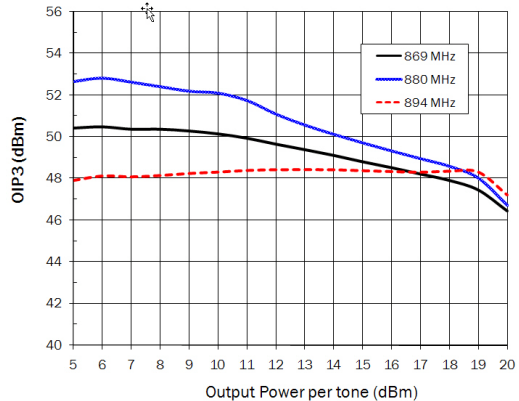

ACP versus WCDMA Channel Power (880MHz)

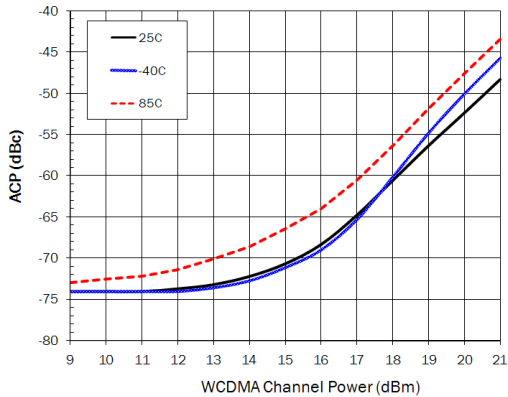

ACP versus WCDMA Channel Power (25C)

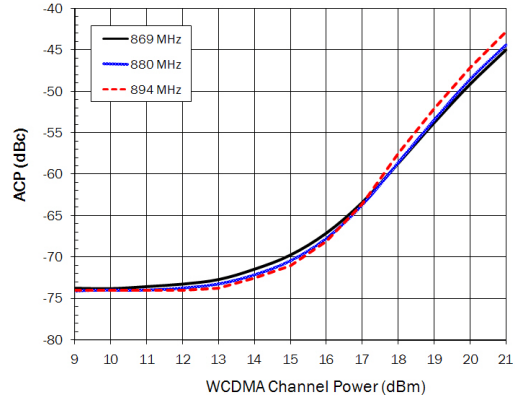

Evaluation Board Schematic
(869MHz to 894MHz Application Circuit)

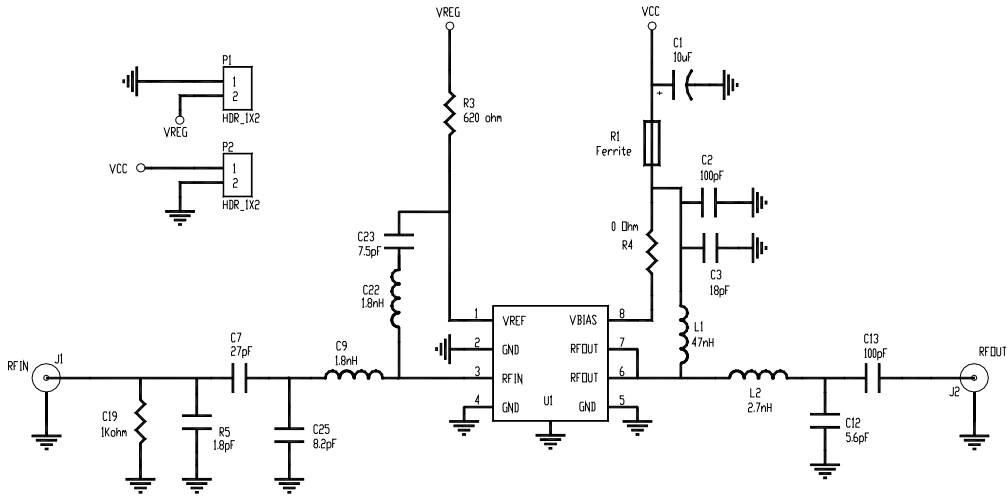

EVB BOM

(869MHz to 894MHz Application Circuit)

Description	Reference Designator	Manufacturer	Manufacturer's P/N
PCB, PA380X410			PA380X410(A)
CAP, 10 μ F, 10%, 10V, TANT-A	C1	AVX Corporation	TAJA106K010R
CAP, 100pF, 5%, 50V, COG, 0402	C2	Taiyo Yuden (USA), Inc.	RM UMK105CG101JV-F
CAP, 18pF, 5%, 50V, COG, 0402	C3	Taiyo Yuden (USA), Inc.	RM UMK105 CG180JV-F
CAP, 7.5pF, \pm 0.5pF, 50V, COG, 0402	C23	Taiyo Yuden (USA), Inc.	RM UMK105CG7R5DW
CAP, 1.8pF, \pm 0.25pF, 50V, COG, 0402	R5	Taiyo Yuden (USA), Inc.	RM UMK105CG1R8CW
CAP, 27pF, 5%, 50V, COG, 0402	C7	Taiyo Yuden (USA), Inc.	RM UMK105CG270JV-F
CAP, 8.2pF, \pm 0.5pF, 50V, COG, 0402	C25	Taiyo Yuden (USA), Inc.	RM UMK105 CG8R2DV-F
CAP, 5.6pF, \pm 0.25pF, 50V, HI-Q, 0402	C12	Johanson Technology	500R07S5R6CV4TD
CAP, 100pF, 5%, 50V, COG, 0402	C13	Murata Electronics	GRM1555C1H101JZ01D
IND, 47nH, 5% W/W, 0603	L1	Coilcraft	0603HC-47NXJLW
IND, 1.8nH, \pm 0.3nH, M/L, 0402	C9, C22	Toko America, Inc.	LL1005-FH1N8S
IND, 2.7nH, \pm 0.3nH, M/L, 0402	L2	Toko America, Inc.	LL1005-FH2N7S
CONN. SMA, END, LAUNCH, RND, PIN, 0.062"	J1, J2	GIGALANE CO., LTD.	PAF-S05-008
CONN, HDR, ST, 2-PIN, 0.100"	P1, P2	Sullins Electronics	PBC02SAAN
RFPA3809SB	U1	RFMD	RFPA3809
FER, BEAD, 260 Ω , 5%, 1/16W, 0402	R1	Murata Electronics	BLM18EG221SN1D
RES, 620 Ω , 5%, 1/16W, 0402	R3	PANASONIC INDUSTRIAL	ERJ-2GEJ621X
RES, 0 Ω , 0603	R4	Kamaya, Inc.	RMC1/16JPTP
RES, 1K, 5%, 1/16W, 0402	C19	Kamaya, Inc.	RMC1/16S-102JTH
SCREW, 2-56X3/16", SOCKET HEAD	S1, S2, S3, S4, S5	McMaster-Carr Supply Co.	92196A076
Heatsink Block 1.16 sq. in.		RFMD	EEF-102059(B)
DNP	C4-C6, C8, C10, C11, C14-C18, C20, C21, C24, C26-C29, R2 R6-R8		

Evaluation Board Assembly Drawing (869 MHz to 894 MHz Application Circuit)

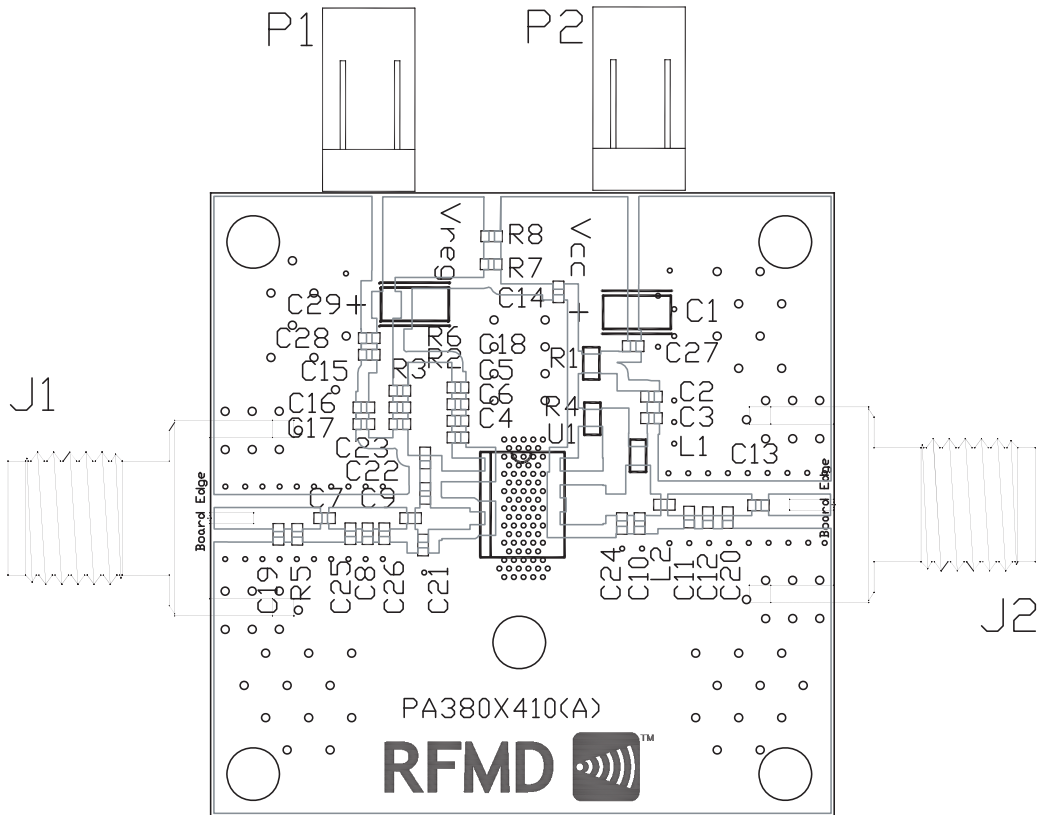

Typical Performance
(2110MHz to 2170MHz Application Circuit)

S11 versus Frequency

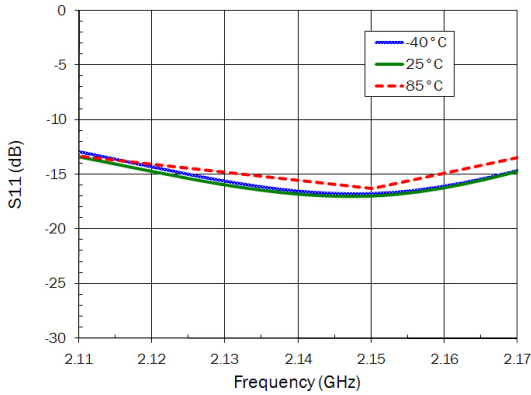

S21 versus Frequency

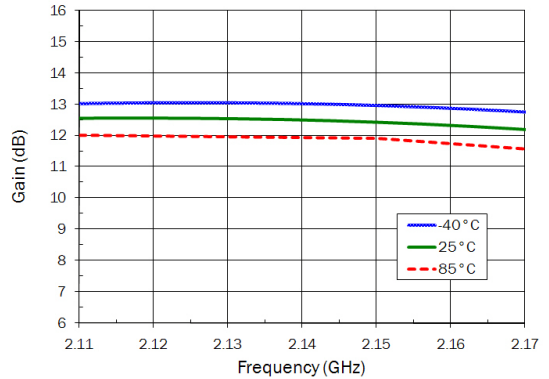

S12 versus Frequency

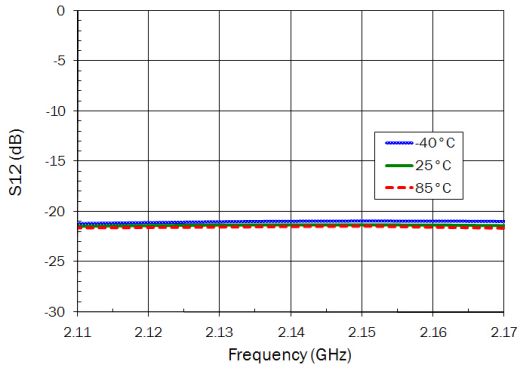

S22 versus Frequency

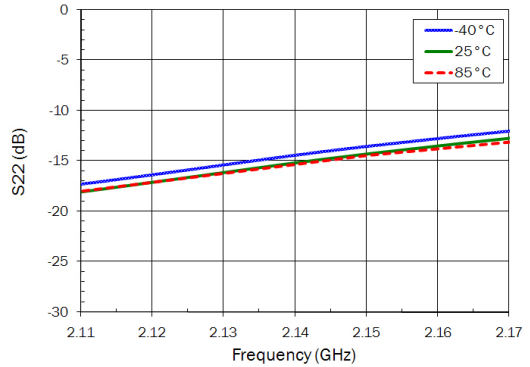

Noise Figure versus Frequency

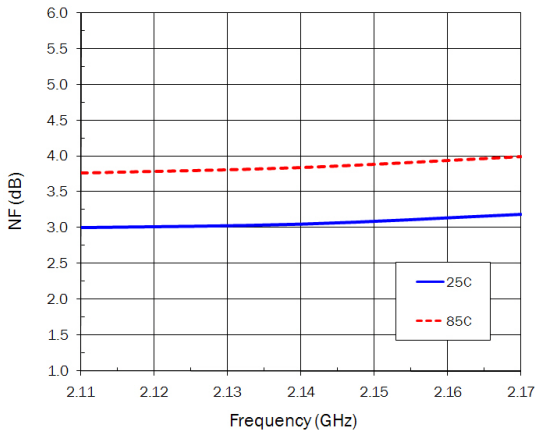

P1dB versus Frequency

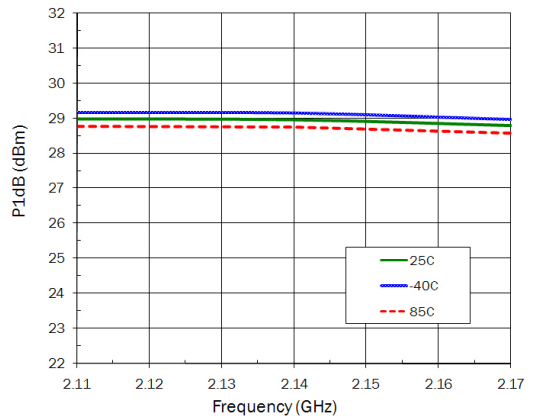

Typical Performance (2110 MHz to 2170 MHz Application Circuit)

OIP3 vs Freq. (15dBm tones, 1 MHz spacing)

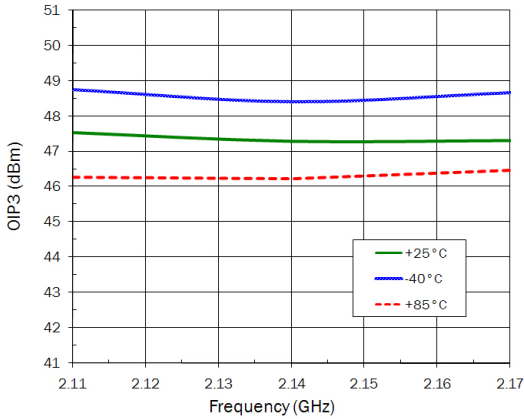

Pout versus Pin @ 2140MHz

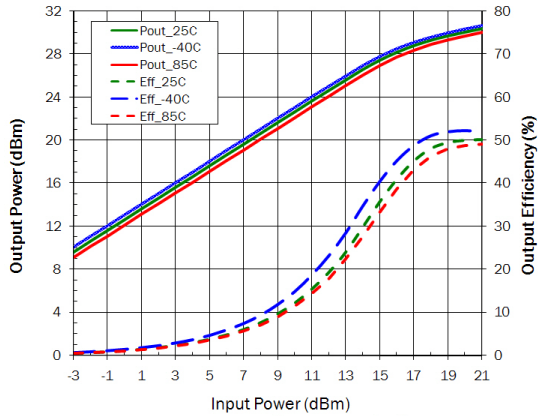

OIP3 vs Tone Power (2140MHz, 1 MHz spacing)

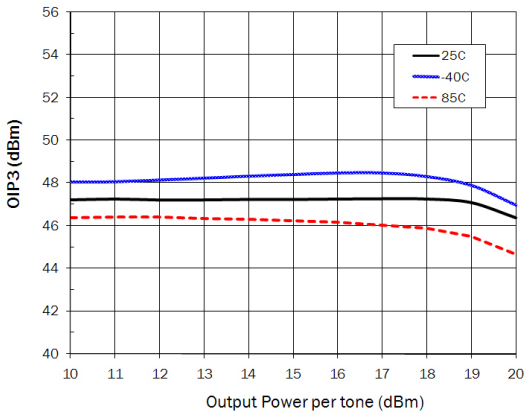

OIP3 vs Tone Power (1MHz spacing)

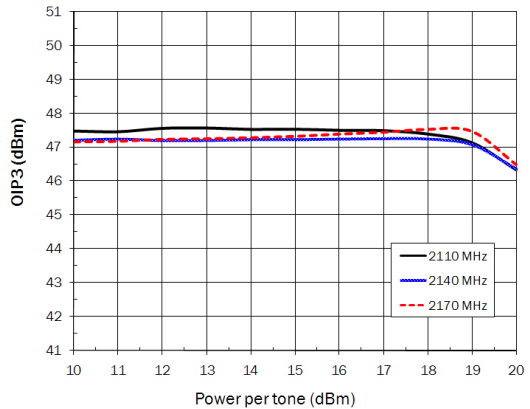

ACP versus WCDMA Channel Power (2140MHz)

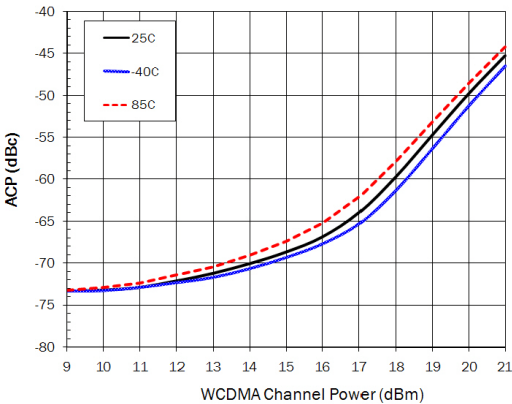

ACP versus WCDMA Channel Power

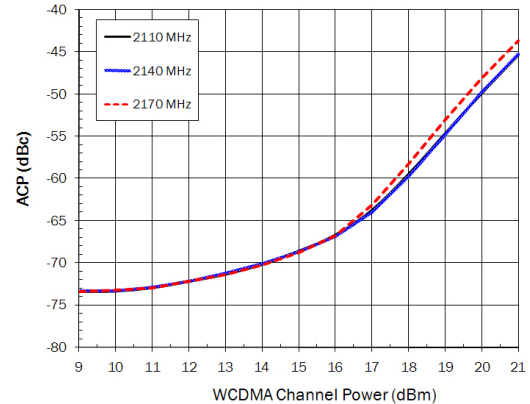

Evaluation Board Schematic
(2110MHz to 2170MHz Application Circuit)

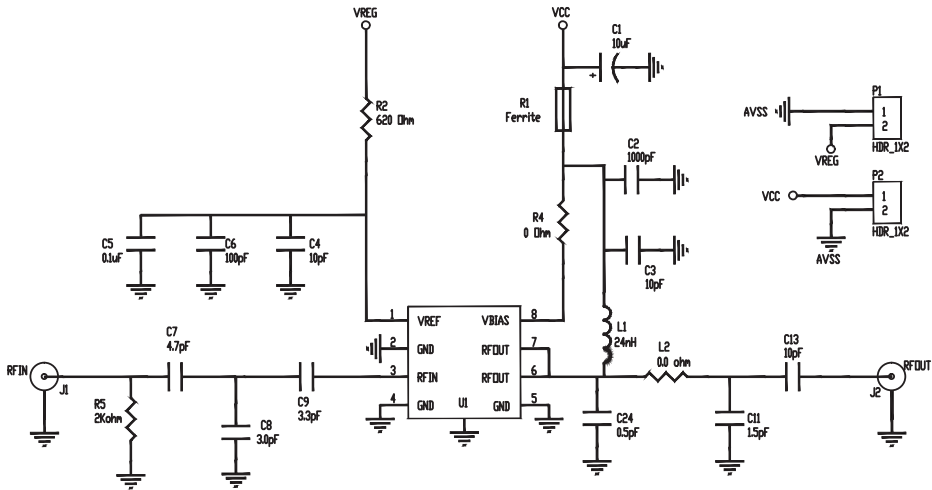

EVB BOM

(2110MHz to 2170MHz Application Circuit)

Description	Reference Designator	Manufacturer	Manufacturer's P/N
PCB, PA380X410			PA380X410(A)
CAP, 10µF, 10%, 10V, TANT-A	C1	AVX Corporation	TAJA106K010R
CAP, 1000pF, 10%, 50V, X7R, 0402	C2	Taiyo Yuden (USA), Inc.	RM UMK105BJ102KV-F
CAP, 10pF, 5%, 50V, COG, 0402	C3, C4, C13	Murata Electronics	GRM1555C1H100JZ01E
CAP, 100pF, 5%, 50V, COG, 0402	C6	Taiyo Yuden (USA), Inc.	RM UMK105CG101JV-F
CAP, 4.7pF, ±0.1pF, 50V, COG, 0402	C7	Taiyo Yuden (USA), Inc.	RM UMK105CG4R7BW-F
CAP, 3pF, ±0.1pF, 50V, COG, 0402	C8	Taiyo Yuden (USA), Inc.	RM UMK105CG030BW-F
CAP, 3.3pF, ±0.1pF, 50V, COG, 0402	C9	Taiyo Yuden (USA), Inc.	RM UMK105CG3R3BW-F
CAP, 1.5pF, ±0.1pF, 50V, COG, 0402	C11	Taiyo Yuden (USA), Inc.	RM UMK105CG1R5BW-F
CAP, 0.1uF, 10%, 16V, X7R, 0402	C5	Murata Electronics	GRM155R71C104KA88D
CAP, 0.5pF, ±0.1pF, 50V, COG, 0402	C24	Taiyo Yuden (USA), Inc.	RM UMK105CG0R5BW-F
IND, 24nH, 5%, W/W, 0603	L1	Coilcraft	0603HC-24NXJLW
RES, 0Ω, 0402	L2	Kamaya, Inc	RMC1/16SJPTH
CONN, SMA, END, LAUNCH, RND, PIN, 0.062"	J1, J2	GIGALANE CO., LTD.	PAF-S05-008
CONN, HDR, ST, 2-PIN, 0.100	P1, P2	Sullins Electronics	PBC02SAAN
RFPA3809SB	U1	RFMD	RFPA3809
FER, BEAD, 260Ω, 2A, 0603	R1	Murata Electronics	BLM18EG221SN1D
RES, 620Ω, 5%, 1/16W, 0402	R2	PANASONIC INDUSTRIAL CO	ERJ-2GEJ621X
RES, 0Ω, 0603	R4	Kamaya, Inc	RMC1/16JPTP
RES, 2K, 5%, 1/16W, 0402	R5	Kamaya, Inc	RMC1/16S-202JTH
SCREW 2-56X3/16", SOCKET HEAD		McMaster-Carr Supply Co.	92196A076
Heatsink Block 1.16 sq. in.		RFMD	EEF-102059(B)
DNP	C10, C12, C14-C23, C25-C29, R3, R6-R8		

Evaluation Board Assembly Drawing (2110MHz to 2170MHz Application Circuit)

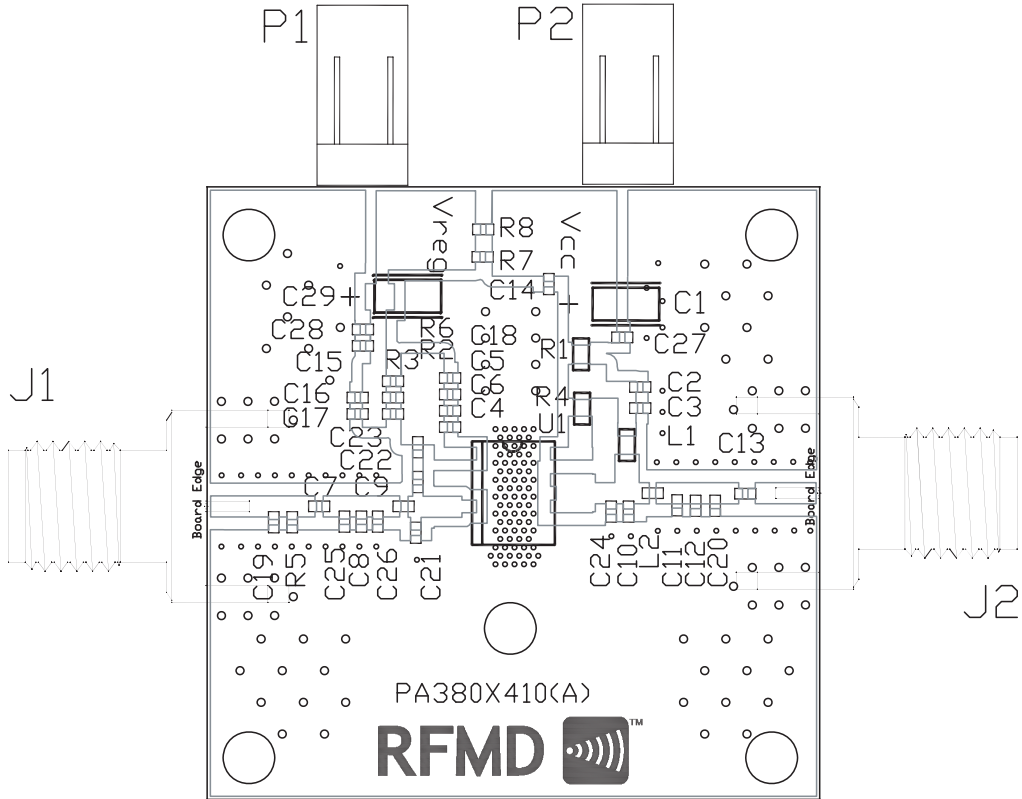

Pin	Function	Description
1	VREF	Control input to the active bias circuit to set I_{OQ} . Can be used as a power-down pin.
2	NC	No connection.
3	RF IN	RF input. External DC block is required.
4	NC	No connection.
5	NC	No connection.
6	RF OUT/VCC	RF output, device collector.
7	RF OUT/VCC	RF output, device collector.
8	VBIAS	Supply voltage for the active bias circuit.
EPAD	GND	DC and RF ground. Must be soldered to EVB ground plane over a bed of vias for thermal and RF performance.

Package Drawing

Dimensions in inches (millimeters)

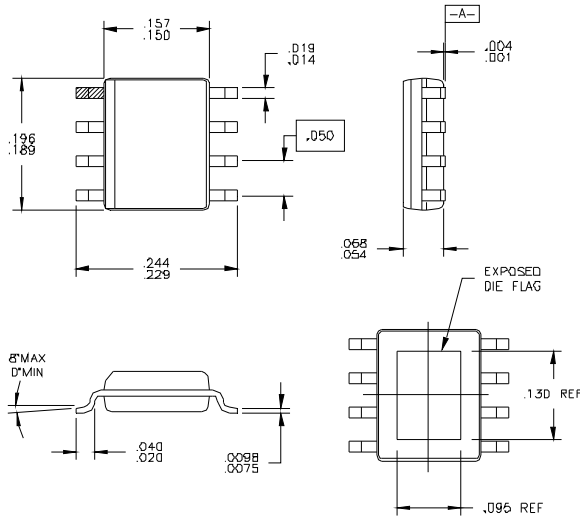

Branding Diagram

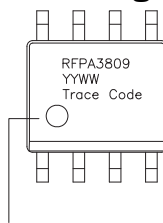

Pin 1 Indicator

Fill in the YYWW Notation with the Date Code

YY = Year

WW = Week

Trace Code to be assigned by SubCon