

product specifications for:

Wiper Motors

Item #: 83082 (Retail)
83182 (OEM)

Description

3000 Waterproof Wiper Motor, 2.5" shaft, 12V, 80°

Motor Specifications

Voltage: 12V
Stall Torque: 159 in-lbs (183 kgf/cm; 18 Nm)
Stall Current: 10.2 - 12.2 Amps

Material Specifications

Body: Aluminum
Gasket(s): Neoprene
Exterior: White Powder Coating
Motor Shaft: Nickel Plated Brass

Standards and Certifications

IEC Ingress Protection Rating: IP66

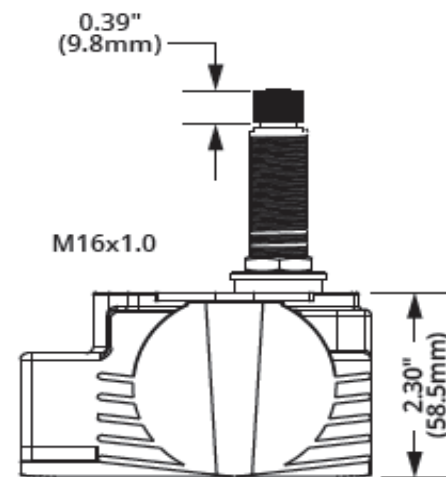
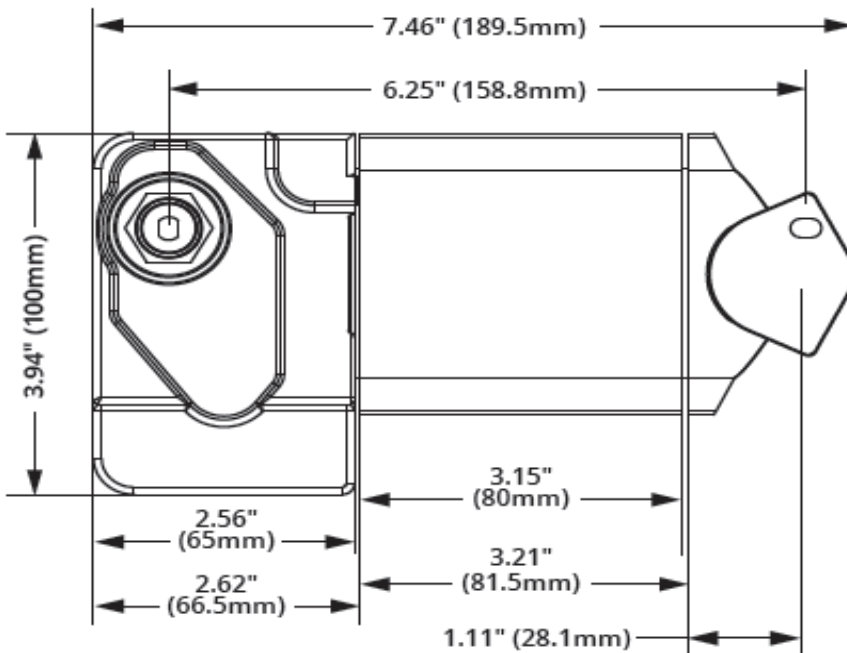

Dimensions: inches [mm]
Drawing not to scale.

toll free 800.307.6702 | marinco.com

MARINCO