

**OMNIMATE basic – Series CH
CH 3.81/02/180F 3.5SN GN BX**

Weidmüller Interface GmbH & Co. KG
Klingenbergstraße 26
D-32758 Detmold
Germany
Fon: +49 5231 14-0
Fax: +49 5231 14-292083
www.weidmueller.com

**General ordering data**

Type	CH 3.81/02/180F 3.5SN GN BX
Order No.	2643230000
GTIN (EAN)	4050118643749
Qty.	624 pc(s).
Product data	IEC: 320 V / 8 A UL: 300 V / 8 A
Packaging	Box

**OMNIMATE basic – Series CH
CH 3.81/02/180F 3.5SN GN BX**

Weidmüller Interface GmbH & Co. KG
Klingenbergstraße 26
D-32758 Detmold
Germany
Fon: +49 5231 14-0
Fax: +49 5231 14-292083
www.weidmueller.com

Technical data
Dimensions and weights

Net weight 1.36 g

System specifications

Product family	OMNIMATE basic – Series CH	Type of connection	Board connection
Mounting onto the PCB	THT solder connection	Pitch in mm (P)	3.81 mm
Pitch in inches (P)	0.15 inch	Outgoing elbow	180°
Number of poles	2	Number of solder pins per pole	1
Solder pin length (l)	3.5 mm	Tolerance of solder pin position	± 0.1 mm
Solder pin dimensions	0.8 x 0.8 mm	Solder eyelet hole diameter (D)	1.3 mm
L1 in mm	3.81 mm	L1 in inches	0.15 inch
Number of rows	1	Pin series quantity	1
Plugging cycles	150		

System Parameters

Product family	OMNIMATE basic – Series CH	Type of connection	Board connection
Pitch in mm (P)	3.81 mm	Pitch in inches (P)	0.15 inch
Number of poles	2	L1 in mm	3.81 mm
L1 in inches	0.15 inch	Number of rows	1
Pin series quantity	1	Plugging cycles	150

Material data

Insulating material	PA GF	Colour	Pale green
Colour chart (similar)	RAL 6021	Insulating material group	I
Insulation strength	500 MΩ	UL 94 flammability rating	V-0
Contact base material	Copper alloy	Contact material	Copper alloy
Contact surface	tinned	Tinning type	matt
Operating temperature, min.	-40 °C	Operating temperature, max.	105 °C

Rated data acc. to IEC

Rated current, min. number of poles (Tu=20°C)	8 A	Rated voltage for surge voltage class / pollution degree II/2	320 V
Rated voltage for surge voltage class / pollution degree III/2	160 V	Rated voltage for surge voltage class / pollution degree III/3	160 V
Rated impulse voltage for surge voltage class/ pollution degree II/2	2.5 kV	Rated impulse voltage for surge voltage class/ pollution degree III/2	2.5 kV
Rated impulse voltage for surge voltage class/ contamination degree III/3	2.5 kV		

Rated data acc. to CSA

Rated voltage (Use group B / CSA)	300 V	Rated current (Use group B / CSA)	8 A
-----------------------------------	-------	-----------------------------------	-----

Data sheet

**OMNIMATE basic – Series CH
CH 3.81/02/180F 3.5SN GN BX**

Weidmüller Interface GmbH & Co. KG
Klingenbergstraße 26
D-32758 Detmold
Germany
Fon: +49 5231 14-0
Fax: +49 5231 14-292083
www.weidmueller.com

Technical data

Rated data acc. to UL 1059

Institute (cURus)		Certificate No. (cURus)	E60693
Rated voltage (Use group B / UL 1059)	300 V	Rated current (Use group B / UL 1059)	8 A
Reference to approval values	Specifications are maximum values, details - see approval certificate.		

Packing

Packaging	Box	VPE length	170 mm
VPE width	130 mm	VPE height	50 mm

Classifications

ETIM 6.0	EC002637	ETIM 7.0	EC002637
eClass 9.0	27-44-04-02	eClass 9.1	27-44-04-02
eClass 10.0	27-44-04-02		

Notes

- Notes
- Only compatible with OMNIMATE basic products
 - P on drawing = pitch
 - Rated current related to rated cross-section & min. No. of poles.
 - Rated data refer only to the component itself. Clearance and creepage distances to other components are to be designed in accordance with the relevant application standards.

Approvals

Approvals	
ROHS	Conform

Data sheet

**OMNIMATE basic – Series CH
CH 3.81/02/180F 3.5SN GN BX**

Weidmüller Interface GmbH & Co. KG
 Klingenbergstraße 26
 D-32758 Detmold
 Germany
 Fon: +49 5231 14-0
 Fax: +49 5231 14-292083
 www.weidmueller.com

Drawings

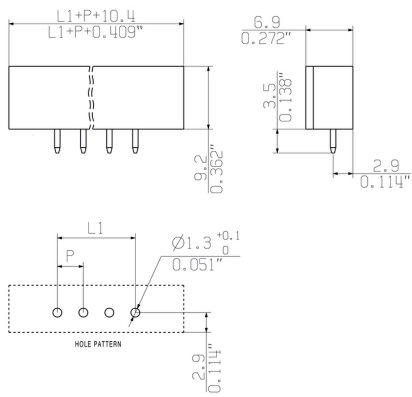

Recommended wave soldering profiles

Weidmüller Interface GmbH & Co. KG
 Klängenbergstraße 16
 D-32758 Detmold
 Germany
 Fon: +49 5231 14-0
 Fax: +49 5231 14-292083
 www.weidmueller.com

Single Wave:



Double Wave:



Wave soldering profiles

Wired connection elements should be processed in accordance with the DIN EN 61760-1 standard. We have included two recommendations for practical wave soldering profiles, with which Weidmüller PCB terminals and connectors are qualified.

When choosing a suitable profile for your application, the following factors also need to be considered:

- PCB thickness
- Proportion of Cu in the layers
- Single/double-sided assembly
- Product range
- Heating and cooling rates

The single and double wave profiles each indicate the recommended operating range, including the maximum soldering temperature of 260°C. In practice, the maximum soldering temperature is quite often well below the above maximum profile.