

Ultra-slim PCB Relays (EMR or SSR) 0.1 - 0.2 - 2 - 6 A



Bottling plant



Packaging machines



Labelling machines



Road / tunnel lighting



Burners, boilers and furnaces



Timers and lighting controls

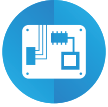

Electronic circuit boards



Programmable controllers

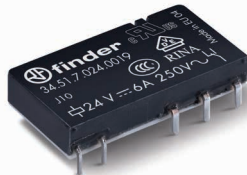
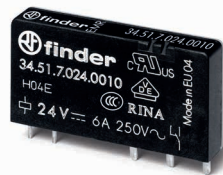

Ultra-slim 1 Pole - 6 A relay

Printed circuit mount

- direct or via PCB socket (according to type)

35 mm rail mount

- via screw, screwless or push-in terminal sockets

- 1 Pole changeover contacts or 1 Pole normally open contact
- Ultra slim (5 mm), package
- Sensitive DC coil - 170 mW (Dual AC/DC coil drive possible using 93 series sockets)
- UL Listing (certain relay/socket combinations)
- Cadmium Free contact materials
- 8/8 mm clearance/creepage distance
- 6 kV (1.2/50 μs) insulation, coil-contacts

FOR UL RATINGS SEE:

"General technical information" page V

For outline drawing see page 9

Contact specification

Contact configuration

Rated current/
Maximum peak current

Rated voltage/
Maximum switching voltage

Rated load AC1

Rated load AC15 (230 V AC)

Single phase motor rating (230 V AC)

Breaking capacity DC1: 24/110/220 V

Minimum switching load

Standard contact material

Coil specification

Nominal voltage (U_N)

V AC (50/60 Hz)

V DC

Rated power AC/DC

VA (50 Hz)/W

Operating range

AC

DC

Holding voltage

AC/DC

Must drop-out voltage

AC/DC

Technical data

Mechanical life AC/DC

cycles

Electrical life at rated load AC1

cycles

Operate/release time

ms

Insulation between coil
and contacts (1.2/50 μs)

kV

Dielectric strength
between open contacts

V AC

Ambient temperature range

°C

Environmental protection

Approvals (according to type)

34.51-xx10

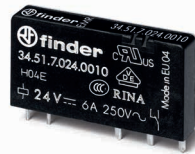

- 5 mm wide
- Low coil power
- PCB or 93 series sockets
- Contact AgNi

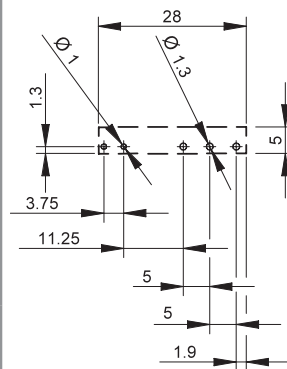
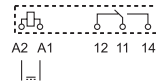

Copper side view

34.51-5x10



- 5 mm wide
- Low coil power
- PCB or 93 series sockets
- Contact AgNi + Au

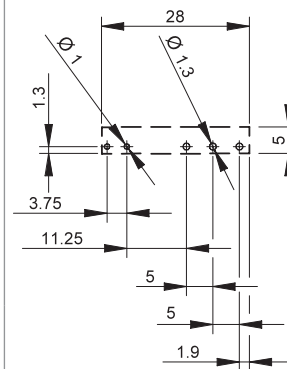
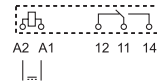

Copper side view

34.51-0000



- 5 mm wide
- Low coil power
- PCB only
- Contact AgSnO₂

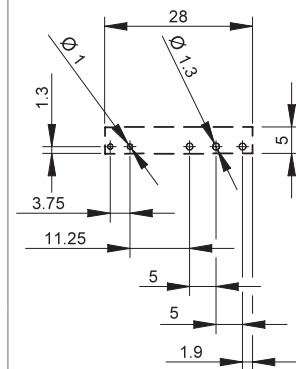
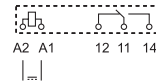

Copper side view

Ultra-slim Solid State Relays

Printed circuit mount

- direct or via PCB socket

35 mm rail mount

- via screw, screwless or push-in terminal sockets

- Single circuit output switching options
 - 6 A, 24 V DC
 - 2 A, 240 V AC
- Silent, high speed switching with long electrical life
- Ultra slim (5 mm), package
- Sensitive DC Input circuits (Dual AC/DC input drive possible using 93 series sockets)
- UL Listing (certain relay/socket combinations)
- Wash tight: RT III
- 3000 V AC insulation, input-output

NEW 34.81.7.xxx.9024



- 6 A, 24 V DC output switching
- PCB or 93 series sockets

34.81.7.xxx.8240



- 2 A, 240 V AC output switching
- Zero crossing switching
- PCB or 93 series sockets

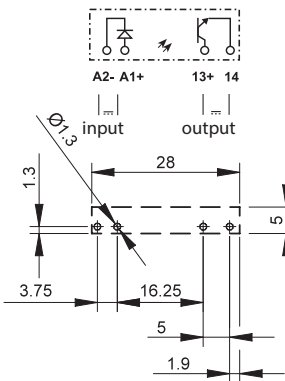

Copper side view

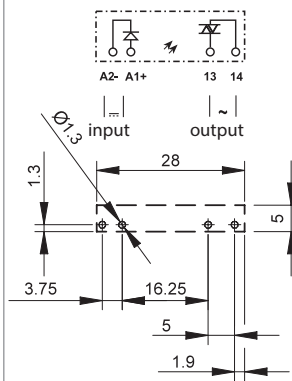

Copper side view

For outline drawing see page 9

Output circuit

| | | | |
|--|-----------------|----------------|-------------------|
| Contact configuration | | 1 NO (SPST-NO) | 1 NO (SPST-NO) |
| Rated current/ Maximum peak current (10 ms) | A | 6/50 | 2/80 |
| Rated switching voltage | V | 24 DC | 240 AC (50/60 Hz) |
| Switching voltage range | V | (1.5...33)DC | (12...275)AC |
| Maximum blocking voltage | V | 33 | — |
| Repetitive peak off-state voltage | V _{pk} | — | 800 |
| Rated load DC13 | W | 36 | — |
| Rated load AC15 | VA | — | 300 |
| Minimum switching current | mA | 1 | 35 |
| Max. "OFF-state" leakage current | mA | 0.001 | 1.5 |
| Max. "ON-state" voltage drop | V | 0.4 | 1.6 |

Supply specification

| | | | | | | | | | |
|-----------------------------------|------|---------|--------|---------|---------|---------|--------|---------|---------|
| Nominal voltage (U _N) | V DC | 5 | 12 | 24 | 60 | 5 | 12 | 24 | 60 |
| Rated power | W | 0.035 | 0.085 | 0.17 | 0.21 | 0.06 | 0.085 | 0.17 | 0.21 |
| Operating range | V DC | 35...12 | 8...17 | 16...30 | 35...72 | 35...10 | 8...17 | 16...30 | 35...72 |
| Control current | mA | 7 | 7 | 7 | 3.5 | 12 | 7 | 7 | 3.5 |
| Release voltage | V DC | 4 | 4 | 10 | 20 | 1 | 4 | 10 | 20 |

Technical data

| | | | | | | | | | |
|--|--------|-------------------|--|--|--|-------------------|--|--|--|
| Electrical life at rated load | cycles | > 10 ⁶ | | | | > 10 ⁶ | | | |
| Operate/release time | ms | 0.02/0.2 | | | | 11/11 | | | |
| Insulation between input and output (1.2/50μs) | kV | 4 | | | | 4 | | | |
| Ambient temperature range | °C | -20...+70* | | | | -20...+50* | | | |
| Environmental protection | | RT III | | | | RT III | | | |

Approvals (according to type)



* Note: all technical data relates to using the relay directly on PCB or PCB socket type 93.11.
If the relay is used with 35 mm rail socket types 93.01 and 93.51, refer to the technical data of 38 Series; if used with types 93.60, 93.61, 93.62, 93.63, 93.64, 93.65, 93.66, 93.67, 93.68 and 93.69, refer to the technical data of the **MasterINTERFACE** 39 Series. See L34 diagrams page 8

Ultra-slim Solid State Relays

- Printed circuit mount**
- direct or via PCB socket
35 mm rail mount
- via screw, screwless or push-in terminal sockets

- Single circuit output switching options
- 0.1 A, 48 V DC
- 0.2 A, 220 V DC
- Silent, high speed switching with long electrical life
- Ultra slim (5 mm), package
- Sensitive DC Input circuits (Dual AC/DC input drive possible using 93 series sockets)
- UL Listing (certain relay/socket combinations)
- Wash tight: RT III
- 3000 V AC insulation, input-output

34.81.7.xxx.7048

NEW 34.81.7.xxx.7220



- 100 mA, 48 V DC output switching
- PCB or 93 series sockets

- 200 mA, 110/220 V DC output switching
- PCB or 93 series sockets

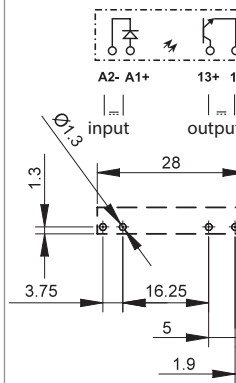
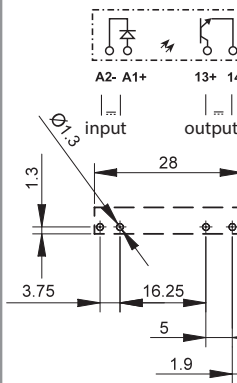

Copper side view

Copper side view

For outline drawing see page 9

Output circuit

| | | | | | |
|--|----|----------------|--|----------------|--|
| Contact configuration | | 1 NO (SPST-NO) | | 1 NO (SPST-NO) | |
| Rated current/ Maximum peak current (10 ms) | A | 0.1/0.5 | | 0.2/10 | |
| Rated switching voltage | V | 48 DC | | 220 DC | |
| Switching voltage range | V | (1.5...53)DC | | (90...256)DC | |
| Maximum blocking voltage | V | 53 | | 256 | |
| Rated load DC13 | W | 2.4 | | 44 | |
| Minimum switching current | mA | 0.05 | | 0.05 | |
| Max. "OFF-state" leakage current | mA | 0.001 | | 0.001 | |
| Max. "ON-state" voltage drop | V | 1 | | 0.4 | |

Supply specification

| | | | | | |
|-----------------------------------|------|---------|---------|---------|---------|
| Nominal voltage (U _N) | V DC | 24 | 60 | 24 | 60 |
| Rated power | W | 0.17 | 0.21 | 0.17 | 0.21 |
| Operating range | V DC | 16...30 | 35...72 | 16...30 | 35...72 |
| Control current | mA | 7 | 3.5 | 7 | 3.5 |
| Release voltage | V DC | 10 | 20 | 10 | 20 |

Technical data

| | | | | | |
|--|--------|-------------------|--|-------------------|--|
| Electrical life at rated load | cycles | > 10 ⁶ | | > 10 ⁶ | |
| Operate/release time | ms | 0.03/0.6 | | 0.4/2.2 | |
| Insulation between input and output (1.2/50μs) | kV | 4 | | 4 | |
| Ambient temperature range | °C | -20...+70* | | -20...+70* | |
| Environmental protection | | RT III | | RT III | |

Approvals (according to type)



* Note: all technical data relates to using the relay directly on PCB or PCB socket type 93.11.
If the relay is used with 35 mm rail socket types 93.01 and 93.51, refer to the technical data of 38 Series; if used with types 93.60, 93.61, 93.62, 93.63, 93.64, 93.65, 93.66, 93.67, 93.68 and 93.69, refer to the technical data of the MasterINTERFACE 39 Series.

Ordering information

Electromechanical relay (EMR)

Example: 34 series Ultra-Slim electromechanical relay, 1 CO (SPDT) 6 A contacts, 24 V sensitive DC coil.

A

3 4 . 5 1 . 7 . 0 2 4 . 0 0 1 0

Series ————

Type ————
5 = Electromechanical type

No. of poles ————
1 = 1 pole, 6 A

Coil version ————
7 = Sensitive DC

Coil voltage ————
See coil specifications

A: Contact material
0 = Standard AgNi,
Standard AgSnO₂
(for 34.51-0000 only)
4 = AgSnO₂
5 = AgNi + Au

B: Contact circuit
0 = CO (SPDT)
3 = NO (SPST)

C: Options
0 = Wash tight RT III
1 = Flux proof RT II

D: Special versions
0 = Standard version
9 = Flat version

Selecting features and options: only combinations in the same row are possible.

Preferred selections for best availability are shown in **bold**.

| Type | Coil version | A | B | C | D |
|-------|--------------|------------------|--------------|--------------|----------|
| 34.51 | sens. DC | 0 - 4 - 5 | 0 - 3 | 0 - 1 | 0 |
| 34.51 | sens. DC | 0 - 4 - 5 | 0 | 1 | 9 |

Solid state relay (SSR)

Example: 34 series solid state relay, 6 A 24 V DC output, 24 V DC supply.

3 4 . 8 1 . 7 . 0 2 4 . 9 0 2 4

Series ————

Type ————
8 = SSR type

Output ————
1 = 1 NO (SPST-NO)

Input circuit ————
See input specifications

Output circuit
9024 = 6 A - 24 V DC
7048 = 0.1 A - 48 V DC
7220 = 0.2 A - 220 V DC
8240 = 2 A - 240 V AC

Flat pack version



Option = 34.51.7xxx.x019

Environmental protection RT I

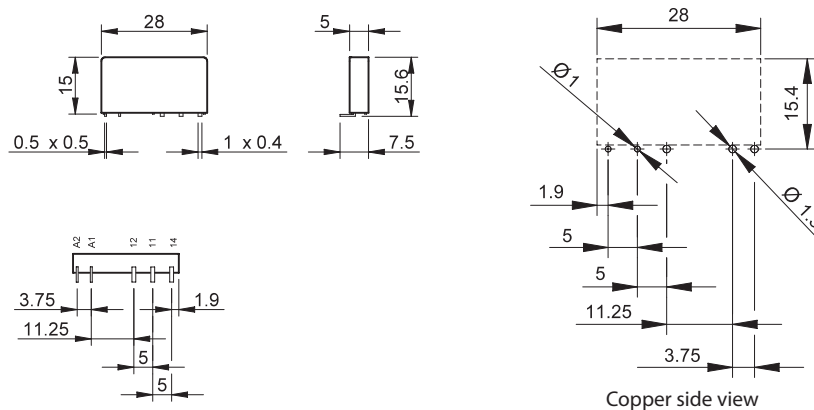

Electromechanical relay

A

Technical data

| Insulation according to EN 61810-1 | | | |
|---|--------------------------|---------------------|-----|
| Nominal voltage of supply system | V AC | 230/400 | |
| Rated insulation voltage | V AC | 250 | 400 |
| Pollution degree | | 3 | 2 |
| Insulation between coil and contact set | | | |
| Type of insulation | | Reinforced | |
| Overtoltage category | | III | |
| Rated impulse voltage | kV (1.2/50 μ s) | 6 | |
| Dielectric strength | V AC | 4000 | |
| Insulation between open contacts | | | |
| Type of disconnection | | Micro-disconnection | |
| Dielectric strength | V AC/kV (1.2/50 μ s) | 1000/1.5 | |
| Insulation between coil terminals | | | |
| Rated impulse voltage (surge) differential mode (according to EN 61000-4-5) | kV (1.2/50 μ s) | 2 | |
| Other data | | | |
| Bounce time: NO/NC | ms | 1/6 | |
| Vibration resistance (5...55)Hz: NO/NC | g | 10/5 | |
| Shock resistance | g | 20/14 | |
| Power lost to the environment | without contact current | W | 0.2 |
| | with rated current | W | 0.5 |
| Recommended distance between relays mounted on PCB | mm | ≥ 5 | |

Contact specification

F 34 - Electrical life (AC) v contact current

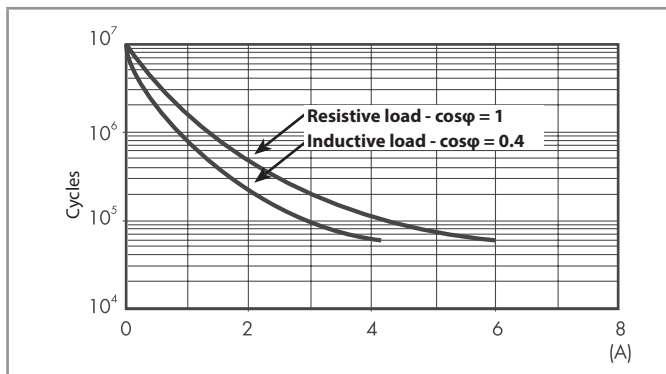

H 34 - Maximum DC1 breaking capacity

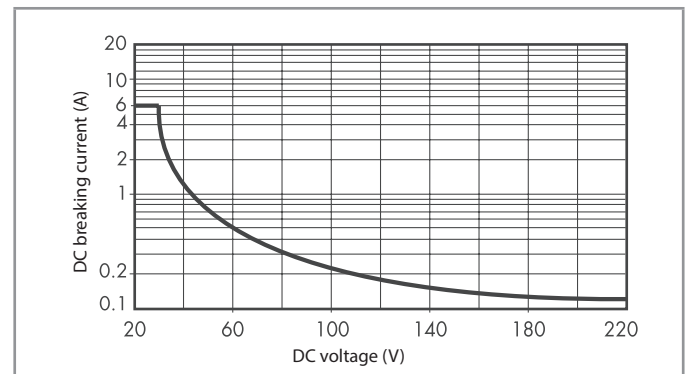

- When switching a resistive load (DC1) having voltage and current values under the curve, an electrical life of $\geq 60 \cdot 10^3$ can be expected.
- In the case of DC13 loads, the connection of a diode in parallel with the load will permit a similar electrical life as for a DC1 load.
Note: the release time for the load will be increased.

Coil specifications

DC coil data

| Nominal voltage | Coil code | Operating range | | Resistance | Rated coil consumption |
|-----------------|-----------|-----------------|-----------|------------|------------------------|
| | | U_{min} | U_{max} | | |
| V | | V | V | Ω | mA |
| 5 | 7.005 | 3.5 | 7.5 | 130 | 38.4 |
| 12 | 7.012 | 8.4 | 18 | 840 | 14.2 |
| 24 | 7.024 | 16.8 | 36 | 3350 | 7.1 |
| 48 | 7.048 | 33.6 | 72 | 12300 | 3.9 |
| 60 | 7.060 | 42 | 90 | 19700 | 3 |

R 34 - DC coil operating range v ambient temperature

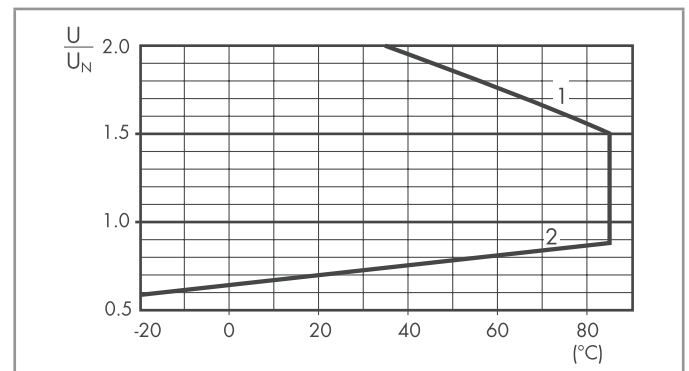

- 1 - Max. permitted coil voltage.
- 2 - Min. pick-up voltage with coil at ambient temperature.

Solid state relay

Technical data

A

| | | | |
|--|------------------------|----------------------------|----------------------------|
| Insulation | | Dielectric strength | Impulse (1.2/50 µs) |
| Between input and output | | 3000 V AC | 4 kV |
| EMC specifications | | Reference standard | |
| Electrostatic discharge | contact discharge | EN 61000-4-2 | 4 kV |
| | air discharge | EN 61000-4-2 | 8 kV |
| Radiated electromagnetic field (80...1000 MHz) | | EN 61000-4-3 | 10 V/m |
| Fast transients on supply terminals (burst 5/50 ns, 5 and 100 kHz) | | EN 61000-4-4 | 2 kV |
| Voltage pulses on supply terminals (surge 1.2/50 µs) | common mode | EN 61000-4-5 | 0.7 kV |
| | differential mode | EN 61000-4-5 | 0.7 kV* |
| Radio-frequency common mode voltage (0.15...230 MHz) | | EN 61000-4-6 | 10 V |
| Other data | | | |
| Power lost to the environment | without output current | W | 0.15 |
| | with rated current | W | 0.4 |

* For 34.81.7.005... = 0.3 kV; for 34.81.7.012... = 0.5 kV

Input specification

Input data - DC types

| Nominal voltage U_N V | Input code | Operating range | | Release voltage V | Impedance Ω | Control current I at U_N mA |
|-------------------------------|------------|-----------------|----------------|----------------------|-----------------------|-------------------------------------|
| | | U_{min} V | U_{max} V | | | |
| 5 | 7.005 | 3.5 | 12* | 1 | 715 | 7* |
| 12 | 7.012 | 8 | 17 | 4 | 1715 | 7 |
| 24 | 7.024 | 16 | 30 | 10 | 3430 | 7 |
| 60 | 7.060 | 35 | 72 | 20 | 17000 | 3.5 |

* For 34.81.7.005.8240: $U_{MAX} = 10 V$, $I @ 5 V = 12 mA$

Output specification

L 34-1 - Output DC current v ambient temperature

34.81.7...9024

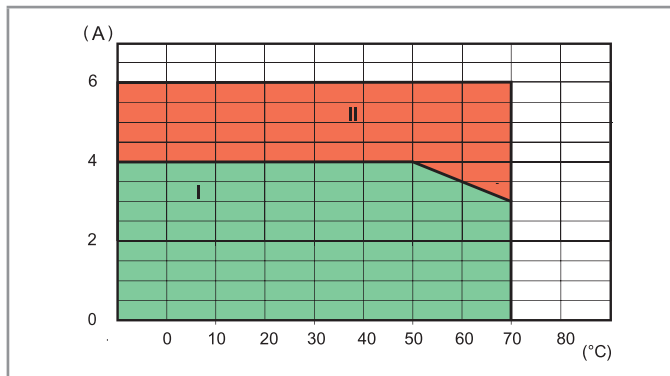

L 34 - Output AC current v ambient temperature

34.81.7...8240

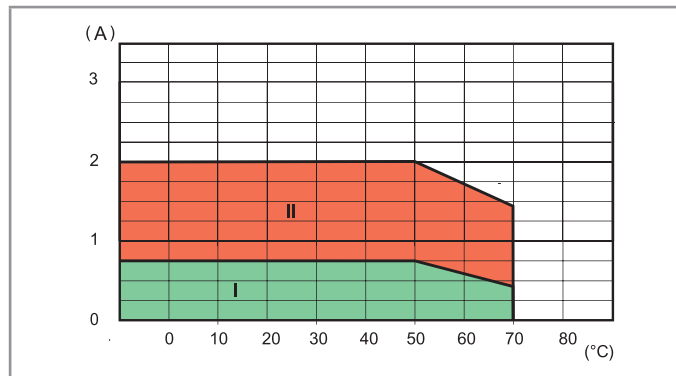

I: SSR installed on 93 series sockets as a group (without gap between sockets)

II: SSR installed individually in free air, or with a gap $\geq 9 mm$, which implies a not significant influence from nearby components

Max recommended switching frequency (Cycles/Hour, with 50% Duty-cycle) at ambient temperature 50°C, single mounting

| Load | 34.81.7xxx.9024 | 34.81.7xxx.8240 | 34.81.7xxx.7048 | 34.81.7xxx.7220 |
|---------------------------|-----------------|-----------------|-----------------|-----------------|
| 24 V 6 A DC1 | 180 000 | — | — | — |
| 24 V 3 A DC L/R = 10 ms | 5000 | — | — | — |
| 24 V 2 A DC L/R = 40 ms | 3600 | — | — | — |
| 24 V 1 A DC L/R = 40 ms | 6500 | — | — | — |
| 24 V 0.8 A DC L/R = 40 ms | 9000 | — | — | — |
| 24 V 1.5 A DC L/R = 80 ms | 3250 | — | — | — |
| 230 V 2 A AC1 | — | 60 000 | — | — |
| 230 V 1.25 A AC15 | — | 3600 | — | — |
| 48 V 0.1 A DC1 | — | — | 60 000 | — |
| 220 V 0.2 A DC1 | — | — | — | 60 000 |

Outline drawings

Type 34.51

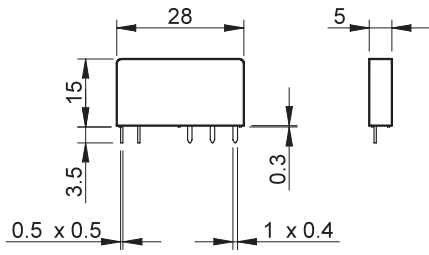

Type 34.81

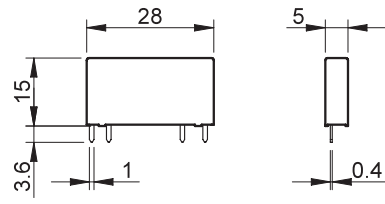

A

A

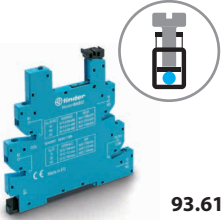

93.61

Screw terminal socket 35 mm rail mounting (EN 60715)

Common features

- Space saving 6.2 mm wide
- Connections for 16-way jumper link
- Integral coil indication and protection circuit
- Secure retention and easy ejection by plastic clip
- Dual screw head (blade+cross) terminals

For technical data and supply versions, refer to the Master **INTERFACE 39 Series** – “Relay interface module”

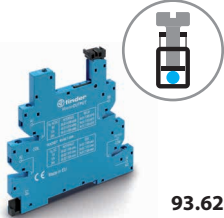

93.62

Electromechanical Relay - EMR

| Supply voltage | Relay type | Socket type (reference with the 39 Series) | | | | |
|---------------------|------------------|--|----------------------------------|-----------------------------------|------------------------------------|-----------------------------------|
| | | Master BASIC (39.11...) | Master PLUS (39.31...) | Master INPUT (39.41...) | Master OUTPUT (39.21...) | Master TIMER (39.81...) |
| 6 V AC/DC | 34.51.7.005.xx10 | 93.61.7.024 | 93.63.7.024 | 93.64.7.024 | 93.62.7.024 | — |
| 12 V AC/DC | 34.51.7.012.xx10 | 93.61.7.024 | 93.63.7.024 | 93.64.7.024 | 93.62.7.024 | 93.68.0.024 |
| 24 V AC/DC | 34.51.7.024.xx10 | 93.61.7.024 | 93.63.7.024 | 93.64.7.024 | 93.62.7.024 | 93.68.0.024 |
| 60 V AC/DC | 34.51.7.060.xx10 | — | 93.63.7.060 | — | — | — |
| (110...125)V AC/DC* | 34.51.7.060.xx10 | — | 93.63.3.125 | — | — | — |
| (220...240)V AC* | 34.51.7.060.xx10 | — | 93.63.3.230 | — | — | — |
| (110...125)V AC/DC | 34.51.7.060.xx10 | 93.61.0.125 | 93.63.0.125 | 93.64.0.125 | 93.62.0.125 | — |
| (24...240)V AC/DC | 34.51.7.024.xx10 | — | 93.63.0.240 | — | — | — |
| (220...240)V AC | 34.51.7.060.xx10 | 93.61.8.230 | 93.63.8.230 | 93.64.8.230 | 93.62.8.230 | — |
| (110...125)V DC | 34.51.7.060.xx10 | — | 93.63.7.125 | — | — | — |
| 220 V DC | 34.51.7.060.xx10 | — | 93.63.7.220 | — | — | — |

* Leakage current suppression

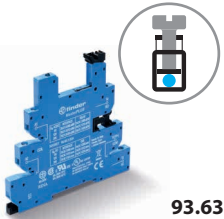

93.63

Solid State Relay - SSR

| Supply voltage | Relay type | Socket type (reference with the 39 Series) | | | | |
|---------------------|------------------|--|----------------------------------|-----------------------------------|------------------------------------|-----------------------------------|
| | | Master BASIC (39.10...) | Master PLUS (39.30...) | Master INPUT (39.40...) | Master OUTPUT (39.20...) | Master TIMER (39.80...) |
| 12 V AC/DC | 34.81.7.012.xxxx | — | — | — | — | 93.68.0.024 |
| 24 V AC/DC | 34.81.7.024.xxxx | — | 93.63.0.024 | 93.64.0.024 | — | 93.68.0.024 |
| (110...125)V AC/DC* | 34.81.7.060.xxxx | — | 93.63.3.125 | — | — | — |
| (220...240)V AC* | 34.81.7.060.xxxx | — | 93.63.3.230 | — | — | — |
| (110...125)V AC/DC | 34.81.7.060.xxxx | 93.61.0.125 | 93.63.0.125 | 93.64.0.125 | 93.62.0.125 | — |
| (24...240)V AC/DC | 34.81.7.024.xxxx | — | 93.63.0.240 | — | — | — |
| (220...240)V AC | 34.81.7.060.xxxx | 93.61.8.230 | 93.63.8.230 | 93.64.8.230 | 93.62.8.230 | — |
| 6 V DC | 34.81.7.005.xxxx | 93.61.7.024 | 93.63.7.024 | 93.64.7.024 | 93.62.7.024 | — |
| 12 V DC | 34.81.7.012.xxxx | 93.61.7.024 | 93.63.7.024 | 93.64.7.024 | 93.62.7.024 | — |
| 24 V DC | 34.81.7.024.xxxx | 93.61.7.024 | 93.63.7.024 | 93.64.7.024 | 93.62.7.024 | — |
| 60 V DC | 34.81.7.060.xxxx | — | 93.63.7.060 | — | — | — |
| (110...125)V DC | 34.81.7.060.xxxx | — | 93.63.7.125 | — | — | — |
| 220 V DC | 34.81.7.060.xxxx | — | 93.63.7.220 | — | — | — |

* Leakage current suppression



93.64

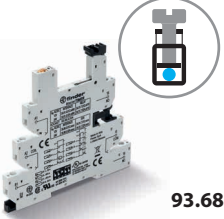

93.68

Approvals
(according to type):



Accessories

| | |
|--------------------------------|---|
| 16-way jumper link | 093.16 (blue), 093.16.0 (black), 093.16.1 (red) |
| Dual-purpose plastic separator | 093.60 |
| Sheet of marker tags | 060.48 and 093.48 |

Technical data

| | |
|---------------------|--|
| Rated values | 6 A - 250 V |
| Dielectric strength | 6 kV (1.2/50 μs) between coil and contacts |
| Protection category | IP 20 |
| Ambient temperature | °C -40...+70 |
| Screw torque | Nm 0.5 |
| Wire strip length | mm 10 |
| Max wire size | Solid wire and stranded wire |
| | mm ² 1 x (0.5...2.5) / 2 x 1.5 |
| | AWG 1 x (21...14) / 2 x 16 |



Push-In terminal socket 35 mm rail mounting (EN 60715)

Common features

- Space saving 6.2 mm wide
- Connections for 16-way jumper link
- Terminal doubler 093.62
- Integral coil indication and protection circuit
- Secure retention and easy ejection by plastic clip



93.60

For technical data and supply versions, refer to the Master**INTERFACE 39 Series** – “Relay interface module”



Electromechanical Relay - EMR

| Supply voltage | Relay type | Socket type (reference with the 39 Series) | | | | |
|---------------------|------------------|--|----------------------------------|-----------------------------------|------------------------------------|-----------------------------------|
| | | Master BASIC (39.01...) | Master PLUS (39.61...) | Master INPUT (39.71...) | Master OUTPUT (39.51...) | Master TIMER (39.91...) |
| 6 V AC/DC | 34.51.7.005.xx10 | 93.60.7.024 | 93.66.7.024 | 93.67.7.024 | 93.65.7.024 | — |
| 12 V AC/DC | 34.51.7.012.xx10 | 93.60.7.024 | 93.66.7.024 | 93.67.7.024 | 93.65.7.024 | 93.69.0.024 |
| 24 V AC/DC | 34.51.7.024.xx10 | 93.60.7.024 | 93.66.7.024 | 93.67.7.024 | 93.65.7.024 | 93.69.0.024 |
| 60 V AC/DC | 34.51.7.060.xx10 | — | 93.66.7.060 | — | — | — |
| (110...125)V AC/DC* | 34.51.7.060.xx10 | — | 93.66.3.125 | — | — | — |
| (220...240)V AC* | 34.51.7.060.xx10 | — | 93.66.3.230 | — | — | — |
| (110...125)V AC/DC | 34.51.7.060.xx10 | 93.60.0.125 | 93.66.0.125 | 93.67.0.125 | 93.65.0.125 | — |
| (24...240)V AC/DC | 34.51.7.024.xx10 | — | 93.66.0.240 | — | — | — |
| (220...240)V AC | 34.51.7.060.xx10 | 93.60.8.230 | 93.66.8.230 | 93.67.8.230 | 93.65.8.230 | — |
| (110...125)V DC | 34.51.7.060.xx10 | — | 93.66.7.125 | — | — | — |
| 220 V DC | 34.51.7.060.xx10 | — | 93.66.7.220 | — | — | — |

* Leakage current suppression



93.66



Solid State Relay - SSR

| Supply voltage | Relay type | Socket type (reference with the 39 Series) | | | | |
|---------------------|------------------|--|----------------------------------|-----------------------------------|------------------------------------|-----------------------------------|
| | | Master BASIC (39.00...) | Master PLUS (39.60...) | Master INPUT (39.70...) | Master OUTPUT (39.50...) | Master TIMER (39.90...) |
| 12 V AC/DC | 34.81.7.012.xxxx | — | — | — | — | 93.69.0.024 |
| 24 V AC/DC | 34.81.7.024.xxxx | — | 93.66.0.024 | 93.67.0.024 | — | 93.69.0.024 |
| (110...125)V AC/DC* | 34.81.7.060.xxxx | — | 93.66.3.125 | — | — | — |
| (220...240)V AC* | 34.81.7.060.xxxx | — | 93.66.3.230 | — | — | — |
| (110...125)V AC/DC | 34.81.7.060.xxxx | 93.60.0.125 | 93.66.0.125 | 93.67.0.125 | 93.65.0.125 | — |
| (24...240)V AC/DC | 34.81.7.024.xxxx | — | 93.66.0.240 | — | — | — |
| (220...240)V AC | 34.81.7.060.xxxx | 93.60.8.230 | 93.66.8.230 | 93.67.8.230 | 93.65.8.230 | — |
| 6 V DC | 34.81.7.005.xxxx | 93.60.7.024 | 93.66.7.024 | 93.67.7.024 | 93.65.7.024 | — |
| 12 V DC | 34.81.7.012.xxxx | 93.60.7.024 | 93.66.7.024 | 93.67.7.024 | 93.65.7.024 | — |
| 24 V DC | 34.81.7.024.xxxx | 93.60.7.024 | 93.66.7.024 | 93.67.7.024 | 93.65.7.024 | — |
| 60 V DC | 34.81.7.060.xxxx | — | 93.66.7.060 | — | — | — |
| (110...125)V DC | 34.81.7.060.xxxx | — | 93.66.7.125 | — | — | — |
| 220 V DC | 34.81.7.060.xxxx | — | 93.66.7.220 | — | — | — |

* Leakage current suppression



93.67



93.69

Approvals
(according to type):



Accessories

| | |
|--------------------------------|---|
| 16-way jumper link | 093.16 (blue), 093.16.0 (black), 093.16.1 (red) |
| Dual-purpose plastic separator | 093.60 |
| Terminal doubler | 093.62 |
| Sheet of marker tags | 060.48 and 093.48 |

Technical data

| | |
|---------------------|--|
| Rated values | 6 A - 250 V |
| Dielectric strength | 6 kV (1.2/50 μs) between coil and contacts |
| Protection category | IP 20 |
| Ambient temperature | °C -40...+70 |
| Wire strip length | mm 8 |
| Max wire size | Solid wire and stranded wire |
| | mm ² 1 x (0.5...2.5) |
| | AWG 1 x (21...14) |

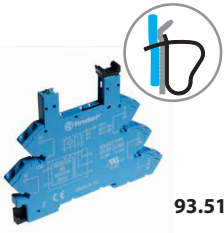

93.51

Screw less terminal socket 35 mm rail mounting (EN 60715)**Common features**

- Space saving 6.2 mm wide
- Connections for 20-way jumper link
- Integral coil indication and protection circuit
- Secure retention and easy ejection by plastic clip

For technical data and supply versions, refer to the **38 Series** – “Relay interface module”Approvals
(according to type):RINA cRU[®] US
 Certain relay/socket combinations
Electromechanical Relay - EMR and Solid State Relay - SSR

| Supply voltage | Relay type (reference with the 38 Series) | | Socket type |
|---------------------|---|---------------------------------------|-------------|
| | Electromechanical relay - EMR (38.61...) | Solid State Relay - SSR (38.81...) | |
| 12 V AC/DC | 34.51.7.012.xx10 | — | 93.51.0.024 |
| 24 V AC/DC | 34.51.7.024.xx10 | — | 93.51.0.024 |
| (110...125)V AC/DC | 34.51.7.060.xx10 | 34.81.7.060.xxxx | 93.51.0.125 |
| (220...240)V AC/DC | 34.51.7.060.xx10 | 34.81.7.060.xxxx | 93.51.0.240 |
| (110...125)V AC/DC* | 34.51.7.060.xx10 | 34.81.7.060.xxxx | 93.51.3.125 |
| (220...240)V AC* | 34.51.7.060.xx10 | 34.81.7.060.xxxx | 93.51.3.240 |
| (220...240)V AC | 34.51.7.060.xx10 | 34.81.7.060.xxxx | 93.51.8.240 |
| 12 V DC | 34.51.7.012.xx10 | 34.81.7.012.xxxx | 93.51.7.024 |
| 24 V DC | 34.51.7.024.xx10 | 34.81.7.024.xxxx | 93.51.7.024 |
| 60 V DC | 34.51.7.060.xx10 | 34.81.7.060.xxxx | 93.51.7.060 |

* Leakage current suppression

Accessories

| | |
|----------------------|--------|
| 20-way jumper link | 093.20 |
| Plastic separator | 093.01 |
| Sheet of marker tags | 093.48 |

Technical data

| | |
|---|--|
| Rated values | 6 A - 250 V |
| Dielectric strength | 6 kV (1.2/50 μs) between coil and contacts |
| Protection category | IP 20 |
| Ambient temperature ($U_N \leq 60$ V / > 60 V) | °C -40...+70 / -40...+55 |
| Wire strip length | mm 10 |
| Max wire size | Solid wire and stranded wire |
| | mm ² 1 x 2.5 / 2 x 1.5 |
| | AWG 1 x 14 / 2 x 16 |



93.11

Approvals
(according to type):



| | |
|---|--|
| PCB socket with retaining and release clip | 93.11 (blue) |
| For relay type | 34.51, 34.81 |
| Technical data | |
| Rated values | 6 A - 250 V |
| Dielectric strength | ≥ 6 kV (1.2/50 μs) between coil and contacts |
| Protection category | IP 20 |
| Ambient temperature | °C -40...+70 |

A

Retaining and release clip use:

