

GlobTek, Inc. www.globtek.com 186 Veterans Drive, Northvale, NJ 07647 Tel. (201) 784-1000 Fax (201) 784-0111	Drawing Title: GT-86181-1810 -W2, ICT/ITE Power Supply, Efficiency Level: USA DOE Level VI / Eco-design Directive 2009/125/EC, (EU) 2019/1782, Case Color/Style: GlobTek Black, Wall Plug-in, Regulated Switchmode AC-DC Power Supply AC Adaptor, Input Rating: 100-240V- , 50/60Hz, N. America NEMA 1-15 Fixed, , Output Rating: 18.00W, 10.0V@1.8A, Pin Out: Center Positive (+V), symbol compliant with IEC 60417 symbol no. 5926, Output Configuration: 1500 mm, 20/2 Cond, UL 2468, Female Barrel 5.5*2.1*11mm w/ Spring Clip & Locking Notch or Equal, Ferrite: None, GlobTek Black, GT Cord # C5034, Blades/Input Cord: (Order Separately), Approvals:	
	Model No. GT-86181-1810 -W2	
	Part No./Ordering No. WR9HU1800CCP-F(R6B)	Rev A

In Addition to GlobTek Inc.'s renewed ISO9001:2015 - Quality Management System Certification, GlobTek Inc. is now certified to:

ISO13485:2016 - Medical Devices Quality Management System Certification

ISO14001:2015 - Environmental Management System Certification

ISO Certificates are available online at <https://www.globtek.com/iso-certificates/>

The acceptance of this specification and use of the product described in this document indicates the acceptance and binding of the customer to Globtek TERMS AND CONDITIONS (attached to the end of this document), which supersede all other agreements, terms, and conditions (<https://www.globtek.com/terms-and-conditions/>).

The purchaser of this product (Customer) agrees that it is their sole responsibility to determine suitability/fitness of the product described in this specification for their application and to take precautions for protection against any hazards attendant to the handling and use of the product.

Footnote:

GlobTek Inc. will not be liable for the safety and performance of these power supplies/battery packs if unauthorized access and repair occurs. End user should consult applicable UL, CSA or EN standards for proper installation instruction.

Limitation of Use:

GlobTek products are intended for use with commercial, medical, and/or industrial equipment only. GlobTek product are not authorized for use as mission critical components in life support hazardous environment, nuclear or aircraft applications without prior written approval from the CEO of GlobTek Inc.

Contents of this document are subject to change without prior notice.

Customer Approval of Specification:

Please approve, sign and send back to GlobTek so we can complete order processing.

A delay in receipt of this form will delay delivery schedule.

Company Name: _____	Customer P/N: _____
Quote Number: _____	Date: _____
Authorized Representative Name: _____	Authorized Representative Signature: _____

GlobTek, Inc. www.globtek.com 186 Veterans Drive, Northvale, NJ 07647 Tel. (201) 784-1000 Fax (201) 784-0111	Drawing Title: GT-86181-1810 -W2, ICT/ITE Power Supply, Efficiency Level: USA DOE Level VI / Eco-design Directive 2009/125/EC, (EU) 2019/1782, Case Color/Style: GlobTek Black, Wall Plug-in, Regulated Switchmode AC-DC Power Supply AC Adaptor, Input Rating: 100-240V- , 50/60Hz, N. America NEMA 1-15 Fixed, , Output Rating: 18.00W, 10.0V@1.8A, Pin Out: Center Positive (+V), symbol compliant with IEC 60417 symbol no. 5926, Output Configuration: 1500 mm, 20/2 Cond, UL 2468, Female Barrel 5.5*2.1*11mm w/ Spring Clip & Locking Notch or Equal, Ferrite: None, GlobTek Black, GT Cord # C5034, Blades/Input Cord: (Order Separately), Approvals:	
	Model No. GT-86181-1810 -W2	
	Part No./Ordering No. WR9HU1800CCP-F(R6B)	Rev A

REVISION HISTORY

REV	DESCRIPTION	SUB	DATE	APPROVED
A	Initial Release	fclif	04/23/2019	QA

POWER SUPPLY INFORMATION

TYPE	Wall Plug-in
TECHNOLOGY	Regulated Switchmode AC-DC Power Supply AC Adaptor
CASE COLOR	GlobTek Black
NAMEPLATE RATED INPUT	100-240V- , 50/60Hz, 0.6 A
INPUT CONFIG	N. America NEMA 1-15 Fixed
WATTS	18.00
VOLTS OUT	10.0
CURRENT OUT (Amps)	1.8
BLADE/CORD INCLUDED	None (Order Separately)
BLADE/CORD INSTALLED	None :(Order Separately)
INGRESS PROTECTION	Indoor Use
GROUNDING CONFIGURATION	(F1) Floating output, Class II / double insulated
EFFICIENCY LEVEL	USA DOE Level VI / Eco-design Directive 2009/125/EC, (EU) 2019/1782
OUTPUT CONFIGURATION	1500 mm, 20/2 Cond, UL 2468, Female Barrel 5.5*2.1*11mm w/ Spring Clip & Locking Notch or Equal, Ferrite: None, GlobTek Black, GT Cord # C5034
OVERMOLDED	Yes
OUTPUT CONNECTOR GENDER	Female
CONNECTOR PIN OUT	Center Positive (+V), symbol compliant with IEC 60417 symbol no. 5926
LABEL SPECS	Standard GT,L-1186
SPECIAL BARCODE LABEL MATERIAL	No
PACK SPEC	Standard WPI, Cellular packaging
USER MANUAL	

PROPRIETARY INFORMATION

GlobTek, Inc. www.globtek.com 186 Veterans Drive, Northvale, NJ 07647 Tel. (201) 784-1000 Fax (201) 784-0111	Drawing Title: GT-86181-1810 -W2, ICT/ITE Power Supply, Efficiency Level: USA DOE Level VI / Eco-design Directive 2009/125/EC, (EU) 2019/1782, Case Color/Style: GlobTek Black, Wall Plug-in, Regulated Switchmode AC-DC Power Supply AC Adaptor, Input Rating: 100-240V- , 50/60Hz, N. America NEMA 1-15 Fixed, , Output Rating: 18.00W, 10.0V@1.8A, Pin Out: Center Positive (+V), symbol compliant with IEC 60417 symbol no. 5926, Output Configuration: 1500 mm, 20/2 Cond, UL 2468, Female Barrel 5.5*2.1*11mm w/ Spring Clip & Locking Notch or Equal, Ferrite: None, GlobTek Black, GT Cord # C5034, Blades/Input Cord: (Order Separately), Approvals:	
	Model No. GT-86181-1810 -W2	
	Part No./Ordering No. WR9HU1800CCP-F(R6B)	Rev A

Notes/Modifications/Customizations (notes in this section supersede the values shown in the standard spec)

DIMENSIONS ARE IN MM UNLESS SPECIFIED OTHERWISE

GloTek, Inc. www.globtek.com 186 Veterans Drive, Northvale, NJ 07647 Tel. (201) 784-1000 Fax (201) 784-0111	Drawing Title: GT-86181-1810 -W2, ICT/ITE Power Supply, Efficiency Level: USA DOE Level VI / Eco-design Directive 2009/125/EC, (EU) 2019/1782, Case Color/Style: GlobTek Black, Wall Plug-in, Regulated Switchmode AC-DC Power Supply AC Adaptor, Input Rating: 100-240V- , 50/60Hz, N. America NEMA 1-15 Fixed, , Output Rating: 18.00W, 10.0V@1.8A, Pin Out: Center Positive (+V), symbol compliant with IEC 60417 symbol no. 5926, Output Configuration: 1500 mm, 20/2 Cond, UL 2468, Female Barrel 5.5*2.1*11mm w/ Spring Clip & Locking Notch or Equal, Ferrite: None, GlobTek Black, GT Cord # C5034, Blades/Input Cord: (Order Separately), Approvals:	
	Model No. GT-86181-1810 -W2	
	Part No./Ordering No. WR9HU1800CCP-F(R6B)	Rev A

ELECTRICAL SPECIFICATIONS

A) ELECTRICAL SPECIFICATIONS:

01. Input Voltage: Specified 90-264 Vac, Nameplate rated: 100-240Vac
02. Input Frequency: Specified 47-63 Hz, Nameplate rated 50-60Hz
03. Inrush Current: at full load, 25° C, cold start
04. Efficiency: Compliant with Efficiency Level VI and CoC Tier 2 standards
05. No Load Standby Power: <0.075W @ 230Vac
06. Line regulation: ±2% At nominal input voltage and full load
07. Total output regulation: ± 5%
08. Output Voltage: Tolerance ± 5%
09. Turn On Delay: 3 Seconds maximum at nominal input Voltage
10. Hold Up Time: 5ms min at nominal Input Voltage
11. Ripple Voltage: 300 mVp-p At 20 MHz, and output parallel with Low Impedance 0.1uF & 47uF capacitors. Temperature at 25°C, and nominal input voltage

B) PROTECTION

01. Over voltage protection: Output shut down and auto restart
02. Short circuit protection: The adapter shall not be damaged by short the DC output to Ground
03. Over Load Protection: Output shut down and auto restart

C) SAFETY

01. HI-POT : Input to output : 3000VAC or 4242VDC 10mA 1 minute
02. Leakage current: 0.25mA maximum, at nominal AC input voltage and frequency
03. ESD: 8KV(air) / 4KV (contact)

D) OTHER:

01. MTBF: 200,000 Hours @ 25°C ambient temperature
02. Operating Temperature: 0°C to 40°C ambient temperature
03. Humidity Operating : 20% to 85%
04. Storage Temperature: -20°C to 60°C
05. RoHS 2: Complies with EU 2011/65/EU and China GB/T26572-2011

E) ENCLOSURE

01. Housing: High impact plastic, 94V0 polycarbonate, non-vented
02. Size: 74.5 (L) * 36 (W) * 46(H) mm maximum
03. Weight : 107.0 g ±15%
04. Markings: Label and/or Pad Printed and/or Molded in the case

TO ADDRESS SYSTEM-LEVEL EMI CONCERNS, FERRITE CHOKES/BEADS MAY BE ADDED/REVISED UPON REQUEST. A SAMPLE KIT OF GLOBTEK'S STANDARD FERRITES IS AVAILABLE UNDER GLOBTEK P/N: EMI-MITIGATION-KIT1

FOR ADDITIONAL INFORMATION, PLEASE READ OUR WHITE PAPER AT: <https://r.globtek.info/3QeaqtD>

PROPRIETARY INFORMATION

PROPRIETARY OF GLOBTEK, INC. ANY REPRODUCTION, DISCLOSURE OR USE OF THIS DRAWING, IN WHOLE OR IN PART, IS HEREBY PROHIBITED EXCEPT AS SPECIFIED IN WRITING BY GLOBTEK, INC. © GlobTek, Inc. 2019 - 2024

quest / 07/13/2024 12:03:01 AM GMT CLONED FROM WR9HU1800LCP-F(R6B)

<p>GlobTek, Inc. www.globtek.com 186 Veterans Drive, Northvale, NJ 07647 Tel. (201) 784-1000 Fax (201) 784-0111</p>	<p>Drawing Title: GT-86181-1810 -W2, ICT/ITE Power Supply, Efficiency Level: USA DOE Level VI / Eco-design Directive 2009/125/EC, (EU) 2019/1782, Case Color/Style: GlobTek Black, Wall Plug-in, Regulated Switchmode AC-DC Power Supply AC Adaptor, Input Rating: 100-240V- , 50/60Hz, N. America NEMA 1-15 Fixed, , Output Rating: 18.00W, 10.0V@1.8A, Pin Out: Center Positive (+V), symbol compliant with IEC 60417 symbol no. 5926, Output Configuration: 1500 mm, 20/2 Cond, UL 2468, Female Barrel 5.5*2.1*11mm w/ Spring Clip & Locking Notch or Equal, Ferrite: None, GlobTek Black, GT Cord # C5034, Blades/Input Cord: (Order Separately), Approvals:</p>
	<p>Model No. GT-86181-1810 -W2</p>
	<p>Part No./Ordering No. WR9HU1800CCP-F(R6B) Rev A</p>

INGRESS PROTECTION: Indoor Use

<p>GlobTek, Inc. www.globtek.com 186 Veterans Drive, Northvale, NJ 07647 Tel. (201) 784-1000 Fax (201) 784-0111</p>	<p>Drawing Title: GT-86181-1810 -W2, ICT/ITE Power Supply, Efficiency Level: USA DOE Level VI / Eco-design Directive 2009/125/EC, (EU) 2019/1782, Case Color/Style: GlobTek Black, Wall Plug-in, Regulated Switchmode AC-DC Power Supply AC Adaptor, Input Rating: 100-240V- , 50/60Hz, N. America NEMA 1-15 Fixed, , Output Rating: 18.00W, 10.0V@1.8A, Pin Out: Center Positive (+V), symbol compliant with IEC 60417 symbol no. 5926, Output Configuration: 1500 mm, 20/2 Cond, UL 2468, Female Barrel 5.5*2.1*11mm w/ Spring Clip & Locking Notch or Equal, Ferrite: None, GlobTek Black, GT Cord # C5034, Blades/Input Cord: (Order Separately), Approvals:</p> <p>Model No. GT-86181-1810 -W2</p> <p>Part No./Ordering No. WR9HU1800CCP-F(R6B)</p>	<p>Rev A</p>
--	--	--------------

3D File Download https://www.globtek.com/file/dl/6014_obsolete_model.stp

Mechanical drawing

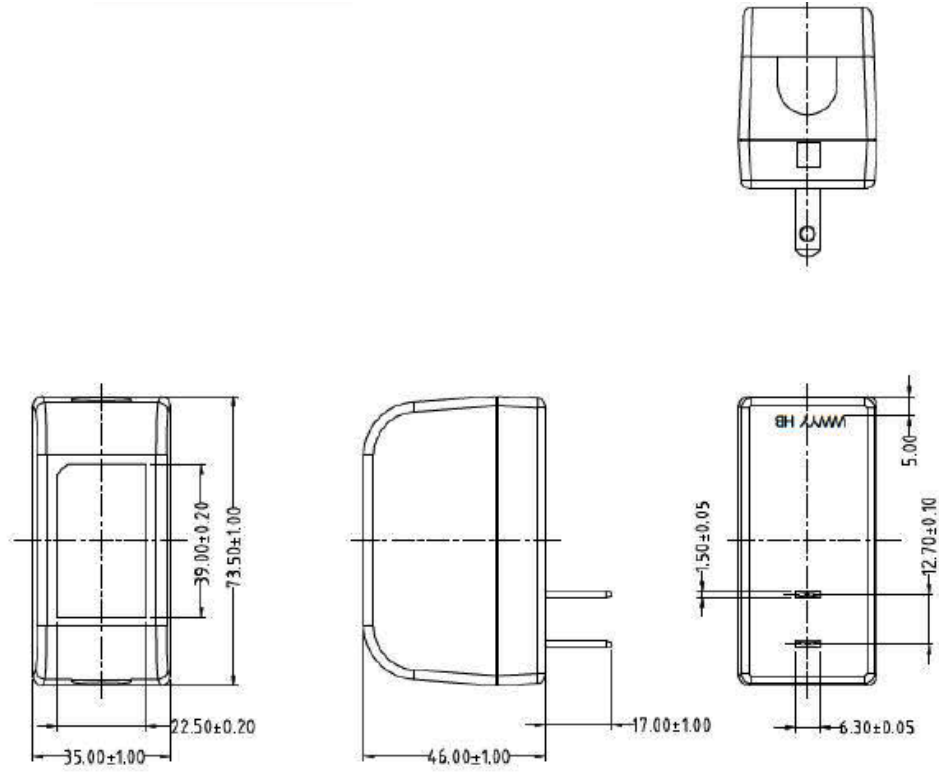

GlobTek, Inc.
 www.globtek.com
 186 Veterans Drive,
 Northvale, NJ 07647
 Tel. (201) 784-1000
 Fax (201) 784-0111

Drawing Title: GT-86181-1810 -W2, ICT/ITE Power Supply, Efficiency Level: USA DOE Level VI / Eco-design Directive 2009/125/EC, (EU) 2019/1782, Case Color/Style: GlobTek Black, Wall Plug-in, Regulated Switchmode AC-DC Power Supply AC Adaptor, Input Rating: 100-240V- , 50/60Hz, N. America NEMA 1-15 Fixed, , Output Rating: 18.00W, 10.0V@1.8A, Pin Out: Center Positive (+V), symbol compliant with IEC 60417 symbol no. 5926, Output Configuration: 1500 mm, 20/2 Cond, UL 2468, Female Barrel 5.5*2.1*11mm w/ Spring Clip & Locking Notch or Equal, Ferrite: None, GlobTek Black, GT Cord # C5034, Blades/Input Cord: (Order Separately), Approvals:

Model No. GT-86181-1810 -W2

Part No./Ordering No. WR9HU1800CCP-F(R6B)

Rev A

DERATING CURVE

w2

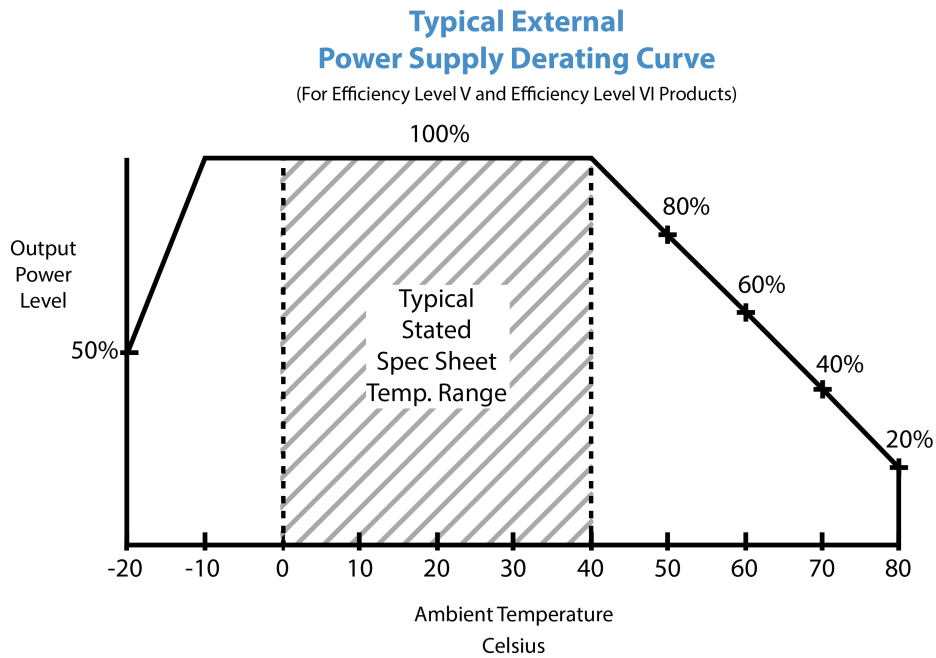

<p>GlobTek, Inc. www.globtek.com 186 Veterans Drive, Northvale, NJ 07647 Tel. (201) 784-1000 Fax (201) 784-0111</p>	<p>Drawing Title: GT-86181-1810 -W2, ICT/ITE Power Supply, Efficiency Level: USA DOE Level VI / Eco-design Directive 2009/125/EC, (EU) 2019/1782, Case Color/Style: GlobTek Black, Wall Plug-in, Regulated Switchmode AC-DC Power Supply AC Adaptor, Input Rating: 100-240V- , 50/60Hz, N. America NEMA 1-15 Fixed, , Output Rating: 18.00W, 10.0V@1.8A, Pin Out: Center Positive (+V), symbol compliant with IEC 60417 symbol no. 5926, Output Configuration: 1500 mm, 20/2 Cond, UL 2468, Female Barrel 5.5*2.1*11mm w/ Spring Clip & Locking Notch or Equal, Ferrite: None, GlobTek Black, GT Cord # C5034, Blades/Input Cord: (Order Separately), Approvals:</p>
	<p>Model No. GT-86181-1810 -W2</p>
	<p>Part No./Ordering No. WR9HU1800CCP-F(R6B) Rev A</p>

INPUT CONFIGURATION

(F1) Floating output, Class II / double insulated

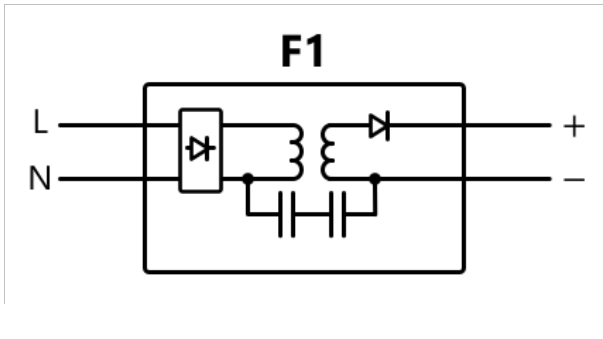

[Alternate grounding configurations](#) available upon request.

Blades/Cord Included:None:(Order Separately)

Blades/Cord Installed:None:(Order Separately)

NEMA 1-15P

NEMA 1-15P, North America Blades, Class II 2 Conductors

All NEMA 1 devices are two-wire non-grounding devices (hot-neutral) rated for 125 V maximum. NEMA 1-15P plugs have two parallel flat blades, 0.25 inches (6.35 mm) wide, 0.06 inches (1.524 mm) thick, 0.625-0.718 inches (15.875–18.256 mm) long, and spaced 0.5 inches (12.7 mm) apart.

GlobTek, Inc. www.globtek.com 186 Veterans Drive, Northvale, NJ 07647 Tel. (201) 784-1000 Fax (201) 784-0111	Drawing Title: GT-86181-1810 -W2, ICT/ITE Power Supply, Efficiency Level: USA DOE Level VI / Eco-design Directive 2009/125/EC, (EU) 2019/1782, Case Color/Style: GlobTek Black, Wall Plug-in, Regulated Switchmode AC-DC Power Supply AC Adaptor, Input Rating: 100-240V- , 50/60Hz, N. America NEMA 1-15 Fixed, , Output Rating: 18.00W, 10.0V@1.8A, Pin Out: Center Positive (+V), symbol compliant with IEC 60417 symbol no. 5926, Output Configuration: 1500 mm, 20/2 Cond, UL 2468, Female Barrel 5.5*2.1*11mm w/ Spring Clip & Locking Notch or Equal, Ferrite: None, GlobTek Black, GT Cord # C5034, Blades/Input Cord: (Order Separately), Approvals:	
	Model No. GT-86181-1810 -W2	
	Part No./Ordering No. WR9HU1800CCP-F(R6B)	Rev A

OUTPUT CORD AND CONNECTOR: CL1/C5034

ACTUAL CONNECTORS, OVERMOLDS, FERRITES MAY VARY SLIGHTLY FROM THE PICTURE BELOW

CABLE TYPE	UL 2468
CABLE LENGTH (mm)	1500
CABLE TOLERANCE (mm)	+150-0
WIRE GAUGE (AWG)	20
CONDUCTORS	2
HANK DIMENSION (mm)	70 ± 10
CABLE / CONNECTOR OVERMOLD COLOR	GlobTek Black
FERRITE TYPE AND DIMENSION	None
FERRITE NUMBER OF TURNS (Definition)	N/A
FERRITE DIMENSION FROM STRAIN RELIEF	N/A
FERRITE DIMENSION FROM PLUG	N/A
PLUG TYPE	Female Barrel 5.5*2.1*11mm w/ Spring Clip & Locking Notch or Equal
OUTPUT CONNECTOR GENDER	Female
OVERMOLDED	Yes
OVER MOLD ORIENTATION	Straight
CONNECTOR PIN OUT	Center Positive (+V), symbol compliant with IEC 60417 symbol no. 5926

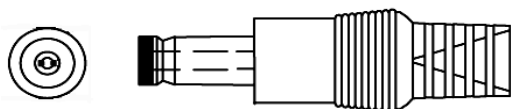

ADDITIONAL OUTPUT PLUG OPTIONS ARE AVAILABLE AT <https://www.globtek.com/en/connectors>
STANDARD PLUGS AND CONNECTORS CAN BE SEEN ONLINE AT <https://www.globtek.com/en/connectors>
CALCULATE VOLTAGE REGULATION/DROP WITH OUR ONLINE CALCULATOR: <https://www.globtek.com/r2/PtgjL>

<p>GlobTek, Inc. www.globtek.com 186 Veterans Drive, Northvale, NJ 07647 Tel. (201) 784-1000 Fax (201) 784-0111</p>	<p>Drawing Title: GT-86181-1810 -W2, ICT/ITE Power Supply, Efficiency Level: USA DOE Level VI / Eco-design Directive 2009/125/EC, (EU) 2019/1782, Case Color/Style: GlobTek Black, Wall Plug-in, Regulated Switchmode AC-DC Power Supply AC Adaptor, Input Rating: 100-240V- , 50/60Hz, N. America NEMA 1-15 Fixed, , Output Rating: 18.00W, 10.0V@1.8A, Pin Out: Center Positive (+V), symbol compliant with IEC 60417 symbol no. 5926, Output Configuration: 1500 mm, 20/2 Cond, UL 2468, Female Barrel 5.5*2.1*11mm w/ Spring Clip & Locking Notch or Equal, Ferrite: None, GlobTek Black, GT Cord # C5034, Blades/Input Cord: (Order Separately), Approvals:</p>
	<p>Model No. GT-86181-1810 -W2</p>
	<p>Part No./Ordering No. WR9HU1800CCP-F(R6B)</p>
	<p>Rev A</p>

OUTPUT CONNECTOR HOOK UP

TO ADDRESS SYSTEM-LEVEL EMI CONCERNS, FERRITE CHOKES/BEADS MAY BE ADDED/REVISED UPON REQUEST. A SAMPLE KIT OF GLOBTEK'S STANDARD FERRITES IS AVAILABLE UNDER GLOBTEK P/N: EMI-MITIGATION-KIT1

FOR ADDITIONAL INFORMATION, PLEASE READ OUR WHITE PAPER AT:

<https://www.globtek.com/en/technical-articles/ferrite-kit-radiated-emi-suppression-kit-for-globtek-power-supplies-cable-assemblies>

GlobTek, Inc. www.globtek.com 186 Veterans Drive, Northvale, NJ 07647 Tel. (201) 784-1000 Fax (201) 784-0111	Drawing Title: GT-86181-1810 -W2, ICT/ITE Power Supply, Efficiency Level: USA DOE Level VI / Eco-design Directive 2009/125/EC, (EU) 2019/1782, Case Color/Style: GlobTek Black, Wall Plug-in, Regulated Switchmode AC-DC Power Supply AC Adaptor, Input Rating: 100-240V- , 50/60Hz, N. America NEMA 1-15 Fixed, , Output Rating: 18.00W, 10.0V@1.8A, Pin Out: Center Positive (+V), symbol compliant with IEC 60417 symbol no. 5926, Output Configuration: 1500 mm, 20/2 Cond, UL 2468, Female Barrel 5.5*2.1*11mm w/ Spring Clip & Locking Notch or Equal, Ferrite: None, GlobTek Black, GT Cord # C5034, Blades/Input Cord: (Order Separately), Approvals:	
	Model No. GT-86181-1810 -W2	
	Part No./Ordering No. WR9HU1800CCP-F(R6B)	Rev A

LABEL:L-1186

LABEL P/N	Standard GT
MATERIAL	Flat Thermal Transfer, Imprintable, Polyester Label and/or Pad Printed and/or Molded, and/or Laser Engraved in the case
BACKGROUND COLOR	Black if housing is Black, White or Silver if housing is White or Gray.
TEXT COLOR	White or Silver if label is Black Background for Black housing. Black if label is White or Silver background and Housing is White or Gray.
LABEL WIDTH (mm)	38.6
LABEL HEIGHT (mm)	22.1
SPECIAL BARCODE LABEL MATERIAL	No

Below is the minimum information which will appear on the label. NOTE: in the logo area additional/actual positioning of symbols and text is subjected to change as per agency updates/requirements or additional model approvals become available.
Regulatory certifications/label markings may be in logo area on the label or molded into the case housing outside the label area.
Information will be shown via label and/or pad printed and/or molded and/or laser engraved in the case. * Date code markings at GlobTek option

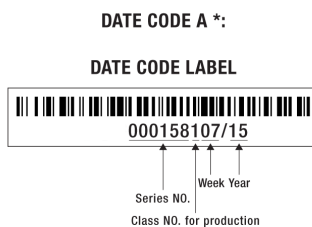

or
DATE CODE B*:

WWYY
WW = WEEK
YY = YEAR

- A=ICT/ITE Power Supply
- B=P/N: (料号) WR9HU1800CCP-F(R6B)
- C=Model (型号) GT-86181-1810 -W2
- D=Input (输入)100-240V- , 50/60Hz, 0.6 A
- E=Output (输出)10.0 V \equiv 1.8 A, 18.00W

GlobTek, Inc. www.globtek.com 186 Veterans Drive, Northvale, NJ 07647 Tel. (201) 784-1000 Fax (201) 784-0111	Drawing Title: GT-86181-1810 -W2, ICT/ITE Power Supply, Efficiency Level: USA DOE Level VI / Eco-design Directive 2009/125/EC, (EU) 2019/1782, Case Color/Style: GlobTek Black, Wall Plug-in, Regulated Switchmode AC-DC Power Supply AC Adaptor, Input Rating: 100-240V- , 50/60Hz, N. America NEMA 1-15 Fixed, , Output Rating: 18.00W, 10.0V@1.8A, Pin Out: Center Positive (+V), symbol compliant with IEC 60417 symbol no. 5926, Output Configuration: 1500 mm, 20/2 Cond, UL 2468, Female Barrel 5.5*2.1*11mm w/ Spring Clip & Locking Notch or Equal, Ferrite: None, GlobTek Black, GT Cord # C5034, Blades/Input Cord: (Order Separately), Approvals:	
	Model No. GT-86181-1810 -W2	
	Part No./Ordering No. WR9HU1800CCP-F(R6B)	Rev A

AGENCY ONLINE DOCUMENTS	http://www.globtek.info/certs/GT-86181-W2/
CE EC-Declaration for Medical	Contact GlobTek for more information
CE EC-Declaration for Industrial/Commercial/ITE	https://cs.globtek.info/ec_declaration_product?id=01t0c0000097CM7&i=2
CE EC-Declaration for Household	Contact GlobTek for more information
UKCA-Declaration for Medical	Contact GlobTek for more information
UKCA-Declaration for Industrial/Commercial/ITE	https://cs.globtek.info/ukca_declaration_product?id=01t0c0000097CM7&i=2
UKCA-Declaration for Household	Contact GlobTek for more information
Morocco SDoC Declaration	https://cs.globtek.info/Morocco_SDoC_Declaration?id=a0Oa000000FlgfoEAB
RoHS/RoHS3 Declaration	https://www.globtek.com/pdf/rohs_cert/01t0c0000097CM7AAM
REACH Declaration	https://www.globtek.com/pdf/iso_certificates/REACH.pdf
Conflict Minerals Declaration	https://www.globtek.com/pdf/conflict-minerals.pdf
Prop 65 Statement	https://www.globtek.com/prop-65-statement.pdf

IPXY rating is based on 3rd party testing and customers should check suitability and test system level IPXY rating before ordering.

Regulatory Certifications/Label Markings

Below follows a link to the latest regulatory certifications and marks for this specific product. National standards as well as certification schemes are constantly changing and so is the set of certification marks and symbols applicable to this product. Various standards, marks and symbols, and certificates are subject to change at any time without notice.

Additional standards or unique country certifications are available upon request. Please contact Globtek to request a quotation.

LATEST PRODUCT/MODEL CERTIFICATIONS: <https://www.globtek.com/ds/f7LDNw39di2/WckbGQUcPmH.html>

AGENCY ONLINE DOCUMENTS <http://www.globtek.info/certs/GT-86181-W2/>
(F1) Floating output, Class II / double insulated

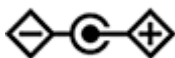

Center Positive (+V), symbol compliant with IEC 60417 symbol no. 5926

GlobTek, Inc. www.globtek.com 186 Veterans Drive, Northvale, NJ 07647 Tel. (201) 784-1000 Fax (201) 784-0111	Drawing Title: GT-86181-1810 -W2, ICT/ITE Power Supply, Efficiency Level: USA DOE Level VI / Eco-design Directive 2009/125/EC, (EU) 2019/1782, Case Color/Style: GlobTek Black, Wall Plug-in, Regulated Switchmode AC-DC Power Supply AC Adaptor, Input Rating: 100-240V- , 50/60Hz, N. America NEMA 1-15 Fixed, , Output Rating: 18.00W, 10.0V@1.8A, Pin Out: Center Positive (+V), symbol compliant with IEC 60417 symbol no. 5926, Output Configuration: 1500 mm, 20/2 Cond, UL 2468, Female Barrel 5.5*2.1*11mm w/ Spring Clip & Locking Notch or Equal, Ferrite: None, GlobTek Black, GT Cord # C5034, Blades/Input Cord: (Order Separately), Approvals:	
	Model No. GT-86181-1810 -W2	
	Part No./Ordering No. WR9HU1800CCP-F(R6B)	Rev A

PACKAGING

Packing Spec P/N	Standard WPI, Cellular packaging
Packing Quantity/Multiple/MPQ	120
Gift Box Size (mm)	Cellular Packaing
Gift Box Color	None
Master Carton Size (mm)	525 x 335 x 300
Master Carton Cubic Volume (m³)	0.05
Master GW (Kg)	0.0 kg
BLADES INCLUDED	None: (Order Separately)
BLADE/CORD INSTALLED	None: (Order Separately)
USER MANUAL*	
USER MANUAL WEB LINK	

* This specification sheet is considered the user manual for all applications. It is expected that the buyer of this product will use it to formulate their own user manual for their end product and a user manual specifically for the power adapter is not usually required. If a user manual is not specifically listed above then none will be provided with this unit.

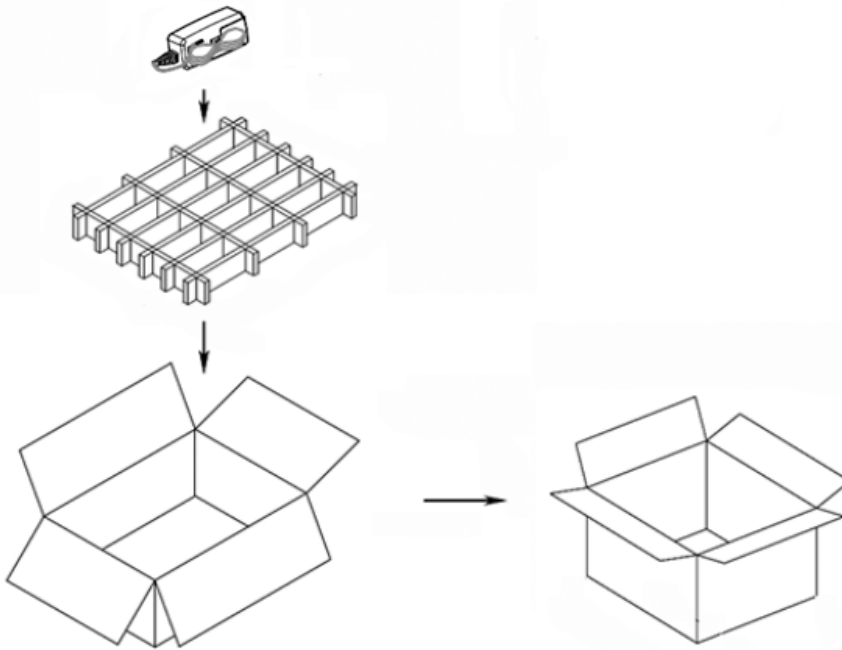

PROPRIETARY INFORMATION

<p>GlobTek, Inc. www.globtek.com 186 Veterans Drive, Northvale, NJ 07647 Tel. (201) 784-1000 Fax (201) 784-0111</p>	<p>Drawing Title: GT-86181-1810 -W2, ICT/ITE Power Supply, Efficiency Level: USA DOE Level VI / Eco-design Directive 2009/125/EC, (EU) 2019/1782, Case Color/Style: GlobTek Black, Wall Plug-in, Regulated Switchmode AC-DC Power Supply AC Adaptor, Input Rating: 100-240V- , 50/60Hz, N. America NEMA 1-15 Fixed, , Output Rating: 18.00W, 10.0V@1.8A, Pin Out: Center Positive (+V), symbol compliant with IEC 60417 symbol no. 5926, Output Configuration: 1500 mm, 20/2 Cond, UL 2468, Female Barrel 5.5*2.1*11mm w/ Spring Clip & Locking Notch or Equal, Ferrite: None, GlobTek Black, GT Cord # C5034, Blades/Input Cord: (Order Separately), Approvals:</p>
	<p>Model No. GT-86181-1810 -W2</p>
	<p>Part No./Ordering No. WR9HU1800CCP-F(R6B)</p>
	<p>Rev A</p>

INSTRUCTIONS TO THE OEM SYSTEMS ENGINEER

It is the responsibility of the OEM systems engineer to provide the end system user instructions and warnings for the use of this product in the end system.

If an input cord is required for this product, AC Mains voltage should be provided to the power supply by a power supply cord approved to the national standards of the country in which it will be used.

This product is not designed to be repaired. No serviceable parts inside. A blown internal fuse is an indication of catastrophic failure of circuit component(s). If a Failure Analysis is required for a failed power supply/battery charger, please return the damaged unit to GlobTek for an accurate determination of the root cause of the failure.

EMC Compliance of the complete OEM product, including the GlobTek power supply/battery charger needs to be verified by the OEM systems engineer.

GlobTek, Inc. www.globtek.com 186 Veterans Drive, Northvale, NJ 07647 Tel. (201) 784-1000 Fax (201) 784-0111	Drawing Title: GT-86181-1810 -W2, ICT/ITE Power Supply, Efficiency Level: USA DOE Level VI / Eco-design Directive 2009/125/EC, (EU) 2019/1782, Case Color/Style: GlobTek Black, Wall Plug-in, Regulated Switchmode AC-DC Power Supply AC Adaptor, Input Rating: 100-240V- , 50/60Hz, N. America NEMA 1-15 Fixed, , Output Rating: 18.00W, 10.0V@1.8A, Pin Out: Center Positive (+V), symbol compliant with IEC 60417 symbol no. 5926, Output Configuration: 1500 mm, 20/2 Cond, UL 2468, Female Barrel 5.5*2.1*11mm w/ Spring Clip & Locking Notch or Equal, Ferrite: None, GlobTek Black, GT Cord # C5034, Blades/Input Cord: (Order Separately), Approvals:	
	Model No. GT-86181-1810 -W2	
	Part No./Ordering No. WR9HU1800CCP-F(R6B)	Rev A

INSTRUCTION SHEET

<p>GlobTek, Inc. www.globtek.com 186 Veterans Drive, Northvale, NJ 07647 Tel. (201) 784-1000 Fax (201) 784-0111</p>	<p>Drawing Title: GT-86181-1810 -W2, ICT/ITE Power Supply, Efficiency Level: USA DOE Level VI / Eco-design Directive 2009/125/EC, (EU) 2019/1782, Case Color/Style: GlobTek Black, Wall Plug-in, Regulated Switchmode AC-DC Power Supply AC Adaptor, Input Rating: 100-240V- , 50/60Hz, N. America NEMA 1-15 Fixed, , Output Rating: 18.00W, 10.0V@1.8A, Pin Out: Center Positive (+V), symbol compliant with IEC 60417 symbol no. 5926, Output Configuration: 1500 mm, 20/2 Cond, UL 2468, Female Barrel 5.5*2.1*11mm w/ Spring Clip & Locking Notch or Equal, Ferrite: None, GlobTek Black, GT Cord # C5034, Blades/Input Cord: (Order Separately), Approvals:</p>
	<p>Model No. GT-86181-1810 -W2</p>
	<p>Part No./Ordering No. WR9HU1800CCP-F(R6B) Rev A</p>

