

CHEMI-CON SUPERCAPACITOR

Radial Lead type

DLCAP™ DKA series



Sleeveless type

- Very low DCIR even at low and high temperature.
- Uses highly safe electrolyte.
- Ideal as a backup power supply for automotive electrical components.

◆ SPECIFICATIONS

Items	Specifications	
Operating Temperature	-40°C ~ +70°C	
Capacitance Tolerance	φ 18×26L ±20%(M), φ 18×50L ±10%(K) (25°C)	
Temperature Characteristics	Capacitance Change	≤ ±30% of the measured value at 20°C
	Internal Resistance Change	≤ 600% of the internal resistance maximum value given in the ratings tables (-40°C)
Load Life Test	After the capacitors are subjected to the rated DC voltage at 70°C for 1000 hours, the following specifications shall be satisfied when they are restored to 20°C .	
	Capacitance Change	≤ ±30% of the initial measured value at 20°C
	Internal Resistance Change	≤ 200% of the internal resistance maximum value given in the ratings tables
	After the capacitors are subjected to the rated DC voltage at 60°C for 2000 hours, the following specifications shall be satisfied when they are restored to 20°C .	
	Capacitance Change	≤ ±30% of the initial measured value at 20°C
	Internal Resistance Change	≤ 200% of the internal resistance maximum value given in the ratings tables
Bias Humidity Test	After the capacitors are left at 60°C and 90 to 95%RH for 500 hours without voltage applied, the following specifications shall be satisfied when they are restored to 20°C .	
	Capacitance Change	≤ ±30% of the initial measured value at 20°C
	Internal Resistance Change	≤ 200% of the internal resistance maximum value given in the ratings tables

◆ STANDARD RATINGS

● DKA series

Rated Voltage [V]	Capacitance Typ. (rated) [F]	Nominal Case Size		Internal Resistance		Weight* ¹ [g]	Energy Storage* ² [Wh]	Part No.	Note* ³
		φ D [mm]	L [mm]	Typ. [mΩ]	Max. [mΩ]				
2.5	21	18	26	24.8	30.0	9	0.02	DDKA2R5ELL210MM26S	with sleeve (PET)
								DDKA2R5ELL210MM26T	no sleeve, no coating
	50		50	11.0	13.2	18	0.04	DDKA2R5ELL500KM50S	with sleeve (PET)
								DDKA2R5ELL500KM50T	no sleeve, no coating

* 1 Reference data

* 2 Energy Storage (Wh) is calculated based on 「電気及び電子機器用電気二重層キャパシタの輸送に関する手引書」 (Japanese only) by JEITA (It shows up to the second decimal place).

* 3 No sleeve no coating type and sleeve type are the basic specification.

◆ PART NUMBERING SYSTEM

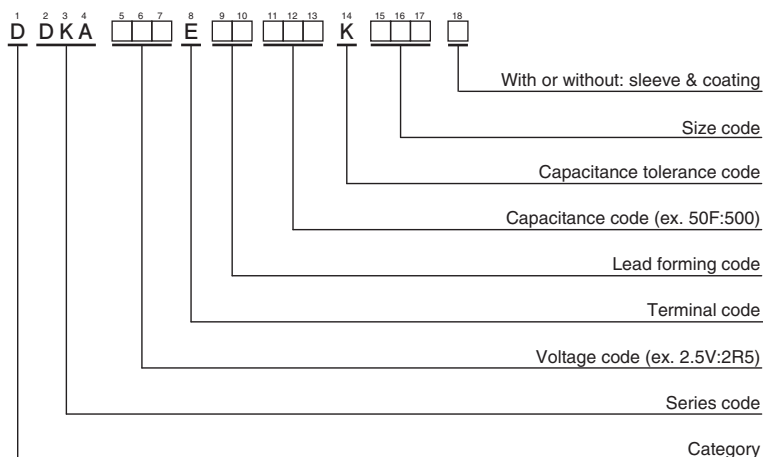

DLCAP™ DKA series

◆ DIMENSIONS [mm]

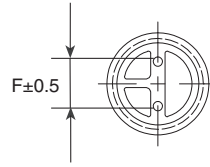
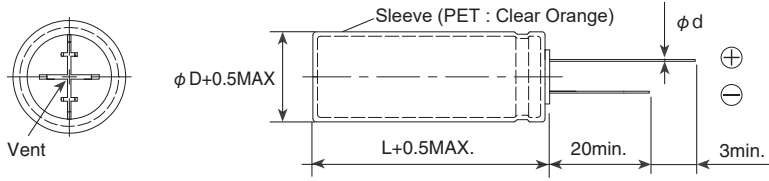

Part No.	L [mm]	F [mm]	ϕd [mm]
DDKA2R5ELL210MM26S	26	7.5	0.8
DDKA2R5ELL500KM50S	50		

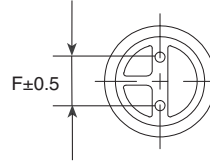
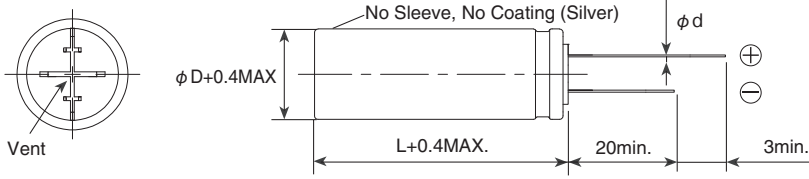

Part No.	L [mm]	F [mm]	ϕd [mm]
DDKA2R5ELL210MM26T	26	7.5	0.8
DDKA2R5ELL500KM50T	50		

Do not use sealing rubber's orientation of this drawing to identify polarity of the actual part. Orientation of sealing rubber and safety vent are not associated.

◆ Temperature Dependence of Capacitance & DCIR

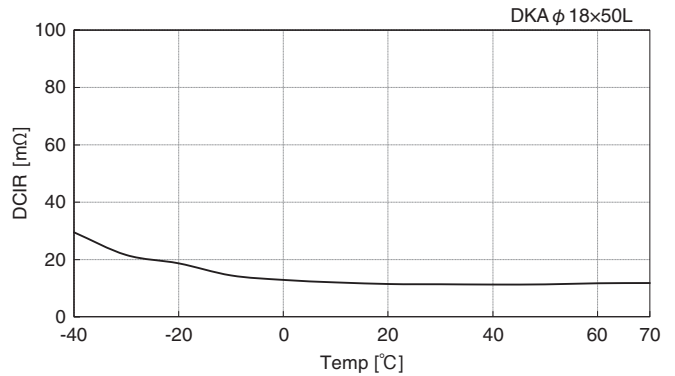
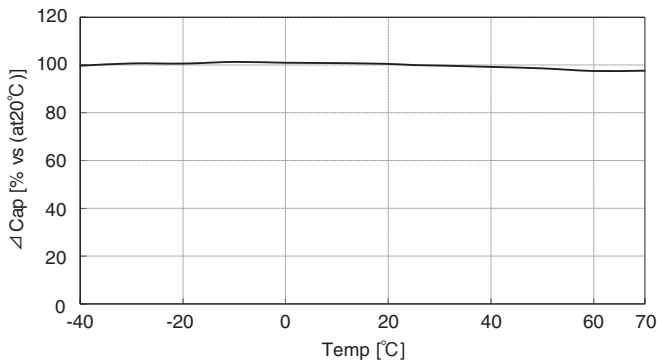

◆ 70°C Load Life Test

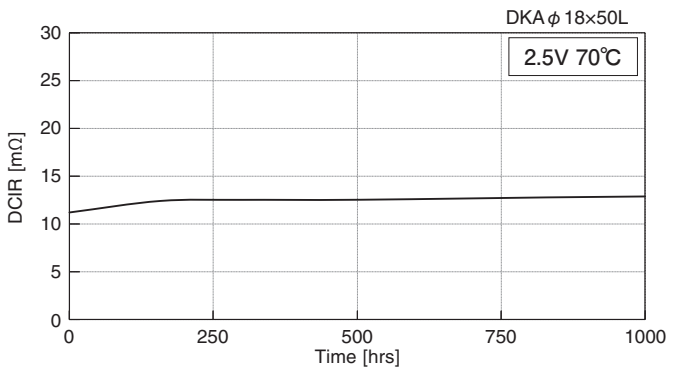
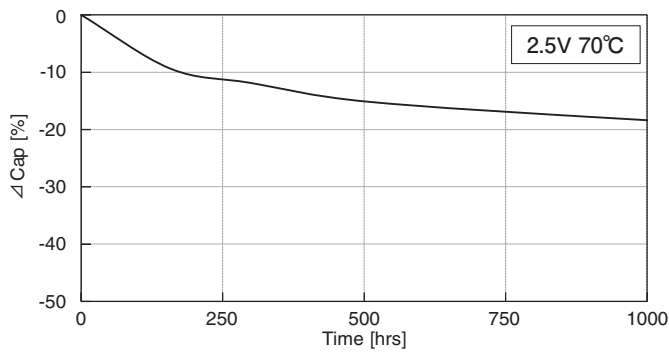

◆ 60°C Load Life Test

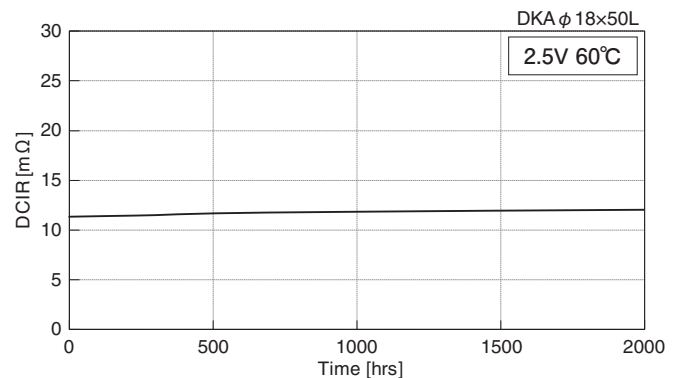
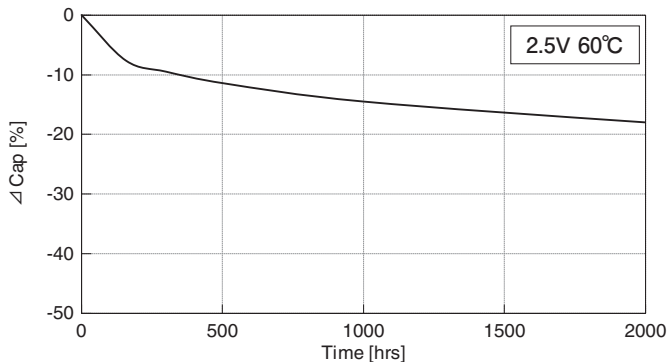



- Always read "Notes on Use" before using the product in order to enable you to use the product correctly and prevent any faults and accidents from occurring.
- Request the Product Specification on the product of NIPPON CHEMI-CON CORPORATION to refer to it as well as this brochure prior to the order of the products. Some specific notes on use of the ordered product may be described in the specifications.
- The products listed in this catalog are designed and manufactured for general electronics equipment use and are not intended for use in applications that can adversely affect human life; where the malfunction of equipment may cause damage to life or property. In addition, our products are not intended to be used in specific applications that may cause a major social impact. Please consult with us in advance of usage of our products in the following listed applications. ① Aerospace equipment ② Power generation equipment such as thermal power, nuclear power etc. ③ Medical equipment ④ Transport equipment (automobiles, trains, ships, etc.) ⑤ Transportation control equipment ⑥ Disaster prevention / crime prevention equipment ⑦ Highly publicized information processing equipment ⑧ Submarine equipment ⑨ Other applications that are not considered general-purpose applications.
- The circuits described as examples in this catalog and the "delivery specifications" are featured in order to show the operations and usage of our products, however, this fact does not guarantee that the circuits are available to function in your equipment systems. We are not in any case responsible for any failures or damage caused by the use of information contained herein. You should examine our products, of which the characteristics are described in the "delivery specifications" and other documents, and determine whether or not our products suit your requirements according to the specifications of your equipment systems. Therefore, you bear final responsibility regarding the use of our products.
Please make sure that you take appropriate safety measures such as use of redundant design and malfunction prevention measures in order to prevent fatal accidents and/or fires in the event any of our products malfunction.
- We strongly recommend our customers to purchase Nippon Chemi-Con products only through our official sales channels. We assume no responsibility for any defects or damages caused by using products purchased from outside our official sales channel or of counterfeit goods. In addition, we will ask the customer to pay the investigation cost for products purchased outside our official sales channel.
- We reserve the right to discontinue production and delivery of products. We do not guarantee that all the products included in this catalog will be available in the future.
The aforementioned does not apply in the case of individual agreements deviating from the foregoing for customer-specific products
- We continually strive to improve the quality and reliability of our products, but in any case that our product does not meet our published specifications, please stop using it promptly and contact us immediately. As for compensation for non-conforming goods delivered by Chemi-Con, we will limit it only to goods found in non-compliance of our published specifications. This may be accomplished by a no cost replacement of non-conforming individual products, a credit of the piece price paid per each individual non-conforming product, or in other ways deemed necessary.
In addition, we have an established system with enhanced traceability, therefore we will limit the applicable lot items for any potential compensation.

[Introduction of Supercapacitors](#)

[Technical Notes](#)

[Precaution Statement](#)