

53426-1 ✓ ACTIVE



PIDG

TE Internal #: 53426-1

Closed Ring Tongue Terminal, 12 – 10 AWG, 1/4 / M6 Stud Size, 6.73 mm [.265 in] Stud Diameter, Closed Barrel, Straight, Tin-Lead, PIDG

[View on TE.com >](#)

Terminals & Splices > Ring Terminals > PIDG Radiation Resistant C Rings/Spades

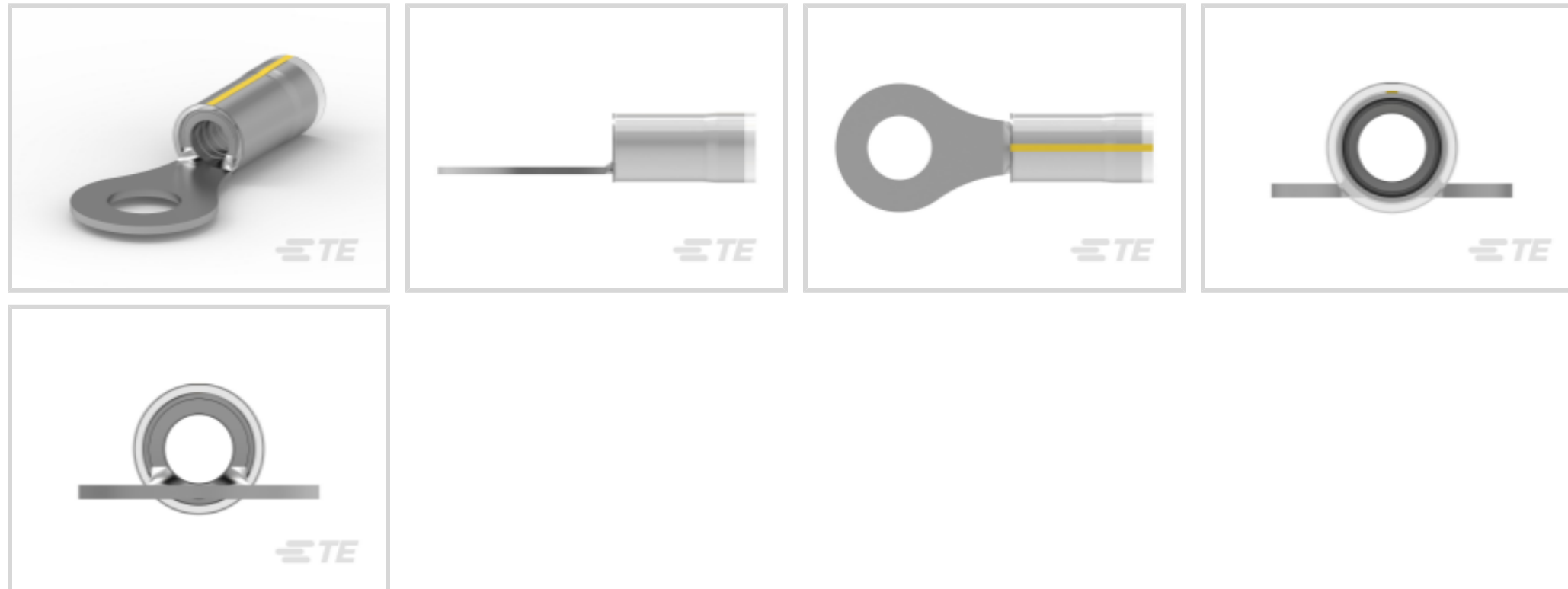

Ring Terminal Product Type: Closed Ring Tongue Terminal

Wire Size: 5180 – 13100 CMA

Stud Size: 1/4, M6

[All PIDG Radiation Resistant C Rings/Spades \(36\)](#)

## Features

### Product Type Features

Ring Terminal Product Type	Closed Ring Tongue Terminal
Stud Size	1/4, M6
Sealable	No
Wire Insulation Support Retention Type	Insulation Support

### Configuration Features

Number of Holes	1
-----------------	---

### Body Features

Insulation Sleeve Color	Natural
Stripe Color	Yellow

### Contact Features

Military Part Class	Class I
Barrel Type	Closed
Terminal Orientation	Straight
Terminal Plating Material	Tin-Lead

### Mechanical Attachment

Wire Insulation Support	With
-------------------------	------

### Dimensions

Wire Size	5180 – 13100 CMA
Stud Diameter	6.73 mm [.265 in]
Tongue Thickness	1.04 mm [.041 in]
Product Length	33.58 mm [1.322 in]
Compatible Insulation Diameter (Max)	5.84 mm [.23 in]
Compatible Insulation Diameter Range	3.81 – 5.84 mm [.15 – .23 in]

### Usage Conditions

Insulation Option	Partially Insulated
Operating Temperature Range	150 °C [302 °F]

### Operation/Application

Compatible With Wire Base Material	Copper
Compatible With Wire Plating Material	Tin

### Industry Standards

Government Qualified Terminal	Yes
-------------------------------	-----

### Packaging Features

Packaging Quantity	500
Packaging Method	Loose Piece

### Product Compliance

[For compliance documentation, visit the product page on TE.com>](#)

EU RoHS Directive 2011/65/EU	Not Compliant
EU ELV Directive 2000/53/EC	Compliant with Exemptions
China RoHS 2 Directive MIIT Order No 32, 2016	Restricted Materials Above Threshold
EU REACH Regulation (EC) No. 1907/2006	Current ECHA Candidate List: JUNE 2024 (241) Candidate List Declared Against: JUNE 2024 (241) SVHC > Threshold: Pb (13% in Component Part)

#### Article Safe Usage Statements:

Do not eat, drink or smoke when using this product. Wash thoroughly after handling. Recycle if possible and dispose of the article by following all applicable governmental regulations relevant to your geographic location.











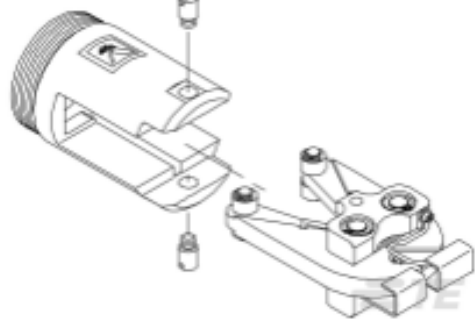

Halogen Content	Not Low Halogen - contains Br or Cl > 900 ppm.
-----------------	--

Solder Process Capability	Not applicable for solder process capability
---------------------------	--

**Product Compliance Disclaimer**

This information is provided based on reasonable inquiry of our suppliers and represents our current actual knowledge based on the information they provided. This information is subject to change. The part numbers that TE has identified as EU RoHS compliant have a maximum concentration of 0.1% by weight in homogenous materials for lead, hexavalent chromium, mercury, PBB, PBDE, DBP, BBP, DEHP, DIBP, and 0.01% for cadmium, or qualify for an exemption to these limits as defined in the Annexes of Directive 2011/65/EU (RoHS2). Finished electrical and electronic equipment products will be CE marked as required by Directive 2011/65/EU. Components may not be CE marked. Additionally, the part numbers that TE has identified as EU ELV compliant have a maximum concentration of 0.1% by weight in homogenous materials for lead, hexavalent chromium, and mercury, and 0.01% for cadmium, or qualify for an exemption to these limits as defined in the Annexes of Directive 2000/53/EC (ELV). Regarding the REACH Regulation, the information TE provides on SVHC in articles for this part number is based on the latest European Chemicals Agency (ECHA) 'Guidance on requirements for substances in articles' posted at this URL: <https://echa.europa.eu/guidance-documents/guidance-on-reach>

## Compatible Parts

 <p>TE Part # 58433-3 PRO CR ASSY, RBY IS9252</p>	 <p>TE Part # 58423-1 DIE, RBY IS9252</p>	 <p>TE Part # 679300-1 1210 PIDG CRIMP HEAD</p>	 <p>TE Part # 59824-1 TETRA-CRIMP PIDG PG FASTON 22-10 ASSY</p>
 <p>TE Part # 59239-4 HHHT PIDG PG 12-10 ASSY</p>	 <p>TE Part # 539691-2 ERGO DIE R.B.Y</p>	 <p>TE Part # 132246-3 TERMINAL RING TONGUE PIDG 22 18</p>	 <p>TE Part # 2063030-1 SDE DIESET, RBY, UL</p>
 <p>TE Part # 47808-6 DIES PIDG 12-10 DIE SET</p>	 <p>TE Part # 169400 CERTI-LOK FRAME W/O DIES</p>	 <p>TE Part # 169404 CERTI-LOK DIE</p>	 <p>TE Part # 1SET191001R0000 CRIMP-HT</p>



## Also in the Series | PIDG

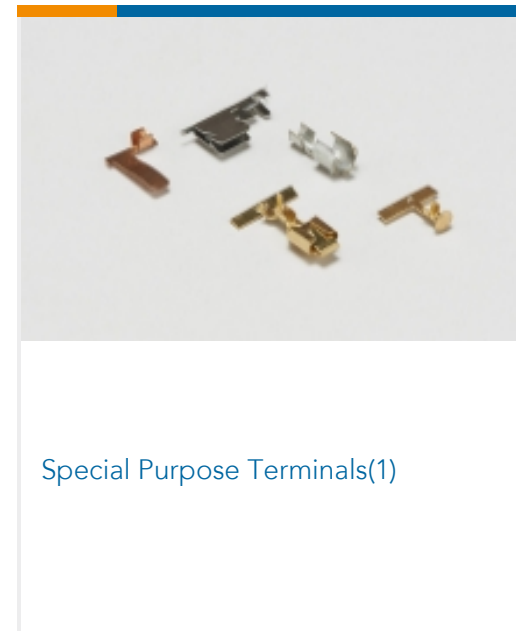
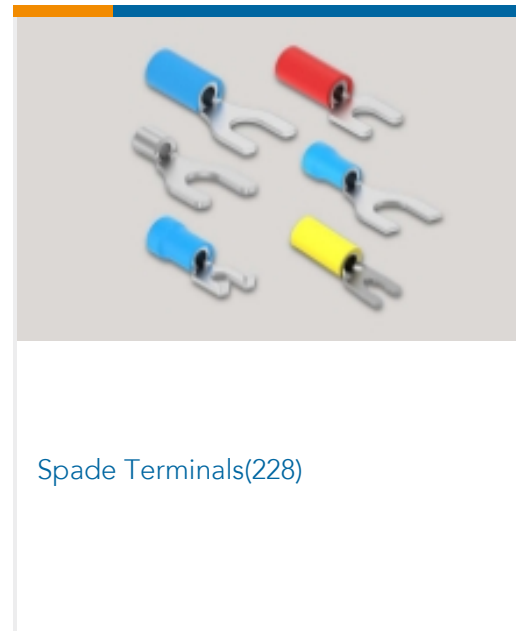
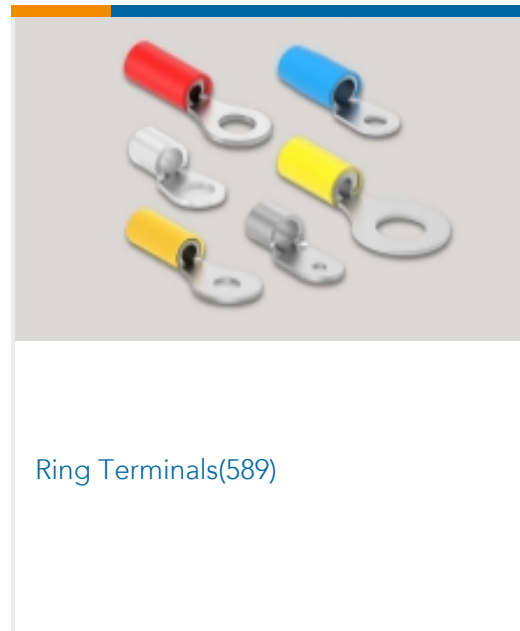
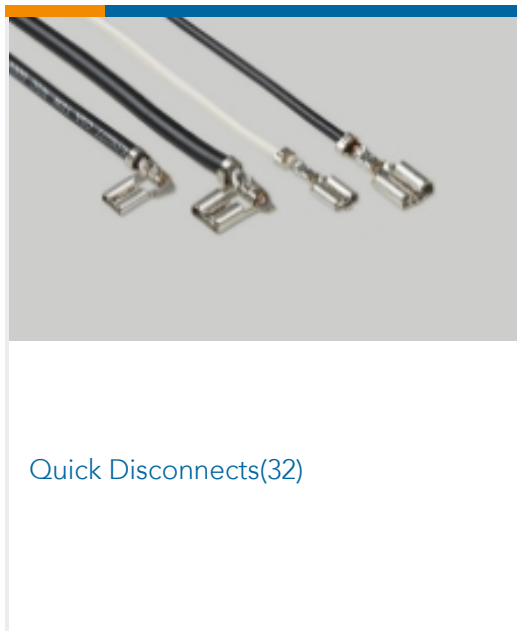
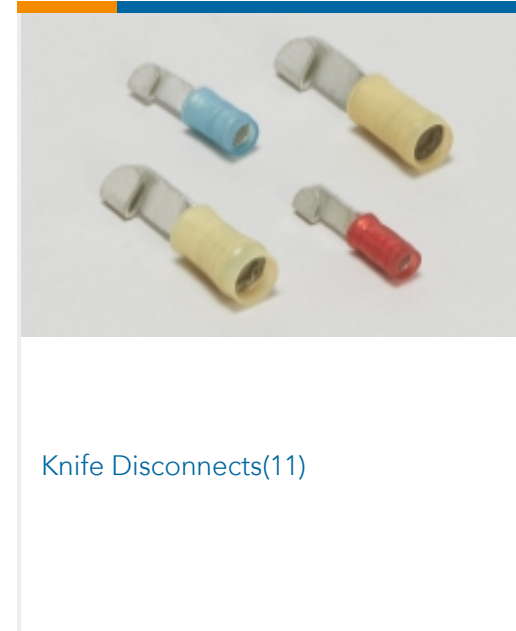
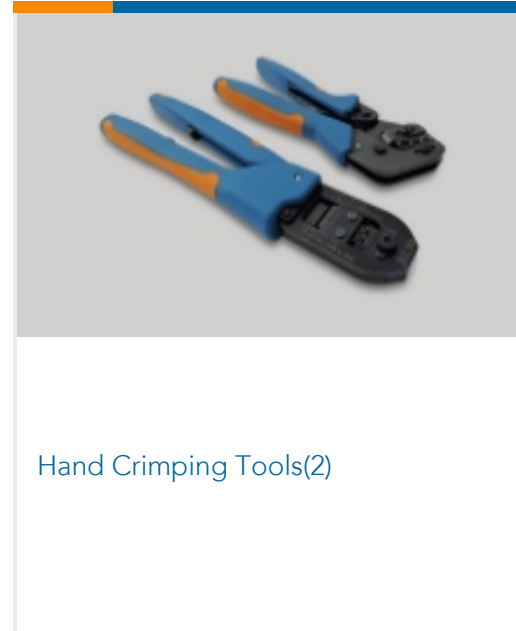
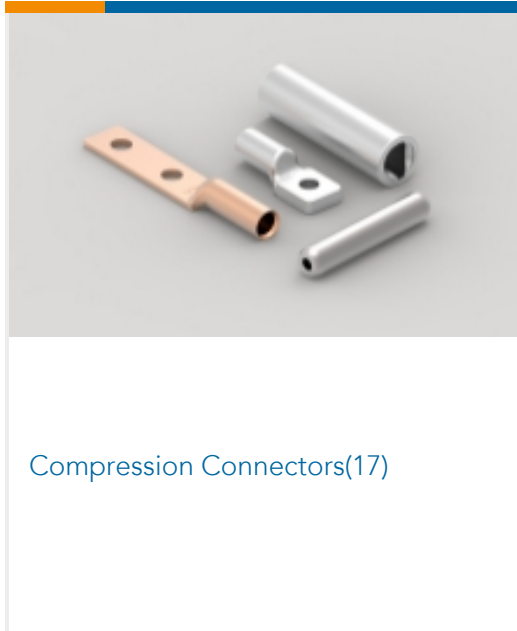

## Customers Also Bought

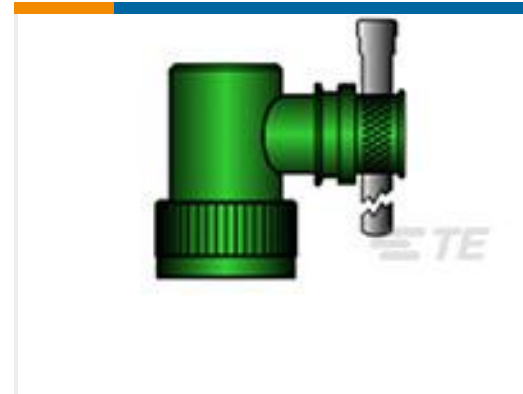

TE Part #109026-31  
CONT PINTE Part #EF8626-000  
R85049/90-19Z03TE Part #400-4301-8S  
SZ 8 LOCATOR

## Documents

### Product Drawings

TERMINAL,PIDG PVF2 R 12-10 1/4

English

### CAD Files

Customer View Model

[ENG\\_CVM\\_53426-1\\_L1.3d\\_igs.zip](#)

English

Customer View Model

[ENG\\_CVM\\_53426-1\\_L1.3d\\_stp.zip](#)

English

Customer View Model

[ENG\\_CVM\\_53426-1\\_L1.2d\\_dxf.zip](#)

English

### 3D PDF

English

By downloading the CAD file I accept and agree to the [Terms and Conditions](#) of use.