

Final datasheet

Soft and ultra-fast recovery 1200 V Emitter controlled 7 diode for both Industrial and Home Appliance applications

Features

- $V_{RRM} = 1200\text{ V}$
- $I_F = 120\text{ A}$
- 1200 V emitter controlled technology
- Maximum junction temperature $T_{vjmax} = 175^\circ\text{C}$
- Low forward voltage (V_F)
- Low reverse recovery charge
- Ultrafast recovery times
- Soft recovery characteristics
- Pb-free lead plating; RoHS compliant
- Humidity robust design

Potential applications

- String inverter
- EV-Charging
- Heat pump

Product validation

- Qualified for industrial applications according to the relevant tests of JEDEC47/20/22



- Green
- Halogen-free
- Lead-free
- RoHS

Description

Pin definition:

- Pin 1 and backside - Cathode
- Pin 2 - Anode

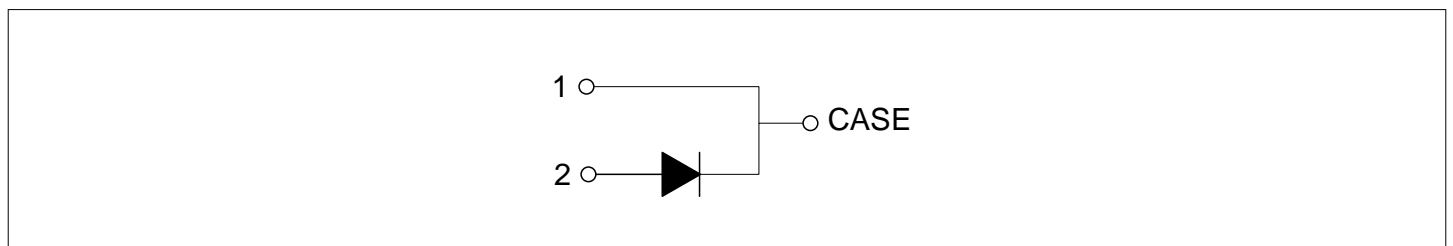

Type	Package	Marking
IDWD120E120D7	PG-TO247-2-STD-NA8.8	E120MD7

Table of contents

	Description	1
	Features	1
	Potential applications	1
	Product validation	1
	Table of contents	2
1	Package	3
2	Diode	3
3	Characteristics diagrams	7
4	Package outlines	9
5	Testing conditions	10
	Revision history	11
	Disclaimer	12

1 Package

Table 1 Characteristic values

Parameter	Symbol	Note or test condition	Values			Unit
			Min.	Typ.	Max.	
Internal emitter inductance measured 5 mm (0.197 in.) from case	L_E			13		nH
Storage temperature	T_{stg}		-55		150	°C
Soldering temperature	T_{sold}	wave soldering 1.6 mm (0.063 in.) from case for 10 s			260	°C
Mounting torque	M	M3 screw, Maximum of mounting processes: 3			0.6	Nm
Thermal resistance, junction-ambient	$R_{th(j-a)}$				40	K/W
Diode thermal resistance, junction-case	$R_{th(j-c)}$			0.24	0.31	K/W

2 Diode

Table 2 Maximum rated values

Parameter	Symbol	Note or test condition		Values	Unit
Repetitive peak reverse voltage	V_{RRM}	$T_{vj} \geq 25 \text{ °C}$		1200	V
Diode forward current, limited by T_{vjmax}	I_F		$T_c = 25 \text{ °C}$	177	A
			$T_c = 91 \text{ °C}$	120	
Diode pulsed current, t_p limited by T_{vjmax}	I_{Fpulse}			480	A
Diode surge non repetitive forward current, sine halfwave	I_{FSM}	$t_p = 10 \text{ ms}$	$T_c = 25 \text{ °C}$	420	A
Diode surge repetitive forward current, sine halfwave ¹⁾	I_{FRM}	$t_p = 10 \text{ ms}$	$T_c = 25 \text{ °C}$	360	A
Power dissipation	P_{tot}		$T_c = 25 \text{ °C}$	478	W
			$T_c = 100 \text{ °C}$	239	

1) Not subject to production test. The test was performed with 20k pulses (half-wave rectified sine with 10 ms period).

Table 3 Characteristic values

Parameter	Symbol	Note or test condition	Values			Unit	
			Min.	Typ.	Max.		
Diode forward voltage	V_F	$I_F = 120 \text{ A}$	$T_{vj} = 25 \text{ }^\circ\text{C}$		2.5	3	V
			$T_{vj} = 150 \text{ }^\circ\text{C}$		2.35		
			$T_{vj} = 175 \text{ }^\circ\text{C}$		2.3		
Reverse leakage current	I_R	$V_R = 1200 \text{ V}$	$T_{vj} = 25 \text{ }^\circ\text{C}$			20	μA
			$T_{vj} = 175 \text{ }^\circ\text{C}$		2200		
Diode reverse recovery time	t_{rr}	$V_R = 800 \text{ V}$	$T_{vj} = 25 \text{ }^\circ\text{C}$, $I_F = 120 \text{ A}$, $-di_F/dt = 1000 \text{ A}/\mu\text{s}$		215		ns
			$T_{vj} = 25 \text{ }^\circ\text{C}$, $I_F = 60 \text{ A}$, $-di_F/dt = 1000 \text{ A}/\mu\text{s}$		190		
			$T_{vj} = 175 \text{ }^\circ\text{C}$, $I_F = 120 \text{ A}$, $-di_F/dt = 1000 \text{ A}/\mu\text{s}$		230		
			$T_{vj} = 175 \text{ }^\circ\text{C}$, $I_F = 60 \text{ A}$, $-di_F/dt = 1000 \text{ A}/\mu\text{s}$		205		
Diode reverse recovery charge	Q_{rr}	$V_R = 800 \text{ V}$	$T_{vj} = 25 \text{ }^\circ\text{C}$, $I_F = 120 \text{ A}$, $-di_F/dt = 1000 \text{ A}/\mu\text{s}$		2.7		μC
			$T_{vj} = 25 \text{ }^\circ\text{C}$, $I_F = 60 \text{ A}$, $-di_F/dt = 1000 \text{ A}/\mu\text{s}$		2.05		
			$T_{vj} = 175 \text{ }^\circ\text{C}$, $I_F = 120 \text{ A}$, $-di_F/dt = 1000 \text{ A}/\mu\text{s}$		6.05		
			$T_{vj} = 175 \text{ }^\circ\text{C}$, $I_F = 60 \text{ A}$, $-di_F/dt = 1000 \text{ A}/\mu\text{s}$		4.55		

(table continues...)

Table 3 (continued) Characteristic values

Parameter	Symbol	Note or test condition	Values			Unit	
			Min.	Typ.	Max.		
Diode peak reverse recovery current	I_{rrm}	$V_R = 800\text{ V}$	$T_{vj} = 25\text{ °C}$, $I_F = 120\text{ A}$, $-di_F/dt = 1000\text{ A}/\mu\text{s}$		25		A
			$T_{vj} = 25\text{ °C}$, $I_F = 60\text{ A}$, $-di_F/dt = 1000\text{ A}/\mu\text{s}$		23		
			$T_{vj} = 175\text{ °C}$, $I_F = 120\text{ A}$, $-di_F/dt = 1000\text{ A}/\mu\text{s}$		42		
			$T_{vj} = 175\text{ °C}$, $I_F = 60\text{ A}$, $-di_F/dt = 1000\text{ A}/\mu\text{s}$		40		
Diode peak rate of fall of reverse recovery current	di_{rr}/dt	$V_R = 800\text{ V}$	$T_{vj} = 25\text{ °C}$, $I_F = 120\text{ A}$, $-di_F/dt = 1000\text{ A}/\mu\text{s}$		120		A/ μs
			$T_{vj} = 25\text{ °C}$, $I_F = 60\text{ A}$, $-di_F/dt = 1000\text{ A}/\mu\text{s}$		140		
			$T_{vj} = 175\text{ °C}$, $I_F = 120\text{ A}$, $-di_F/dt = 1000\text{ A}/\mu\text{s}$		185		
			$T_{vj} = 175\text{ °C}$, $I_F = 60\text{ A}$, $-di_F/dt = 1000\text{ A}/\mu\text{s}$		240		
Reverse recovery energy	E_{rec}	$V_R = 800\text{ V}$	$T_{vj} = 25\text{ °C}$, $I_F = 120\text{ A}$, $-di_F/dt = 1000\text{ A}/\mu\text{s}$		0.75		mJ
			$T_{vj} = 25\text{ °C}$, $I_F = 60\text{ A}$, $-di_F/dt = 1000\text{ A}/\mu\text{s}$		0.6		
			$T_{vj} = 175\text{ °C}$, $I_F = 120\text{ A}$, $-di_F/dt = 1000\text{ A}/\mu\text{s}$		1.75		
			$T_{vj} = 175\text{ °C}$, $I_F = 60\text{ A}$, $-di_F/dt = 1000\text{ A}/\mu\text{s}$		1.3		
Operating junction temperature	T_{vj}		-40		175	°C	

Note: *For optimum lifetime and reliability, Infineon recommends operating conditions that do not exceed 80% of the maximum ratings stated in this datasheet.*

Electrical Characteristic at $T_{vj} = 25^{\circ}\text{C}$, unless otherwise specified.

Dynamic test circuit, parasitic inductance $L_{\sigma} = 27 \text{ nH}$, parasitic capacitor $C_{\sigma} = 12 \text{ pF}$ from Fig. E, IKY140N120CH7 was used as IGBT.

3 Characteristics diagrams

Diode transient thermal impedance as a function of pulse width

$$Z_{th(j-c)} = f(t_p)$$

$$D = t_p/T$$

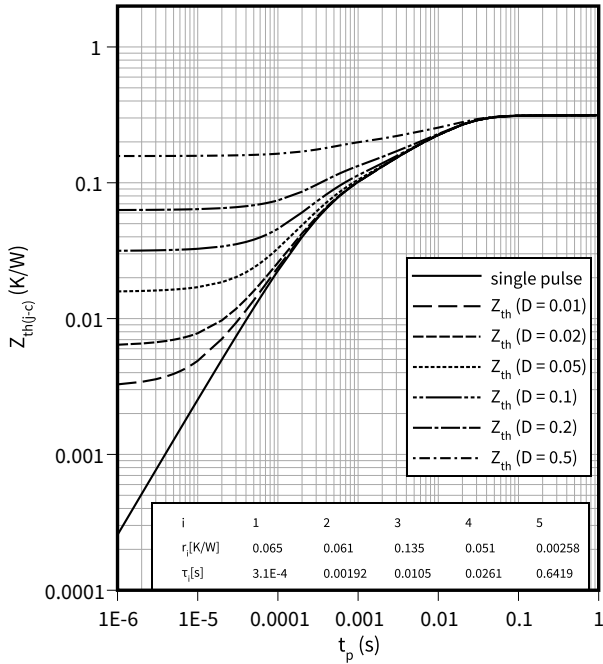

Typical diode forward current as a function of forward voltage

$$I_F = f(V_F)$$

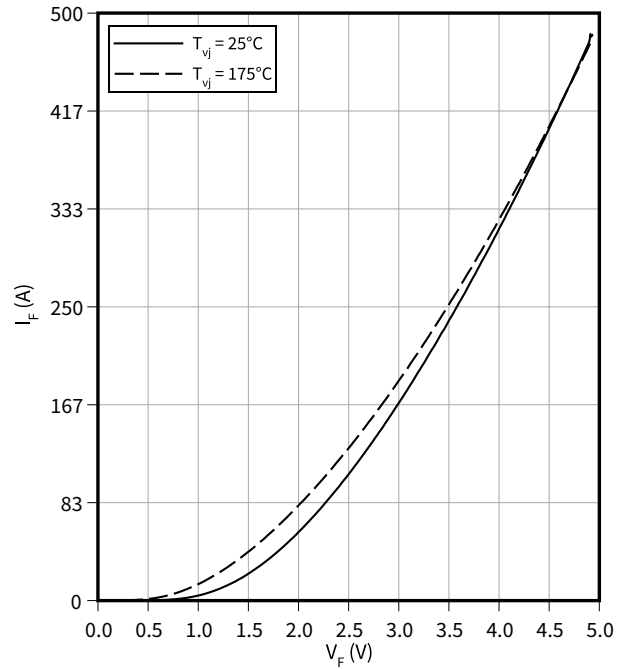

Typical diode forward voltage as a function of junction temperature

$$V_F = f(T_{vj})$$

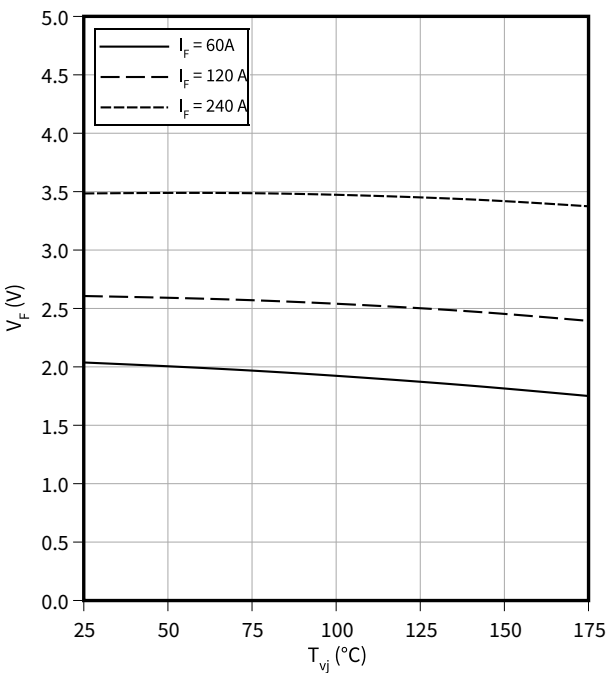

Typical reverse recovery time as a function of diode current slope

$$t_{rr} = f(di_F/dt)$$

$$V_R = 800 \text{ V}, I_F = 120 \text{ A}$$

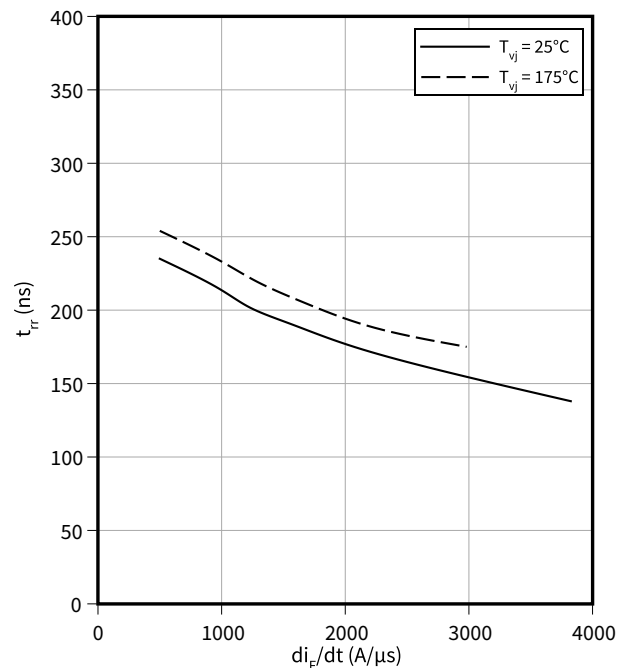

3 Characteristics diagrams

Typical reverse recovery charge as a function of diode current slope

$Q_{rr} = f(di_F/dt)$

$V_R = 800\text{ V}, I_F = 120\text{ A}$

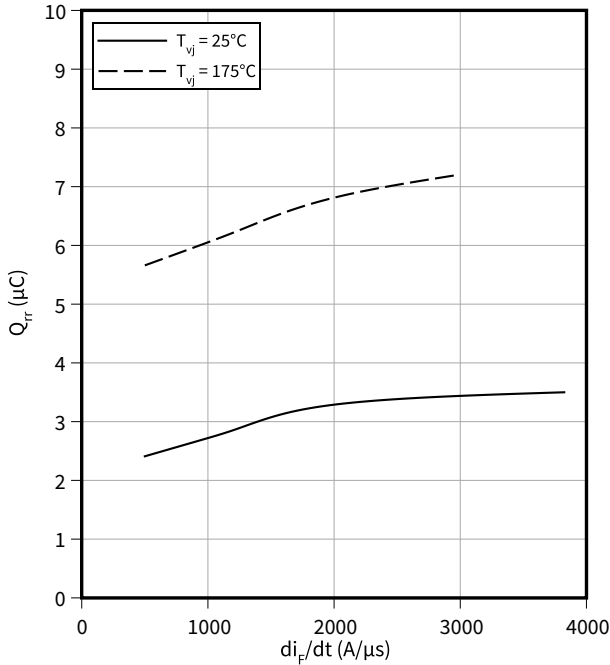

Typical reverse recovery current as a function of diode current slope

$I_{rrm} = f(di_F/dt)$

$V_R = 800\text{ V}, I_F = 120\text{ A}$

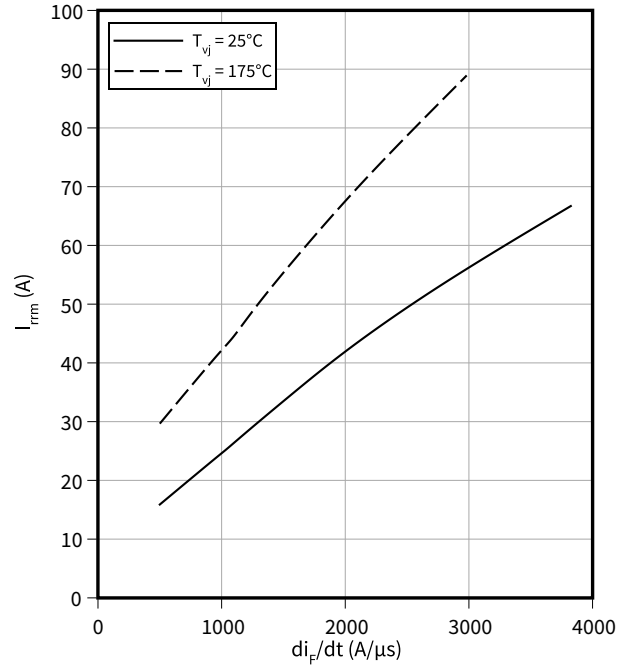

Typical diode peak rate of fall of reverse recovery current as a function of diode current slope

$di_{rr}/dt = f(di_F/dt)$

$V_R = 800\text{ V}, I_F = 120\text{ A}$

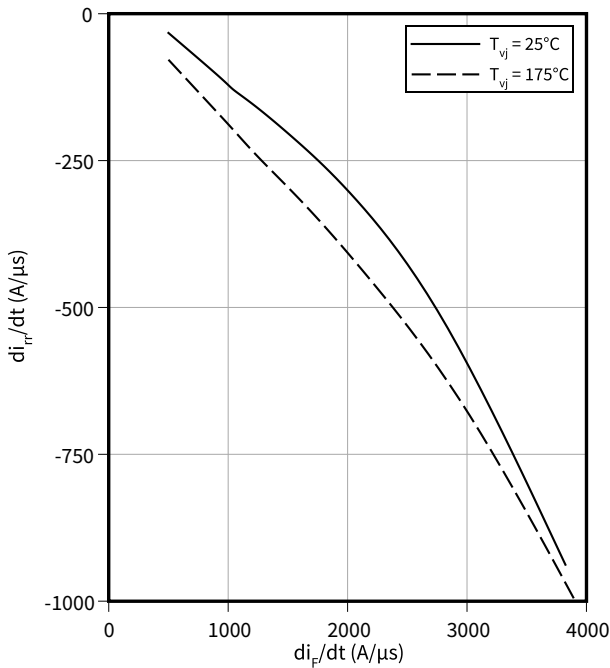

Typical reverse energy losses as a function of diode current slope

$E_{rec} = f(di_F/dt)$

$V_R = 800\text{ V}, I_F = 120\text{ A}$

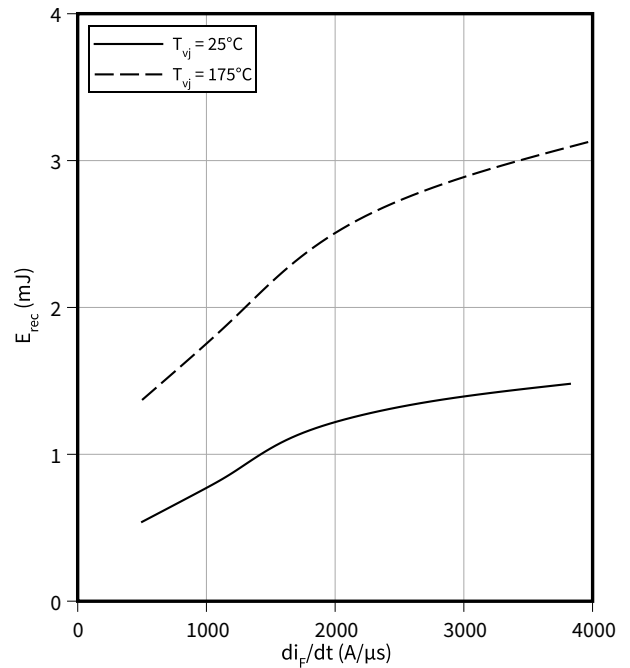

4 Package outlines

PG-TO247-2-STD-NA8.8

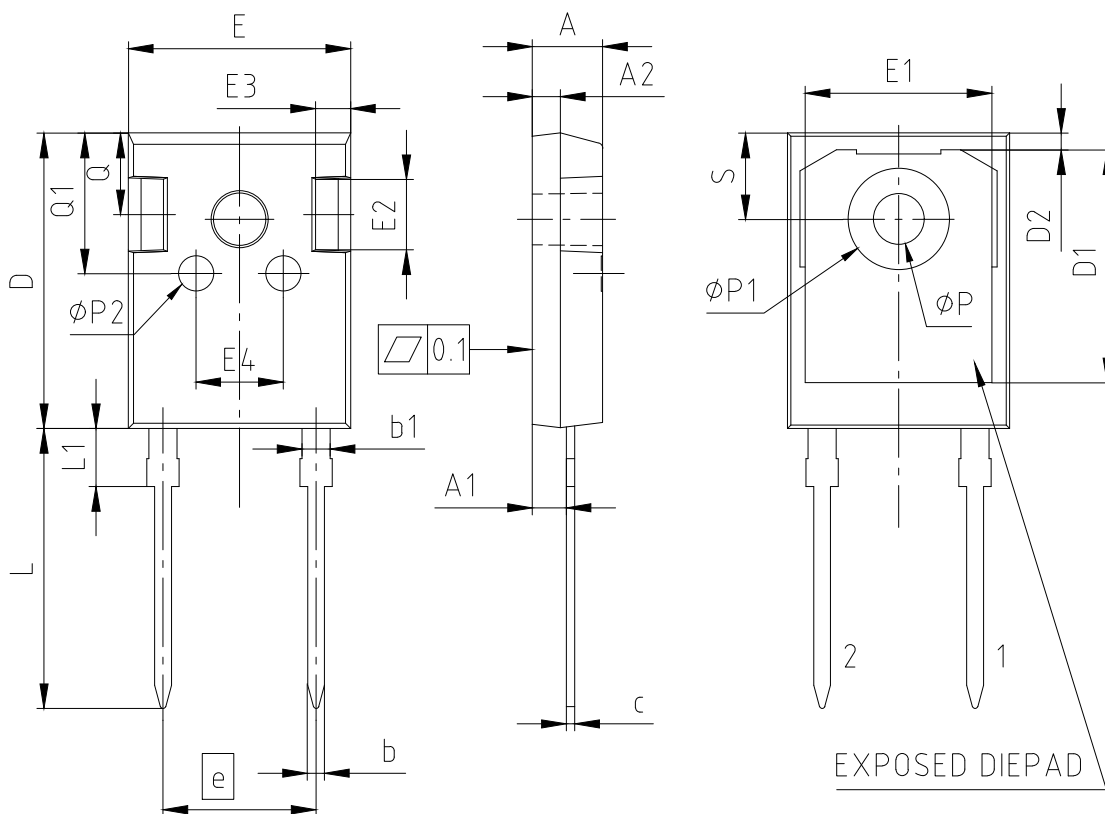

PACKAGE - GROUP NUMBER:		PG-TO247-2-U01			
DIMENSIONS	MILLIMETERS				
	MIN.	MAX.			
A	4.90	5.10	L	19.80	20.10
A1	2.31	2.51	L1	---	4.30
A2	1.90	2.10	øP	3.50	3.70
b	1.16	1.26	øP1	7.00	7.40
b1	1.96	2.06	øP2	2.40	2.60
c	0.59	0.66	Q	5.60	6.00
D	20.90	21.10	Q1	9.80	10.20
D1	16.25	16.85	S	6.05	6.25
D2	1.05	1.35			
E	15.70	15.90			
E1	13.10	13.50			
E2	4.90	5.10			
E3	2.40	2.60			
E4	6.00	6.40			
e	10.88				
N	2				

ALL DIMENSIONS DO NOT INCLUDE MOLD FLASH OR PROTRUSIONS.

Figure 1

5 Testing conditions

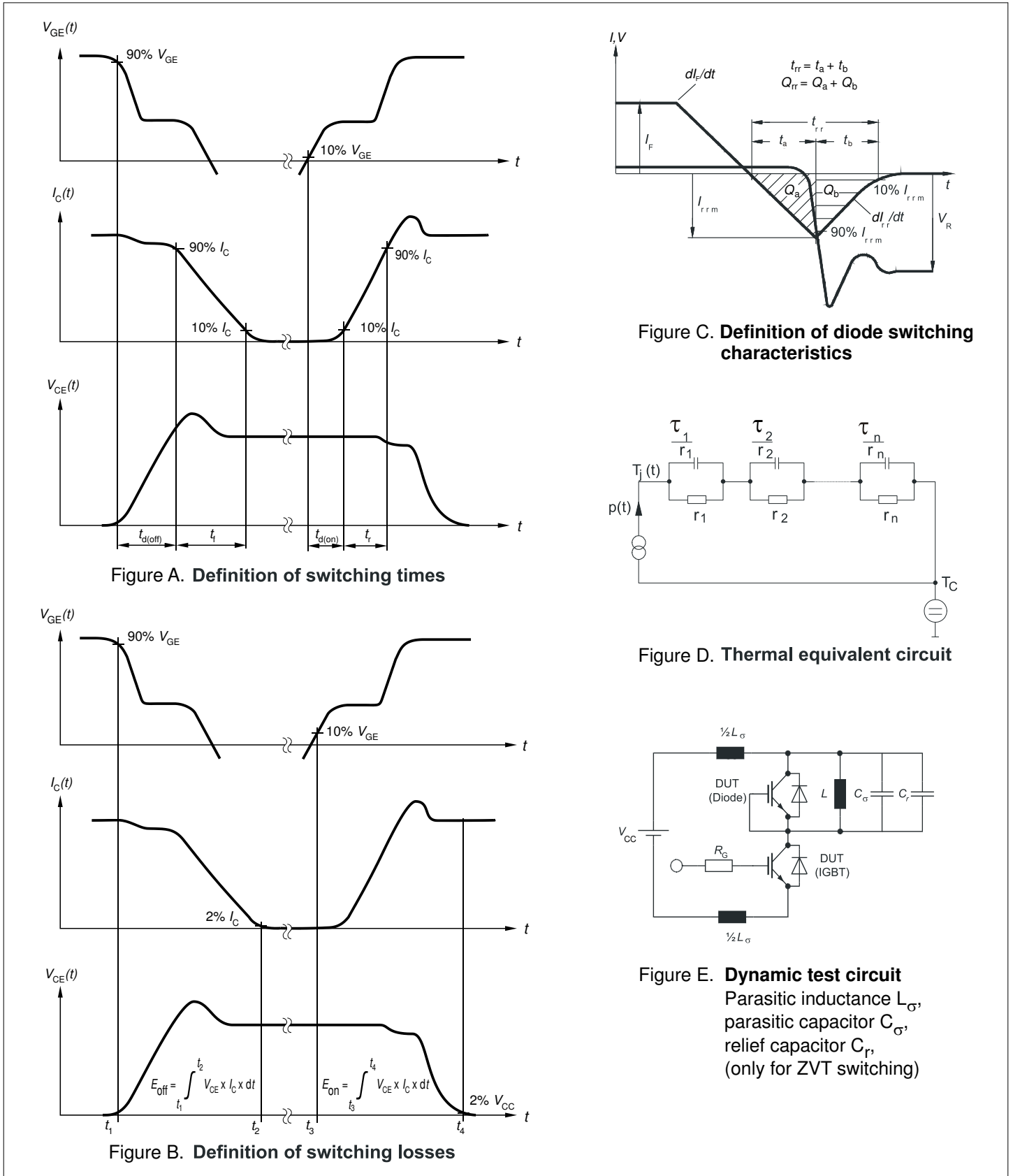

Figure 2

Revision history

Document revision	Date of release	Description of changes
1.00	2023-12-15	Final datasheet

Trademarks

All referenced product or service names and trademarks are the property of their respective owners.

Edition 2023-12-15

Published by

Infineon Technologies AG

81726 Munich, Germany

© 2023 Infineon Technologies AG

All Rights Reserved.

Do you have a question about any aspect of this document?

Email: erratum@infineon.com

Document reference

IFX-ABJ032-001

Important notice

The information given in this document shall in no event be regarded as a guarantee of conditions or characteristics ("Beschaffheitsgarantie").

With respect to any examples, hints or any typical values stated herein and/or any information regarding the application of the product, Infineon Technologies hereby disclaims any and all warranties and liabilities of any kind, including without limitation warranties of non-infringement of intellectual property rights of any third party.

In addition, any information given in this document is subject to customer's compliance with its obligations stated in this document and any applicable legal requirements, norms and standards concerning customer's products and any use of the product of Infineon Technologies in customer's applications.

The data contained in this document is exclusively intended for technically trained staff. It is the responsibility of customer's technical departments to evaluate the suitability of the product for the intended application and the completeness of the product information given in this document with respect to such application.

Please note that this product is not qualified according to the AEC Q100 or AEC Q101 documents of the Automotive Electronics Council.

Warnings

Due to technical requirements products may contain dangerous substances. For information on the types in question please contact your nearest Infineon Technologies office.

Except as otherwise explicitly approved by Infineon Technologies in a written document signed by authorized representatives of Infineon Technologies, Infineon Technologies' products may not be used in any applications where a failure of the product or any consequences of the use thereof can reasonably be expected to result in personal injury.