

### General Description

The SY8492 develops a high efficiency, current mode adaptive constant OFF time controlled, asynchronous step-down DC/DC converter capable of delivering 2A output current. The SY8492 operates over a wide input voltage range from 4.5V to 60V and integrates main switch with very low  $R_{DS(ON)}$  to minimize the conduction loss. The switching frequency is adjustable from 100kHz to 1MHz using an external resistor. And the device features cycle-by-cycle peak current limitation.

### Ordering Information

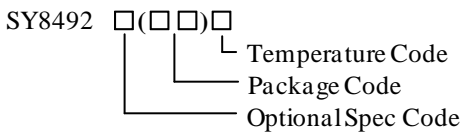

Ordering Number	Package type	Note
SY8492FCC	SO8E	--

### Features

- Low  $R_{DS(ON)}$  for Internal N-channel Power FET (TOP):175m $\Omega$
- 4.5-60V Input Voltage Range
- 2A Output Current Capability
- Adjustable Switching Frequency Range: 100kHz to 1MHz
- Internal Soft-start Limits the Inrush Current
- Hic-cup Mode Output Short Circuit Protection
- EN ON/OFF Control with Accurate Threshold
- Cycle-by-cycle Peak Current Limit
- 0.8V $\pm$  1% Reference Voltage Accuracy
- Compact Package: SO8E

### Applications

- Non-isolated Telecommunication Buck Regulator
- Secondary High Voltage Post Regulator
- Automotive Systems
- Electric Bicycle

### Typical Applications

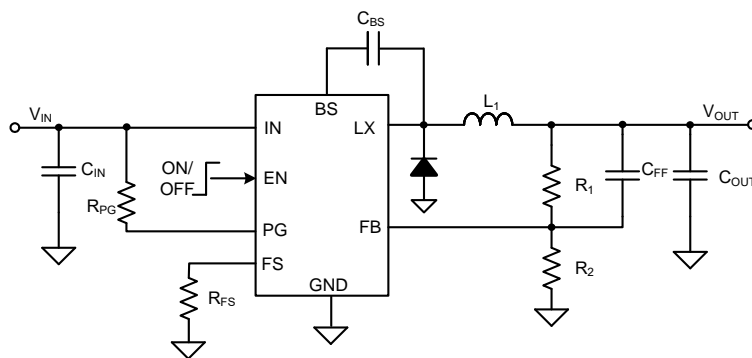

Figure1. Schematic Diagram

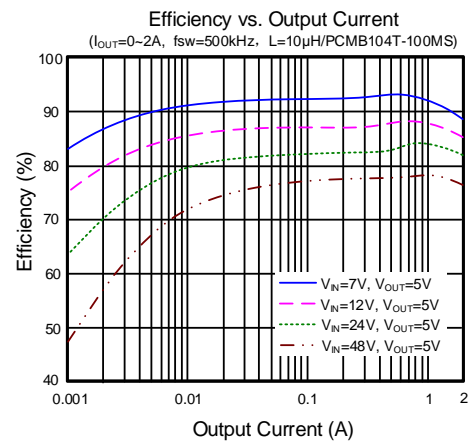
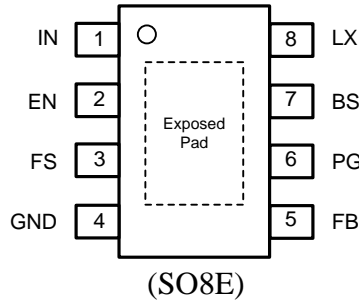

Figure2. Efficiency vs. Output Current

**Pinout (top view)**



Top Mark: CALxyz (Device code: CAL; x=year code, y=week code, z=lot number code)

Pin Name	Pin Number	Pin Description
IN	1	Input pin. Decouple this pin to the GND pin with at least a 1μF ceramic capacitor.
EN	2	Enable control. Pulled high to turn on. Do not leave it floating.
FS	3	Frequency programming pin. Connect a resistor to ground to program a switching frequency between 100kHz to 1MHz. The switching frequency equals to: $f_{sw}(kHz)=10^5/R_{FS}(k\Omega)$
GND	4	Ground pin.
FB	5	Output feedback pin. Connect this pin to the center point of the output resistor divider (as shown in Figure 1) to program the output voltage: $V_{OUT}=0.8 \times (1+R_1/R_2)$ .
PG	6	Power good indicator. Open-drain output when the output voltage is within 90% to 120% of the regulation point.
BS	7	Boot-strap pin. Supply high side gate driver. Connect a 0.1μF ceramic capacitor between the BS pin and the LX pin.
LX	8	Inductor pin. Connect this pin to the switching node of the inductor.
Exposed Pad	/	Exposed pad must be connected to the GND pin. Connected to system ground plane on application board for optimal thermal performance.

**Block Diagram**

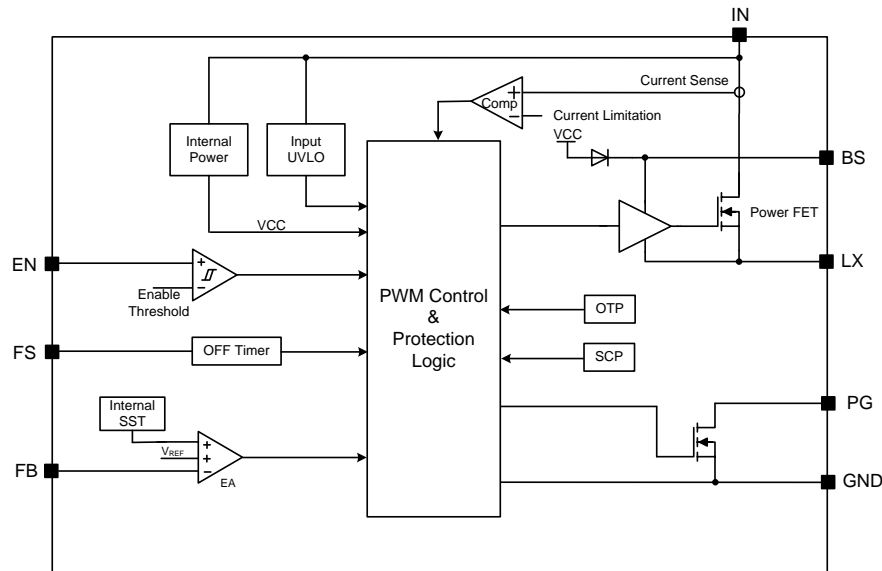

**Figure3. Block Diagram**



**Absolute Maximum Ratings** (Note 1)

Supply Input Voltage -----	-0.3V to 66V
BS-LX Voltage -----	-0.3V to 6V
EN, FS, FB, PG, LX Voltage -----	-0.3V to $V_{IN} + 0.3V$
Power Dissipation, $P_D$ @ $T_A = 25^\circ C$ , SO8E -----	3.3W
Package Thermal Resistance (Note 2)	
$\theta_{JA}$ -----	38°C/W
$\theta_{JC}$ -----	3°C/W
Junction Temperature Range -----	-40°C to 150°C
Lead Temperature (Soldering, 10 sec.) -----	260°C
Storage Temperature Range -----	-65°C to 150°C
Dynamic LX voltage in 10 ns Duration -----	$V_{IN} + 3V$ to GND-5V

**Recommended Operating Conditions** (Note 3)

Supply Input Voltage -----	4.5V to 60V
Junction Temperature Range -----	-40°C to 125°C
Ambient Temperature Range -----	-40°C to 85°C

## Electrical Characteristics

( $V_{IN}=24V$ ,  $V_{OUT}=5V$ ,  $L=10\mu H$ ,  $C_{OUT}=22\mu F$ ,  $T_A=25^\circ C$ ,  $I_{OUT}=1A$  unless otherwise specified)

Parameter	Symbol	Test Conditions	Min	Typ	Max	Unit
Input Voltage Range	$V_{IN}$		4.5		60	V
Input UVLO Threshold	$V_{UVLO}$		3.9	4.2	4.5	V
Input UVLO Hysteresis	$V_{HYS}$			0.3		V
Quiescent Current	$I_Q$	$V_{FB}=V_{REF}\times 105\%$		100	130	$\mu A$
Shutdown Current	$I_{SHDN}$	$V_{EN}=0V$		6	16	$\mu A$
Feedback Reference Voltage	$V_{REF}$		792	800	808	mV
FB Input Current	$I_{FB}$	$V_{FB}=3.3V$	-50		50	nA
Top FET $R_{ON}$	$R_{DS(ON)}$			175		m $\Omega$
EN Rising Threshold	$V_{EN,R}$		1	1.1	1.2	V
EN Falling Threshold	$V_{EN,F}$		0.8	0.9	1	V
Min ON Time	$t_{ON,MIN}$			130		ns
Min OFF Time	$t_{OFF,MIN}$			200		ns
Soft-start Time	$t_{SS}$			2		ms
Switching Frequency Program Range	$f_{SW,RNG}$	$R_{FS}=100k\sim 1M$	100		1000	kHz
Switching Frequency Setting Accuracy	$f_{SW}$	$R_{OSC}=200k$	400	500	600	kHz
Power Good Threshold	$V_{PG}$	$V_{FB}$ falling, PG from high to low		90		% $V_{REF}$
		$V_{FB}$ rising, PG from low to high		92		% $V_{REF}$
		$V_{FB}$ rising, PG from high to low		120		% $V_{REF}$
		$V_{FB}$ falling, PG from low to high		115		% $V_{REF}$
Power Good Delay	$t_{PG,F}$	High to low		20		$\mu s$
	$t_{PG,R}$	Low to high		200		$\mu s$
Power Good Output Low	$V_{PG,L}$	$I_{PG}=2mA$			0.3	V
PG High Leakage Current					1	$\mu A$
Top FET Current Limit	$I_{LMT,RNG}$		2.8	3.5	4.2	A
Output Under Voltage Protection Threshold	$V_{UVP}$		45	50	55	% $V_{REF}$
Output UVP Delay	$t_{UVP,DLY}$			10		$\mu s$
UVP Hic-cup ON Time	$t_{UVP,ON}$			2		ms
UVP Hic-cup OFF Time	$t_{UVP,OFF}$			16		ms
Thermal Shutdown Temperature	$T_{SD}$			150		$^\circ C$
Thermal Shutdown Hysteresis	$T_{HYS}$			15		$^\circ C$

**Note 1:** Stresses beyond “Absolute Maximum Ratings” may cause permanent damage to the device. These are for stress ratings. Functional operation of the device at these or any other conditions beyond those indicated in the operational sections of the specifications is not implied. Exposure to absolute maximum rating conditions may affect device reliability.

**Note 2:**  $\theta_{JA}$  is measured in the natural convection at  $T_A=25^\circ C$  on a high effective thermal conductivity four-layer test board per JESD51-7. Pin 2 of SO8E packages is the case position for  $\theta_{JC}$  measurement.

**Note 3:** The device is not guaranteed to function outside its operating conditions.

# Typical Performance Characteristics

( $f_{sw}=500kHz$ ,  $T_A=25^\circ C$ )

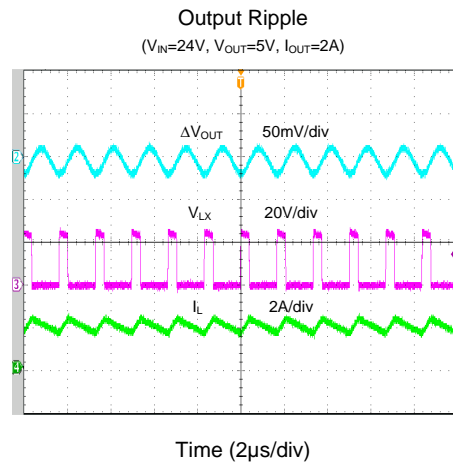
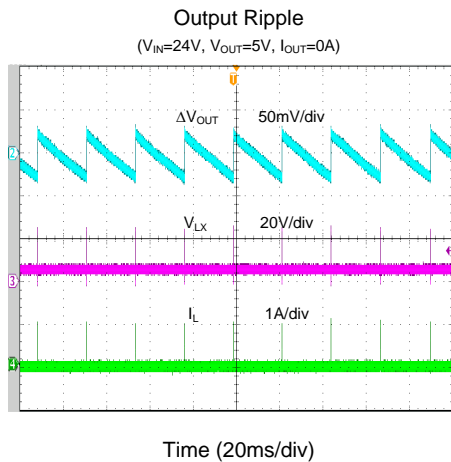
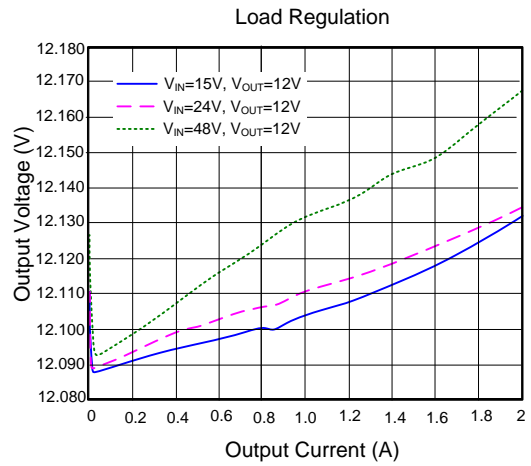
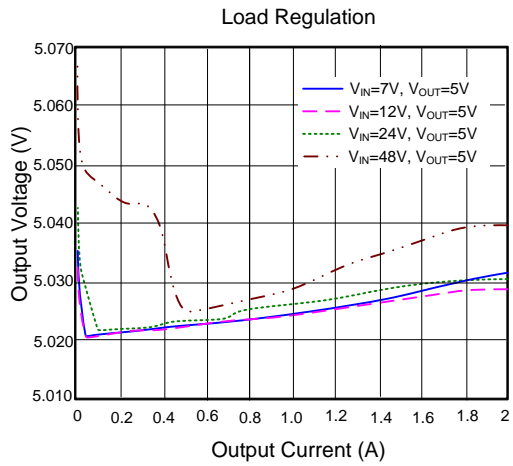
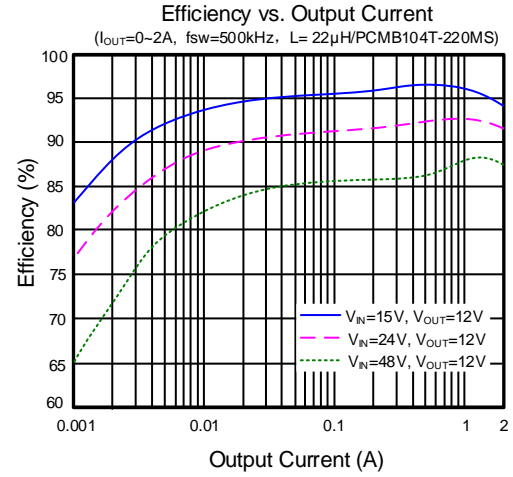
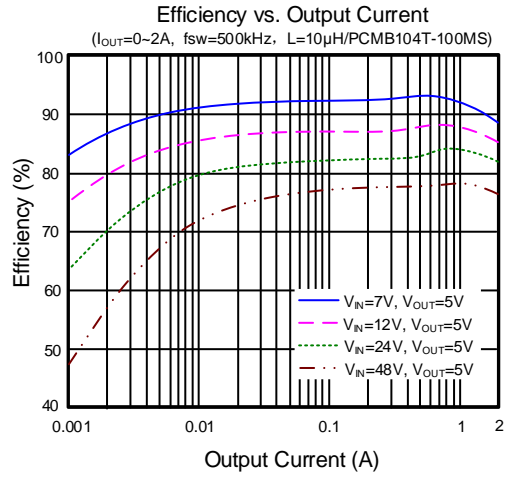

Startup from  $V_{IN}$   
( $V_{IN}=24V$ ,  $V_{OUT}=5V$ ,  $I_{OUT}=0A$ )

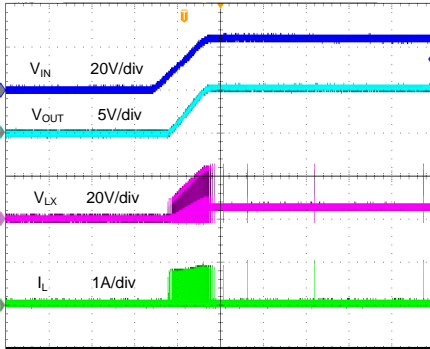

Time (2ms/div)

Shutdown from  $V_{IN}$   
( $V_{IN}=24V$ ,  $V_{OUT}=5V$ ,  $I_{OUT}=0A$ )

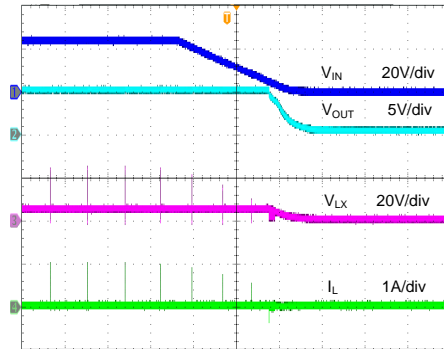

Time (20ms/div)

Startup from  $V_{IN}$   
( $V_{IN}=24V$ ,  $V_{OUT}=5V$ ,  $I_{OUT}=2A$ )

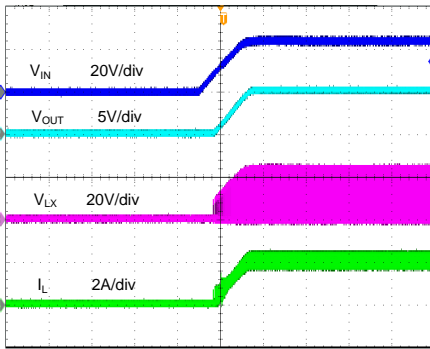

Time (2ms/div)

Shutdown from  $V_{IN}$   
( $V_{IN}=24V$ ,  $V_{OUT}=5V$ ,  $I_{OUT}=2A$ )

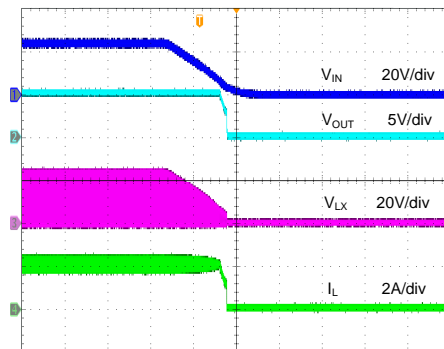

Time (20ms/div)

Startup from Enable  
( $V_{IN}=24V$ ,  $V_{OUT}=5V$ ,  $I_{OUT}=0A$ )

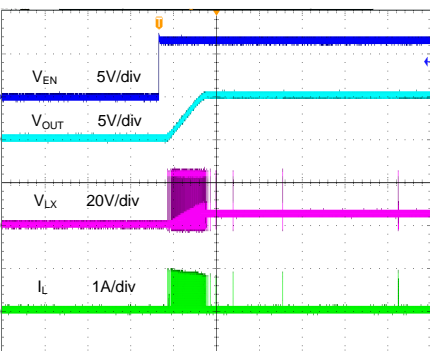

Time (2ms/div)

Shutdown from Enable  
( $V_{IN}=24V$ ,  $V_{OUT}=5V$ ,  $I_{OUT}=0A$ )

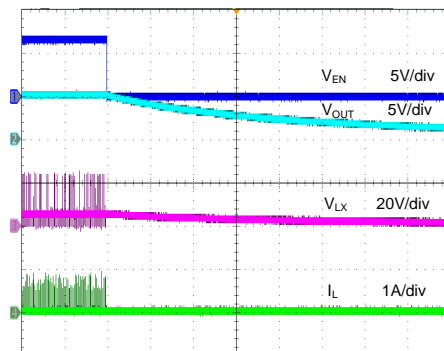

Time (1s/div)

**Startup from Enable**  
( $V_{IN}=24V$ ,  $V_{OUT}=5V$ ,  $I_{OUT}=2A$ )

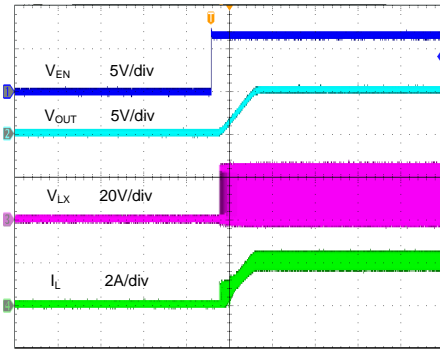

Time (2ms/div)

**Shutdown from Enable**  
( $V_{IN}=24V$ ,  $V_{OUT}=5V$ ,  $I_{OUT}=2A$ )

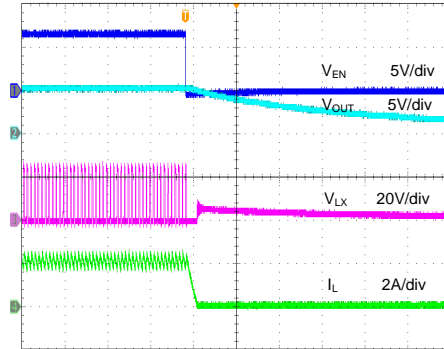

Time (20 $\mu$ s/div)

**Short Circuit Protection**  
( $V_{IN}=24V$ ,  $V_{OUT}=5V$ ,  $I_{OUT}=0A$  - Short)

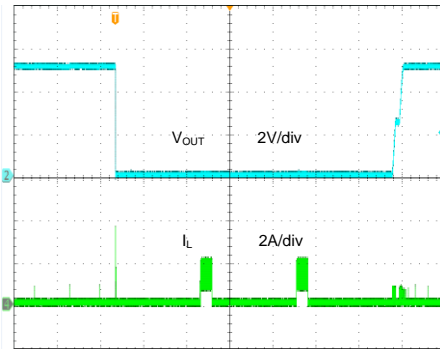

Time (10ms/div)

**Short Circuit Protection**  
( $V_{IN}=24V$ ,  $V_{OUT}=5V$ ,  $I_{OUT}=2A$  - Short)

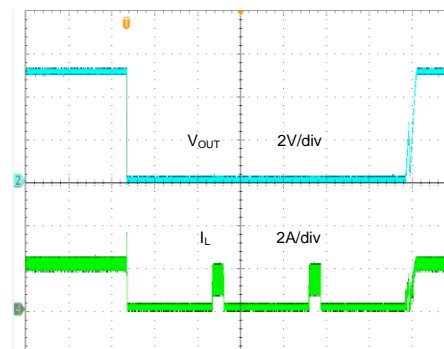

Time (10ms/div)

**Load transient**  
( $V_{IN}=24V$ ,  $V_{OUT}=5V$ ,  $I_{OUT}=0.2A$  - 2A)

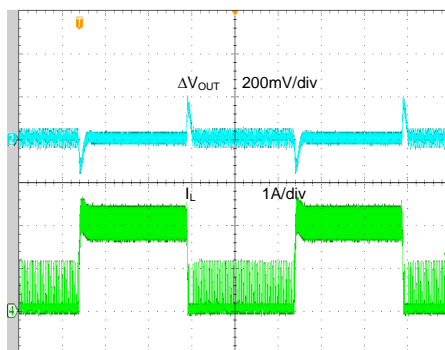

Time (200 $\mu$ s/div)

## Operation

The SY8492 is a high efficiency asynchronous step down DC/DC regulator capable of delivering 2A output current. The device adopts current mode adaptive constant OFF time control. The SY8492 operates over a wide input voltage range from 4.5V to 60V and integrates main switch with very low  $R_{DS(ON)}$  to minimize the conduction loss.

The switching frequency is adjustable from 100kHz to 1MHz using an external resistor. And the device features cycle-by-cycle peak current limitation.

## Applications Information

Because of the high integration in the SY8492, the application circuit based on this IC is rather simple. Only the input capacitor  $C_{IN}$ , the output capacitor  $C_{OUT}$ , the output inductor  $L_1$  and the feedback resistors ( $R_1$  and  $R_2$ ) need to be selected for the target applications.

### Feedback Resistor Dividers $R_1$ and $R_2$ :

Choose  $R_1$  and  $R_2$  to program the proper output voltage. To minimize the power consumption under light load, it is desirable to choose large resistance values for both  $R_1$  and  $R_2$ . A value of between 10k $\Omega$  and 1M $\Omega$  is highly recommended for both resistors. If  $V_{OUT}$  is 5V,  $R_1=105k\Omega$  is chosen, then using the following equation,  $R_2$  can be calculated to be 20k $\Omega$ :

$$R_2 = \frac{V_{FB}}{V_{OUT} - V_{FB}} R_1, \quad V_{FB} \text{ is typical } 0.8V.$$

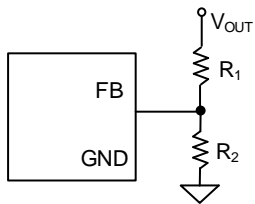

### Input Capacitor $C_{IN}$ :

The ripple current through the input capacitor is calculated as:

$$I_{CIN, RMS} = I_{OUT} \times \sqrt{D(1-D)}$$

To minimize the potential noise problem, a typical X5R or better grade ceramic capacitor should be placed really close to the IN and the GND pins. Care should be taken to minimize the loop area formed by  $C_{IN}$ , and the IN/GND pins. In this case, a 1 $\mu$ F low ESR ceramic capacitor is recommended.

### Output Capacitor $C_{OUT}$ :

The output capacitor is selected to handle the output ripple noise requirements. Both steady state ripple and transient requirements must be taken into consideration when selecting this capacitor. For the best performance, it is recommended to use an X5R or better grade ceramic capacitor greater than 22 $\mu$ F capacitance.

### Output Inductor $L$ :

There are several considerations in choosing this inductor.

- 1) Choose the inductance to provide the desired ripple current. It is suggested to choose the ripple current to be about 40% of the maximum output current. The inductance is calculated as:

$$L = \frac{V_{OUT}(1 - V_{OUT}/V_{IN,MAX})}{f_{SW} \times I_{OUT,MAX} \times 40\%}$$

Where  $f_{sw}$  is the switching frequency and the  $I_{OUT,MAX}$  is the maximum load current.

The SY8492 regulator is quite tolerant of different ripple current amplitude. Consequently, the final choice of inductance can be slightly off the calculation value without significantly impacting the performance.

- 2) The saturation current rating of the inductor must be selected to be greater than the peak inductor current under full load conditions.

$$I_{SAT, MIN} > I_{OUT, MAX} + \frac{V_{OUT}(1 - V_{OUT}/V_{IN,MAX})}{2 \times f_{SW} \times L}$$

- 3) The DCR of the inductor and the core loss at the switching frequency must be low enough to achieve the desired efficiency requirement. It is desirable to choose an inductor with  $DCR < 50m\Omega$  to achieve a good overall efficiency.

### Enable Operation

Pulling the EN pin low (<0.8V) will shut down the device. During the shutdown mode, the SY8492 shutdown current will drop to lower than 6 $\mu$ A(typ.). Driving the EN pin high (>1.2V) will turn on the IC again.

It is not recommended to connect EN and IN directly. A resistor in a range of 10k $\Omega$  to 1M $\Omega$  should be used if EN is pulled high by IN.

### External Bootstrap Capacitor

This capacitor provides the gate driver voltage for internal high side MOSFET. A 100nF low ESR ceramic capacitor connected between the BS pin and the LX pin is recommended.

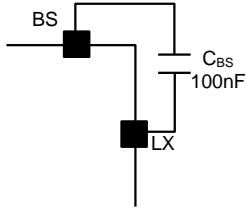

### Adjustable Switching Frequency:

The FS pin is used for setting the switching frequency of the device by connecting a resistor from the FS pin to GND. The switching frequency of the device is adjustable from 100 kHz to 1MHz.

$$f_{sw}(\text{kHz}) = 10^5 / R_{FS}(\text{k}\Omega)$$

The SY8492 linearly folds back the switching frequency when the FB voltage is within 0~50% of the reference voltage during soft-start and the SCP event. The minimum switching frequency is clamped to 50kHz.

### Power Good Indication

PG is an open-drain output pin. This pin will be pulled to ground if the output voltage is lower than 90% of regulation voltage or higher than 120% of regulation voltage. Otherwise this pin will go to a high impedance state.

### Over-current Protection (OCP)

The SY8492 features cycle-by-cycle peak current limit. When the peak current limit is triggered, the device will turn off the high side MOSFET and turn on the low side MOSFET until the next cycle clock is coming.

### Short-circuit Protection (SCP)

If  $V_{OUT} < 50\%$  of the set-point continuously for approximately  $10\mu\text{s}$ , the short-circuit protection mode will be initiated, and the device will shut down for 8 soft-start time. The device will then restart with a complete soft-start cycle. If the short circuit condition remains, another ‘hiccup’ cycle of shutdown and restart will continue indefinitely.

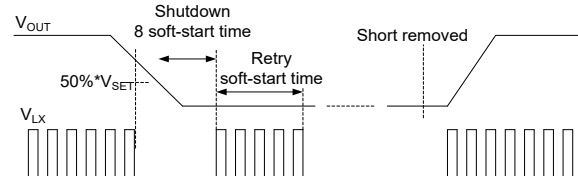

### Over-temperature Protection (OTP)

The device includes over-temperature protection (OTP) circuitry to prevent overheating due to excessive power dissipation. This will shut down switching operation when the junction temperature exceeds  $150^\circ\text{C}$ . Once the junction temperature cools down by approximately  $15^\circ\text{C}$  the IC will resume normal operation after a complete soft-start cycle. For continuous operation, provide adequate cooling so that the junction temperature does not exceed the OTP threshold.

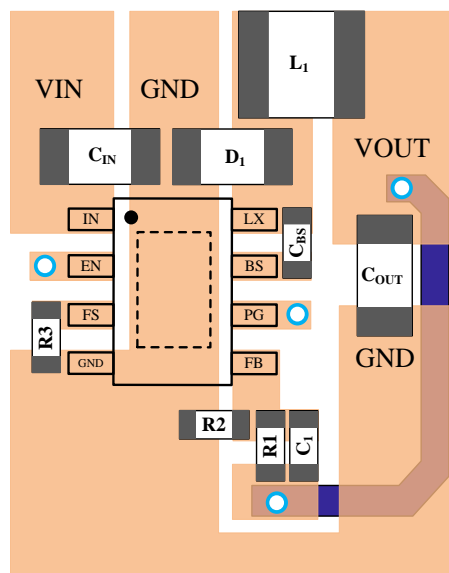
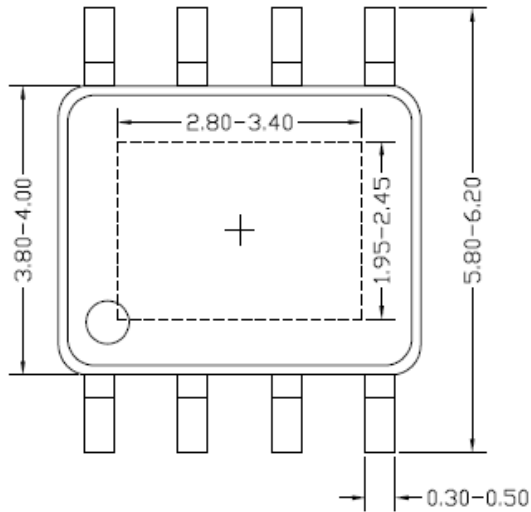
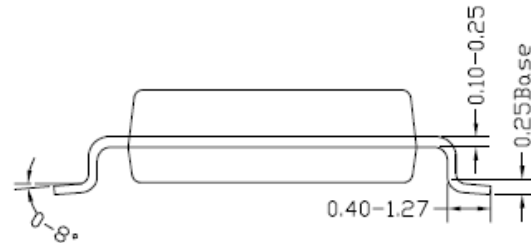

Figure4. PCB Layout Suggestion

**SO8E Package Outline & PCB Layout**



**Top view**



**Side view**

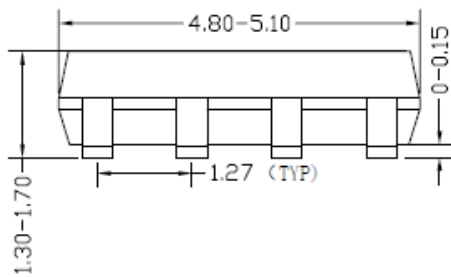

**Front view**

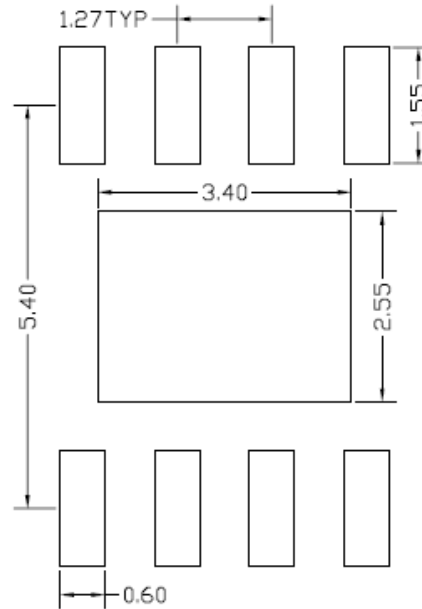

**Recommended PCB layout  
(Reference Only)**

**Notes: All dimension in millimeter and exclude mold flash & metal burr.**

## Taping & Reel Specification

### 1. Taping orientation SO8E

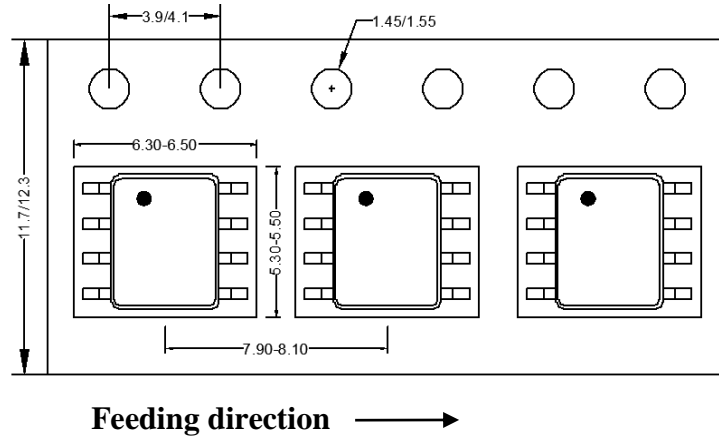

### 2. Carrier Tape & Reel specification for packages

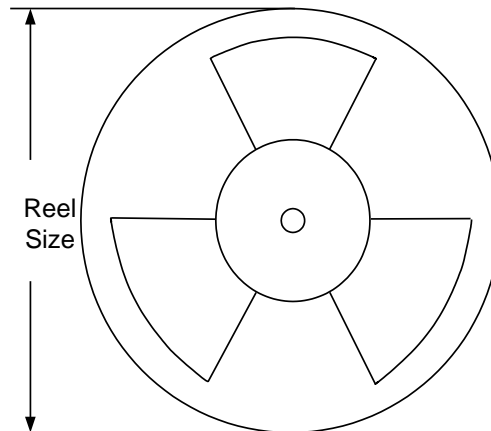

Package types	Tape width (mm)	Pocket pitch(mm)	Reel size (Inch)	Trailer * length(mm)	Leader * length (mm)	Qty per reel (pcs)
SO8E	12	8	13"	400	400	2500

**Others: NA**

### IMPORTANT NOTICE

1. **Right to make changes.** Silergy and its subsidiaries (hereafter Silergy) reserve the right to change any information published in this document, including but not limited to circuitry, specification and/or product design, manufacturing or descriptions, at any time and without notice. This document supersedes and replaces all information supplied prior to the publication hereof. Buyers should obtain the latest relevant information before placing orders and should verify that such information is current and complete. All semiconductor products are sold subject to Silergy's standard terms and conditions of sale.
2. **Applications.** Application examples that are described herein for any of these products are for illustrative purposes only. Silergy makes no representation or warranty that such applications will be suitable for the specified use without further testing or modification. Buyers are responsible for the design and operation of their applications and products using Silergy products. Silergy or its subsidiaries assume no liability for any application assistance or designs of customer products. It is customer's sole responsibility to determine whether the Silergy product is suitable and fit for the customer's applications and products planned. To minimize the risks associated with customer's products and applications, customer should provide adequate design and operating safeguards. Customer represents and agrees that it has all the necessary expertise to create and implement safeguards which anticipate dangerous consequences of failures, monitor failures and their consequences, lessen the likelihood of failures that might cause harm and take appropriate remedial actions. Silergy assumes no liability related to any default, damage, costs or problem in the customer's applications or products, or the application or use by customer's third-party buyers. Customer will fully indemnify Silergy, its subsidiaries, and their representatives against any damages arising out of the use of any Silergy components in safety-critical applications. It is also buyers' sole responsibility to warrant and guarantee that any intellectual property rights of a third party are not infringed upon when integrating Silergy products into any application. Silergy assumes no responsibility for any said applications or for any use of any circuitry other than circuitry entirely embodied in a Silergy product.
3. **Limited warranty and liability.** Information furnished by Silergy in this document is believed to be accurate and reliable. However, Silergy makes no representation or warranty, expressed or implied, as to the accuracy or completeness of such information and shall have no liability for the consequences of use of such information. In no event shall Silergy be liable for any indirect, incidental, punitive, special or consequential damages, including but not limited to lost profits, lost savings, business interruption, costs related to the removal or replacement of any products or rework charges, whether or not such damages are based on tort or negligence, warranty, breach of contract or any other legal theory. Notwithstanding any damages that customer might incur for any reason whatsoever, Silergy' aggregate and cumulative liability towards customer for the products described herein shall be limited in accordance with the Standard Terms and Conditions of Sale of Silergy.
4. **Suitability for use.** Customer acknowledges and agrees that it is solely responsible for compliance with all legal, regulatory and safety-related requirements concerning its products, and any use of Silergy components in its applications, notwithstanding any applications-related information or support that may be provided by Silergy. Silergy products are not designed, authorized or warranted to be suitable for use in life support, life-critical or safety-critical systems or equipment, nor in applications where failure or malfunction of an Silergy product can reasonably be expected to result in personal injury, death or severe property or environmental damage. Silergy assumes no liability for inclusion and/or use of Silergy products in such equipment or applications and therefore such inclusion and/or use is at the customer's own risk.
5. **Terms and conditions of commercial sale.** Silergy products are sold subject to the standard terms and conditions of commercial sale, as published at <http://www.silergy.com/stdterms>, unless otherwise agreed in a valid written individual agreement specifically agreed to in writing by an authorized officer of Silergy. In case an individual agreement is concluded only the terms and conditions of the respective agreement shall apply. Silergy hereby expressly objects to and denies the application of any customer's general terms and conditions with regard to the purchase of Silergy products by the customer.
6. **No offer to sell or license.** Nothing in this document may be interpreted or construed as an offer to sell products that is open for acceptance or the grant, conveyance or implication of any license under any copyrights, patents or other industrial or intellectual property rights. Silergy makes no representation or warranty that any license, either express or implied, is granted under any patent right, copyright, mask work right, or other intellectual property right. Information published by Silergy regarding third-party products or services does not constitute a license to use such products or services or a warranty or endorsement thereof. Use of such information may require a license from a third party under the patents or other intellectual property of the third party, or a license from Silergy under the patents or other intellectual property of Silergy.

For more information, please visit: [www.silergy.com](http://www.silergy.com)

© 2021 Silergy Corp.

All Rights Reserved.