

SPECIFICATIONS

Current Rating: 1.5 Amps
 Insulation Resistance: 1000M Ω Min
 Contact Resistance: 20m Ω Max
 Withstanding Voltage: AC 500V
 Operation Temperature: -40° to +105°
 Contact Material: Brass
 Standard: PA6T
 Insulator Material: Polyester (UL 94V-0)
 Contact Plating: Gold Flash
 Max. Processing Temp: 240° C for 30-60 seconds
 (260° C for 5 seconds)

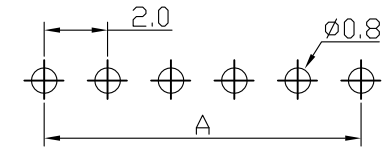

RECOMMEND P. C. B LAYOUT
 PCB TOLERANCE: ± 0.05 (TOP VIEW)

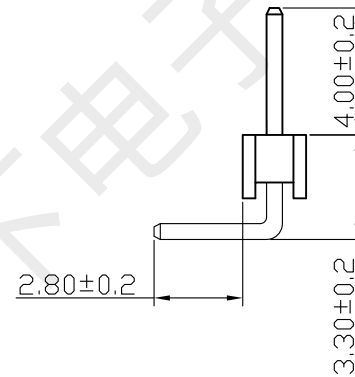
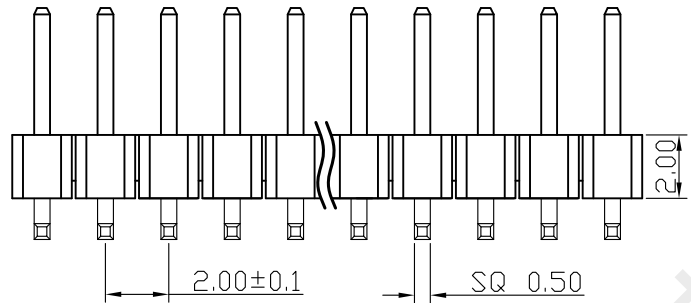
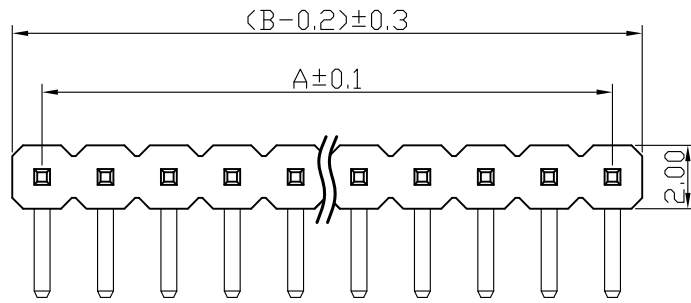

深圳市韩下电子有限公司

UNLESS OTHERWISE SPECIFIED TOLERANCE

X : ± 0.30 X° : $\pm 5^\circ$
 X.X : ± 0.25 X.X° : $\pm 1^\circ$
 X.XX : ± 0.20 X.XX° : $\pm 0.5^\circ$

DRAWN NAME:

HX PZ2.0-1x4P WZ-AM

SIZE	A4	SCALE	N:1	PROUCT NO.
REV	A	UNIT	mm	PROJECT
				PAGE 1/1

DRAWN: 黄彬 2022/04/24 CHECKED: 张伟 2022/04/24 APPROVED: 罗小春 2022/04/24

No. of	DIM. A	DIM. B	No. of	DIM. A	DIM. B	No. of	DIM. A	DIM. B	No. of	DIM. A	DIM. B
1	0.00	2.00	11	20.00	22.00	21	40.00	42.00	31	60.00	62.00
2	2.00	4.00	12	22.00	24.00	22	42.00	44.00	32	62.00	64.00
3	4.00	6.00	13	24.00	26.00	23	44.00	46.00	33	64.00	66.00
4	6.00	8.00	14	26.00	28.00	24	46.00	48.00	34	66.00	68.00
5	8.00	10.00	15	28.00	30.00	25	48.00	50.00	35	68.00	70.00
6	10.00	12.00	16	30.00	32.00	26	50.00	52.00	36	70.00	72.00
7	12.00	14.00	17	32.00	34.00	27	52.00	54.00	37	72.00	74.00
8	14.00	16.00	18	34.00	36.00	28	54.00	56.00	38	74.00	76.00
9	16.00	18.00	19	36.00	38.00	29	56.00	58.00	39	76.00	78.00
10	18.00	20.00	20	38.00	40.00	30	58.00	60.00	40	78.00	80.00