



Features:

- 2G / 3G / 4G MiMo
- Global LTE Bands:
 - B1-B23, B25-B29, B33-B42
 - N.A.; Europe, Asia (incl. Jap.)
- GNSS (GPS, Glonass)
- Single device
 - Guaranteed Port-to-Port Isolation
- Foldable for tight spaces

Applications:

- Challenging RF Environments Demanding:
 - Highest Peak Gain
 - Lowest ECC (Envelope Correlation Coeff.).
- Matched to Radio Modules from:
 - Sierra Wireless, Telit, Huawei, Gemalto, uBlox, ZTE, and others.
- Security, Video, Graphics
- IoT, SmartGrid, Meters, Remote Monitoring, Sensor Networks
- Transportation, Tracking

All dimensions are in mm / inches

Issue: 2435

In the effort to improve our products, we reserve the right to make changes judged to be necessary.

CONFIDENTIAL AND PROPRIETARY INFORMATION

This document contains confidential and proprietary information of Pulse Electronics, Inc. (Pulse) and is protected by copyright, trade secret and other state and federal laws. Its receipt or possession does not convey any rights to reproduce, disclose its contents, or to manufacture, use or sell anything it may describe. Reproduction, disclosure or use without specific written authorization of Pulse is strictly forbidden.

For more information:

Pulse Worldwide Headquarters
12220 World Trade Drive
San Diego, CA 92128
USA
Tel: 1-858-674-8100

Pulse/Larsen Antennas
18110 SE 34th St Bldg 2 Suite 250
Vancouver, WA 98683
USA
Tel: 1-360-944-7551

Europe Headquarters
Pulse GmbH & Do, KG
Zeppelinstrasse 15
Herrenberg, Germany
Tel: 49 7032 7806 0

Pulse (Suzhou) Wireless Products Co, Inc.
99 Huo Ju Road(#29 Bldg, 4th Phase
Suzhou New District
Jiangsu Province, Suzhou 215009 PR China
Tel: 86 512 6807 9998



ELECTRICAL SPECIFICATIONS

LTE1 & LTE2 :

Frequency	698-960/1427.9-1510.9/1559-1610/ 1695-2200/2300-2700/3400-3600 MHz
Nominal Impedance	50Ω
Return loss(698-960MHz)	-6dB
Return loss(1427.9-1510.9/1559-1610/ 1695-2200/2300-2700/3400-3600MHz)	-7.5dB
Isolation(698-960MHz)	-10dB
Isolation(1427.9-1510.9/1559-1610/ 1695-2200/2300-2700/3400-3600MHz)	-13dB
Average Total Efficiency (698-960MHz)	55%
Average Total Efficiency (1427.9-1510.9MHz)	60%
Average Total Efficiency (1559-1610MHz)	60%
Average Total Efficiency (1695-2200MHz)	65%
Average Total Efficiency (2300-2700MHz)	70%
Average Total Efficiency (3400-3600MHz)	65%

ELECTRICAL SPECIFICATIONS

Peak Gain (698-960MHz)	2.9dBi
Peak Gain (1427.9-1510.9MHz)	1.7dBi
Peak Gain (1559-1610MHz)	1.8dBi
Peak Gain (1695-2200MHz)	3.4dBi
Peak Gain (2300-2700MHz)	3.8dBi
Peak Gain (3400-3600MHz)	4.2dBi

GNSS :

Frequency	1570-1610MHz
Nominal Impedance	50Ω
Return loss (1570-1610MHz)	-10dB
Average Total Efficiency (1570-1610MHz)	35%
Peak Gain (1570-1610MHz)	0.8dBi
Radiation Pattern	Omni
Polarization	Linear
Power withstanding	3W
Connector type	U.FL compatible
Cable type	Low loss Φ1.13mm Coaxial Cable

(*) All RF parameters measured on 2mm thick PC plate

Description: 2x2 MIMO LTE + GNSS FPC
ANTENNA

Series: Internal Antenna

PART NUMBER: W6113XXXXX

MECHANICAL SPECIFICATIONS

Color	Black
Weight	4.0 g
Cable type	OD 1.13mm coax cable
Cable length	300mm
Connector	U.FL compatible
Fixing system	Adhesive 3M467

ENVIRONMENTAL SPECIFICATIONS

Operating temperature	-40/+85 ° C
-----------------------	-------------

Issue: 2435

In the effort to improve our products, we reserve the right to make changes judged to be necessary.

CONFIDENTIAL AND PROPRIETARY INFORMATION

This document contains confidential and proprietary information of Pulse Electronics, Inc. (Pulse) and is protected by copyright, trade secret and other state and federal laws. Its receipt or possession does not convey any rights to reproduce, disclose its contents, or to manufacture, use or sell anything it may describe. Reproduction, disclosure or use without specific written authorization of Pulse is strictly forbidden.

MECHANICAL DRAWING

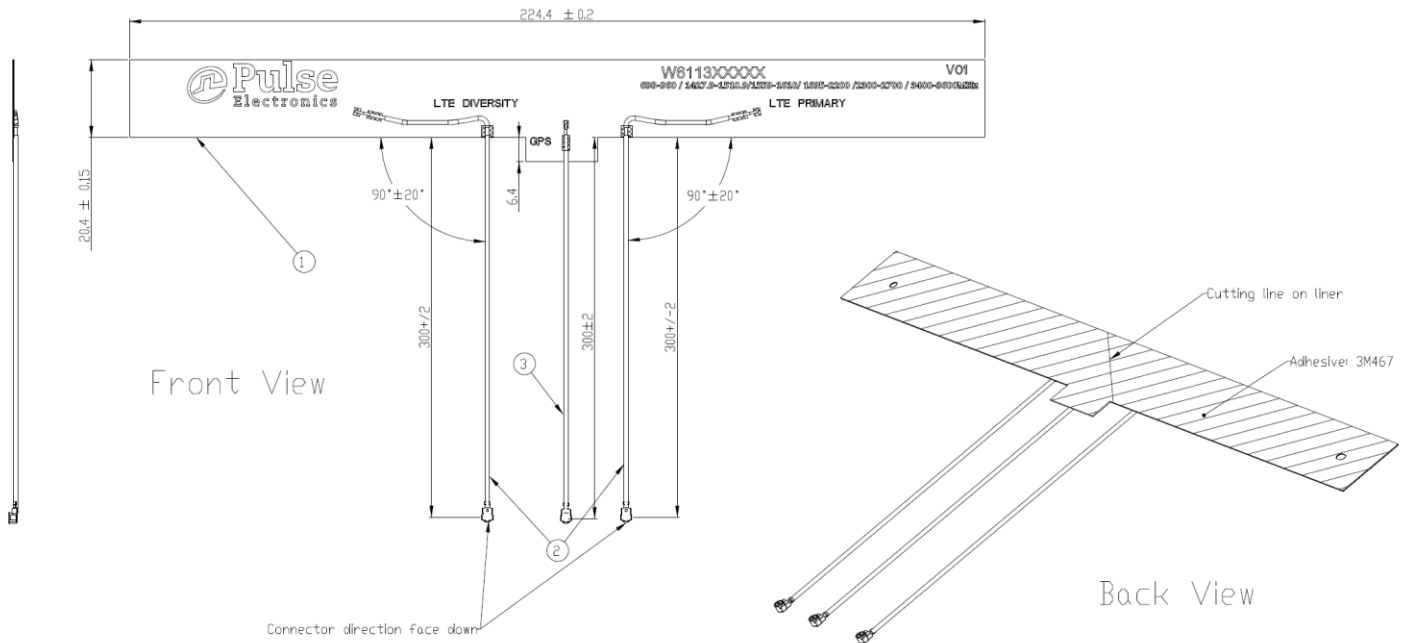

Item	Part Number	Cable length "A" (mm/inch)
1	W6113B0100	100/3.94
2	W6113B0130	130/5.12
3	W6113B0300	300/11.81

CHARTS

Return Loss [dB]

LTE1 & LTE2 Return Loss

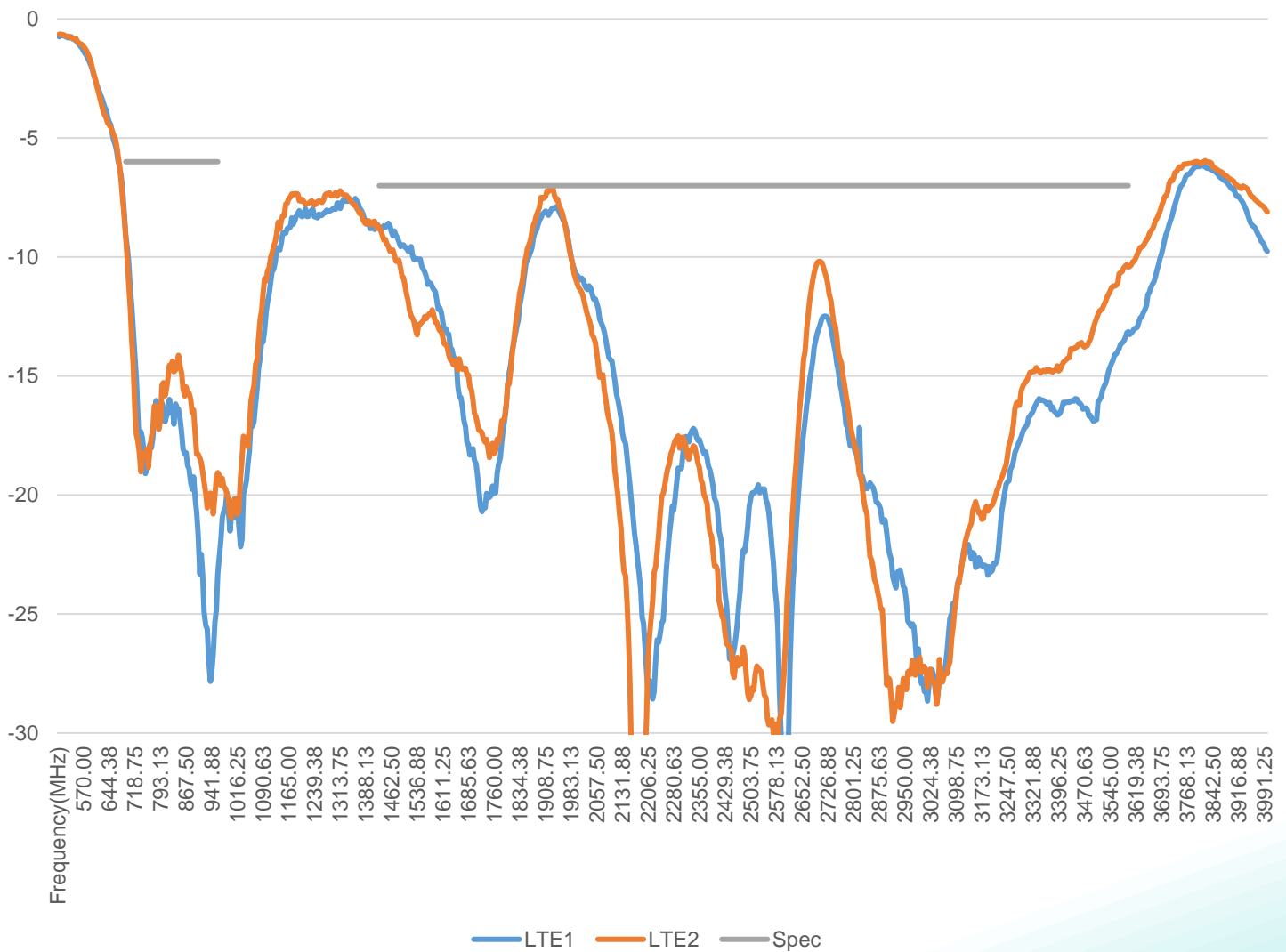

Note : All test results measured with 300mm cable length

Issue: 2435

In the effort to improve our products, we reserve the right to make changes judged to be necessary.

CONFIDENTIAL AND PROPRIETARY INFORMATION

This document contains confidential and proprietary information of Pulse Electronics, Inc. (Pulse) and is protected by copyright, trade secret and other state and federal laws. Its receipt or possession does not convey any rights to reproduce, disclose its contents, or to manufacture, use or sell anything it may describe. Reproduction, disclosure or use without specific written authorization of Pulse is strictly forbidden.

CHARTS

Return Loss [dB]

GNSS Return Loss

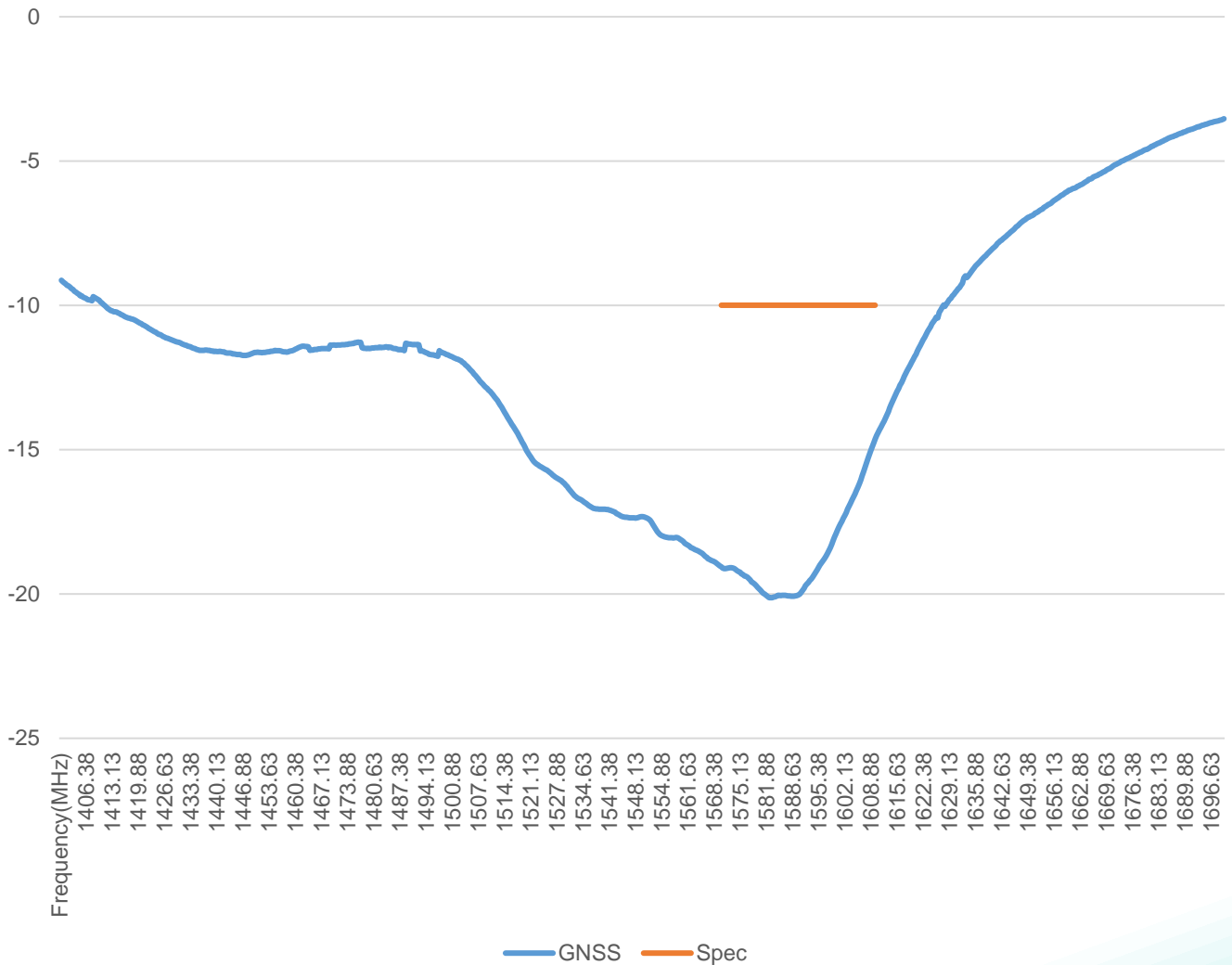

Note : All test results measured with 300mm cable length

Issue: 2435

In the effort to improve our products, we reserve the right to make changes judged to be necessary.

CONFIDENTIAL AND PROPRIETARY INFORMATION

This document contains confidential and proprietary information of Pulse Electronics, Inc. (Pulse) and is protected by copyright, trade secret and other state and federal laws. Its receipt or possession does not convey any rights to reproduce, disclose its contents, or to manufacture, use or sell anything it may describe. Reproduction, disclosure or use without specific written authorization of Pulse is strictly forbidden.

CHARTS

Isolation [dB]

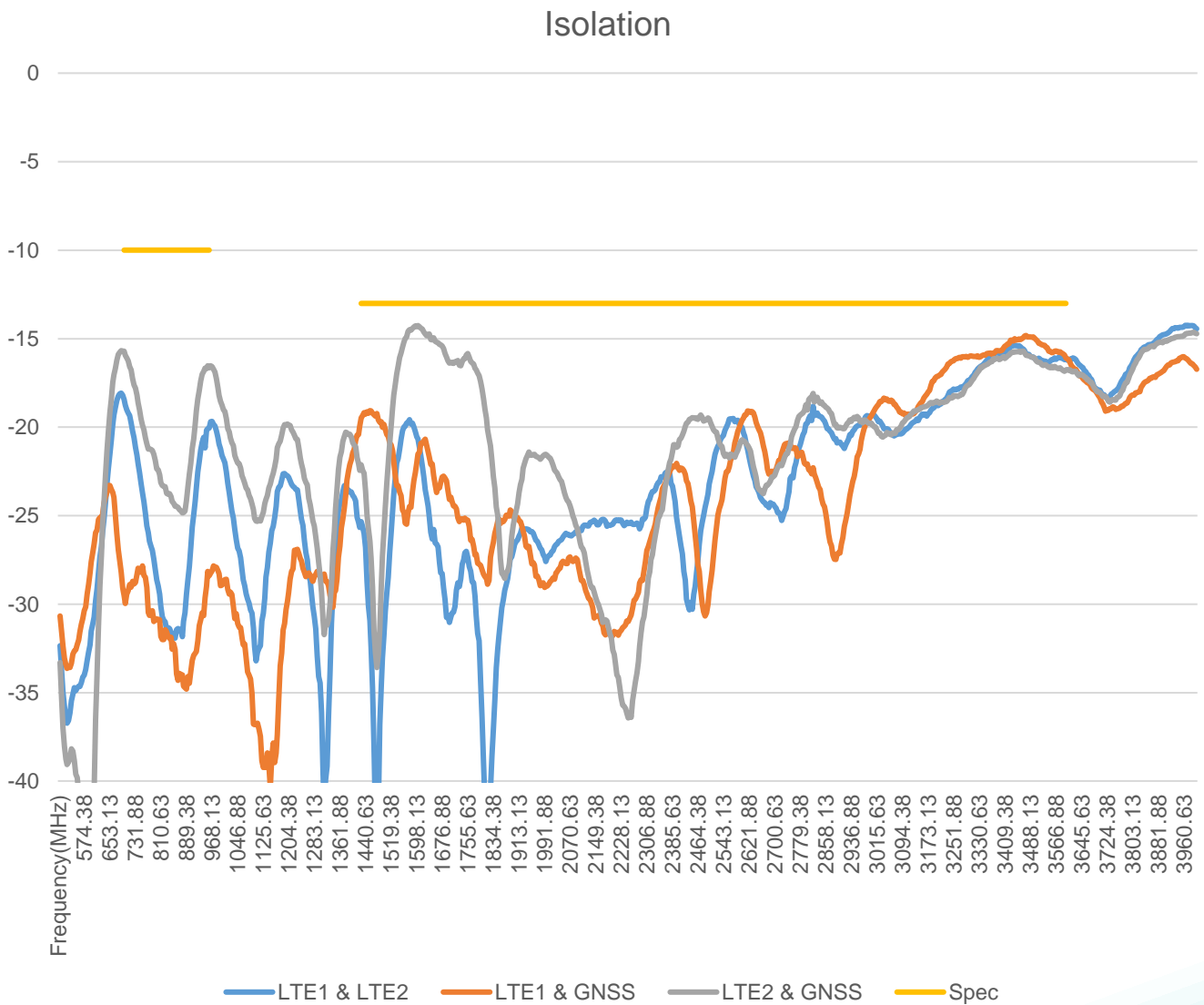

Note : All test results measured with 300mm cable length

Issue: 2435

In the effort to improve our products, we reserve the right to make changes judged to be necessary.

CONFIDENTIAL AND PROPRIETARY INFORMATION

This document contains confidential and proprietary information of Pulse Electronics, Inc. (Pulse) and is protected by copyright, trade secret and other state and federal laws. Its receipt or possession does not convey any rights to reproduce, disclose its contents, or to manufacture, use or sell anything it may describe. Reproduction, disclosure or use without specific written authorization of Pulse is strictly forbidden.

CHARTS

Efficiency(%)

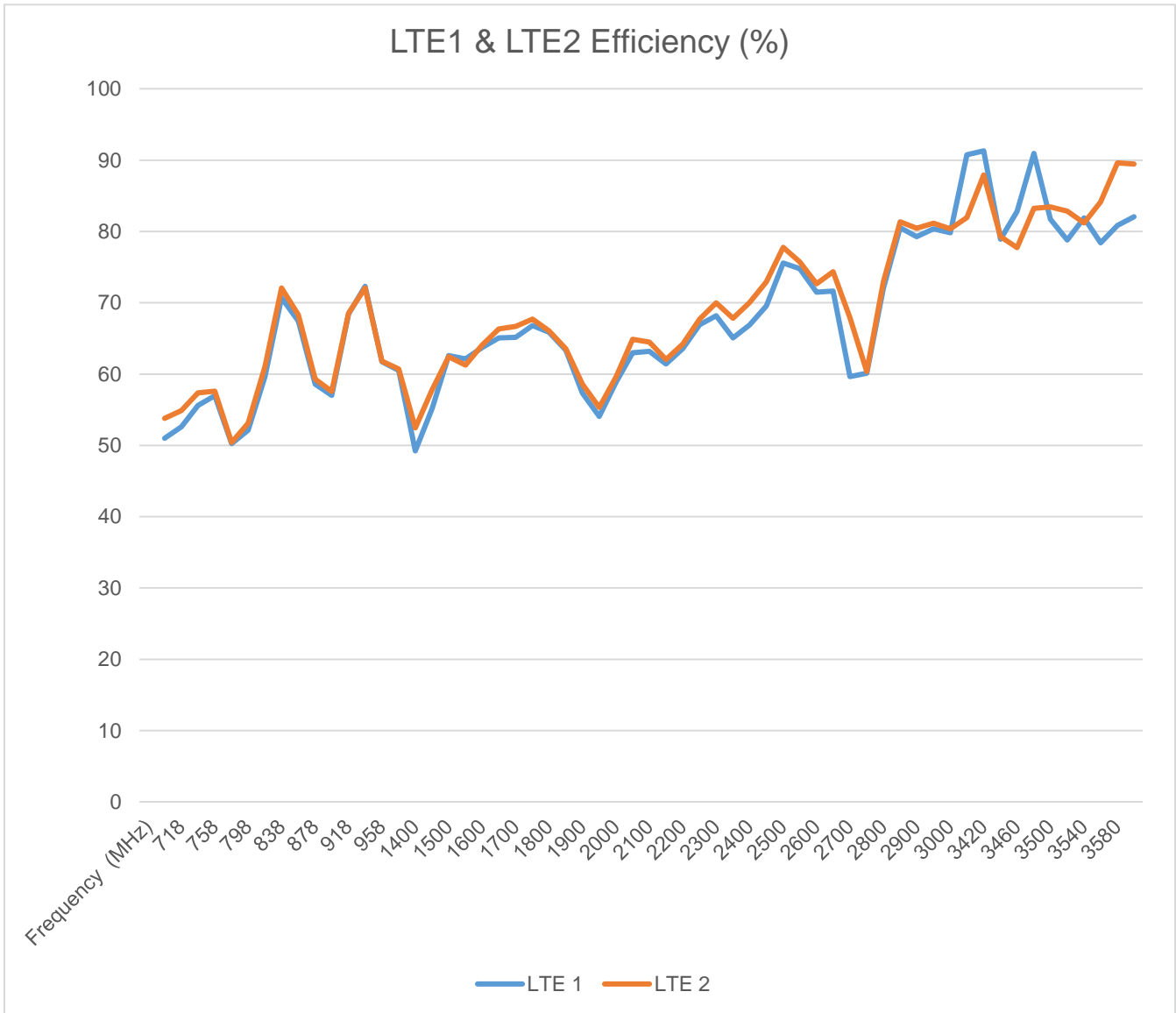

Note : All test results measured with 300mm cable length

Issue: 2435

In the effort to improve our products, we reserve the right to make changes judged to be necessary.

CONFIDENTIAL AND PROPRIETARY INFORMATION

This document contains confidential and proprietary information of Pulse Electronics, Inc. (Pulse) and is protected by copyright, trade secret and other state and federal laws. Its receipt or possession does not convey any rights to reproduce, disclose its contents, or to manufacture, use or sell anything it may describe. Reproduction, disclosure or use without specific written authorization of Pulse is strictly forbidden.

CHARTS

Efficiency(%)

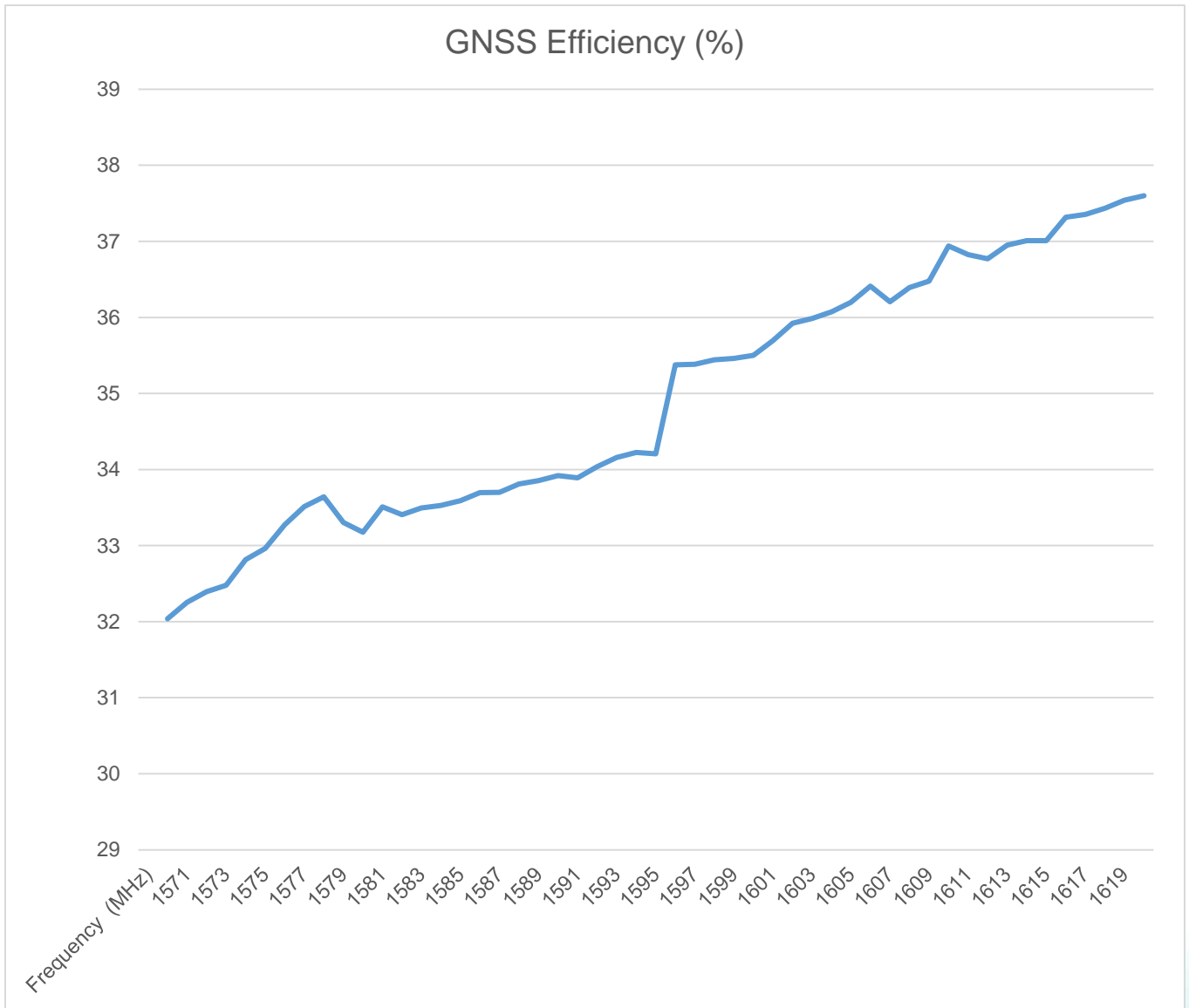

Note : All test results measured with 300mm cable length

Issue: 2435

In the effort to improve our products, we reserve the right to make changes judged to be necessary.

CONFIDENTIAL AND PROPRIETARY INFORMATION

This document contains confidential and proprietary information of Pulse Electronics, Inc. (Pulse) and is protected by copyright, trade secret and other state and federal laws. Its receipt or possession does not convey any rights to reproduce, disclose its contents, or to manufacture, use or sell anything it may describe. Reproduction, disclosure or use without specific written authorization of Pulse is strictly forbidden.

CHARTS

Peak Gain(dBi)

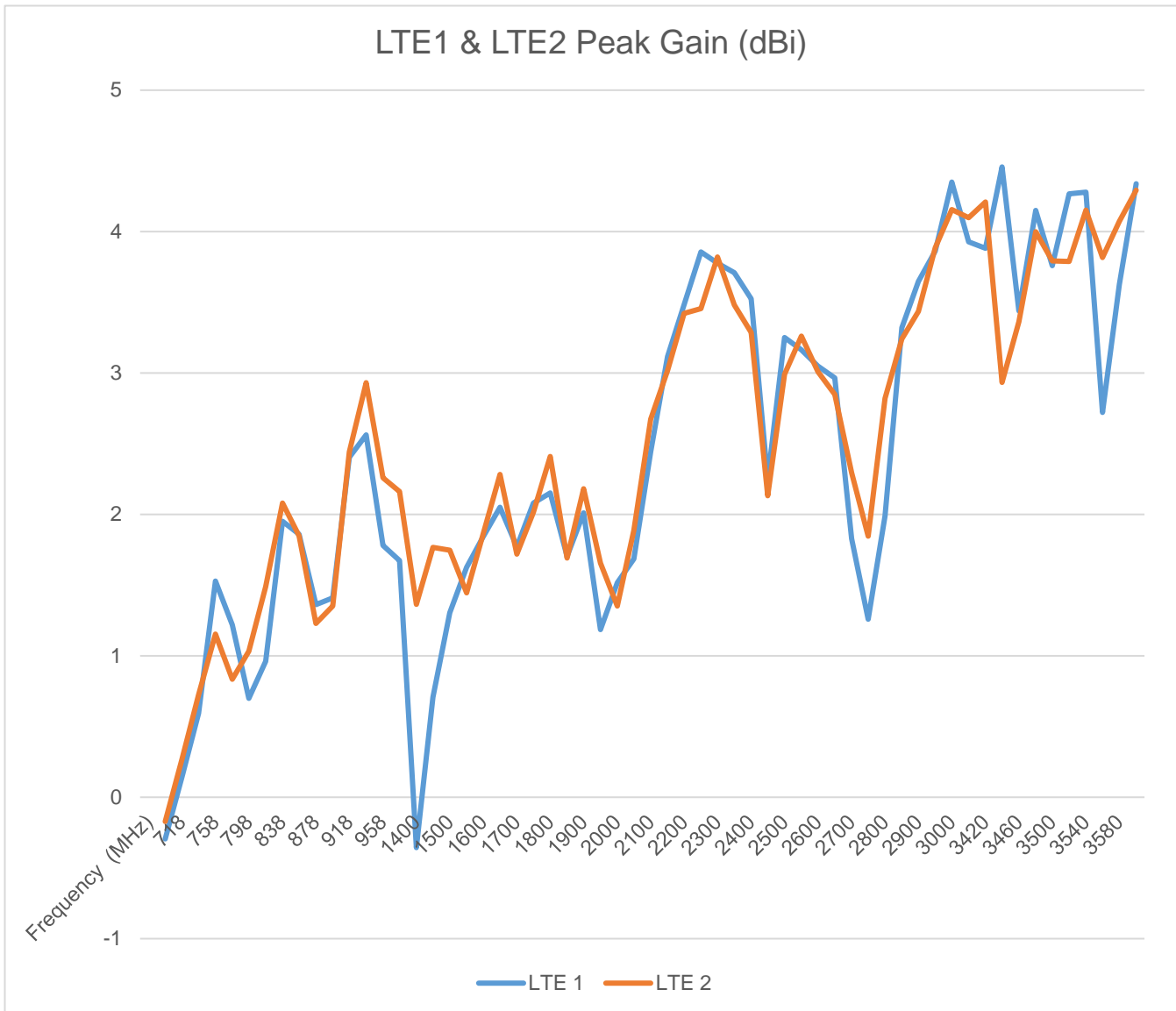

Note : All test results measured with 300mm cable length

Issue: 2435

In the effort to improve our products, we reserve the right to make changes judged to be necessary.

CONFIDENTIAL AND PROPRIETARY INFORMATION

This document contains confidential and proprietary information of Pulse Electronics, Inc. (Pulse) and is protected by copyright, trade secret and other state and federal laws. Its receipt or possession does not convey any rights to reproduce, disclose its contents, or to manufacture, use or sell anything it may describe. Reproduction, disclosure or use without specific written authorization of Pulse is strictly forbidden.

CHARTS

Peak Gain(dBi)

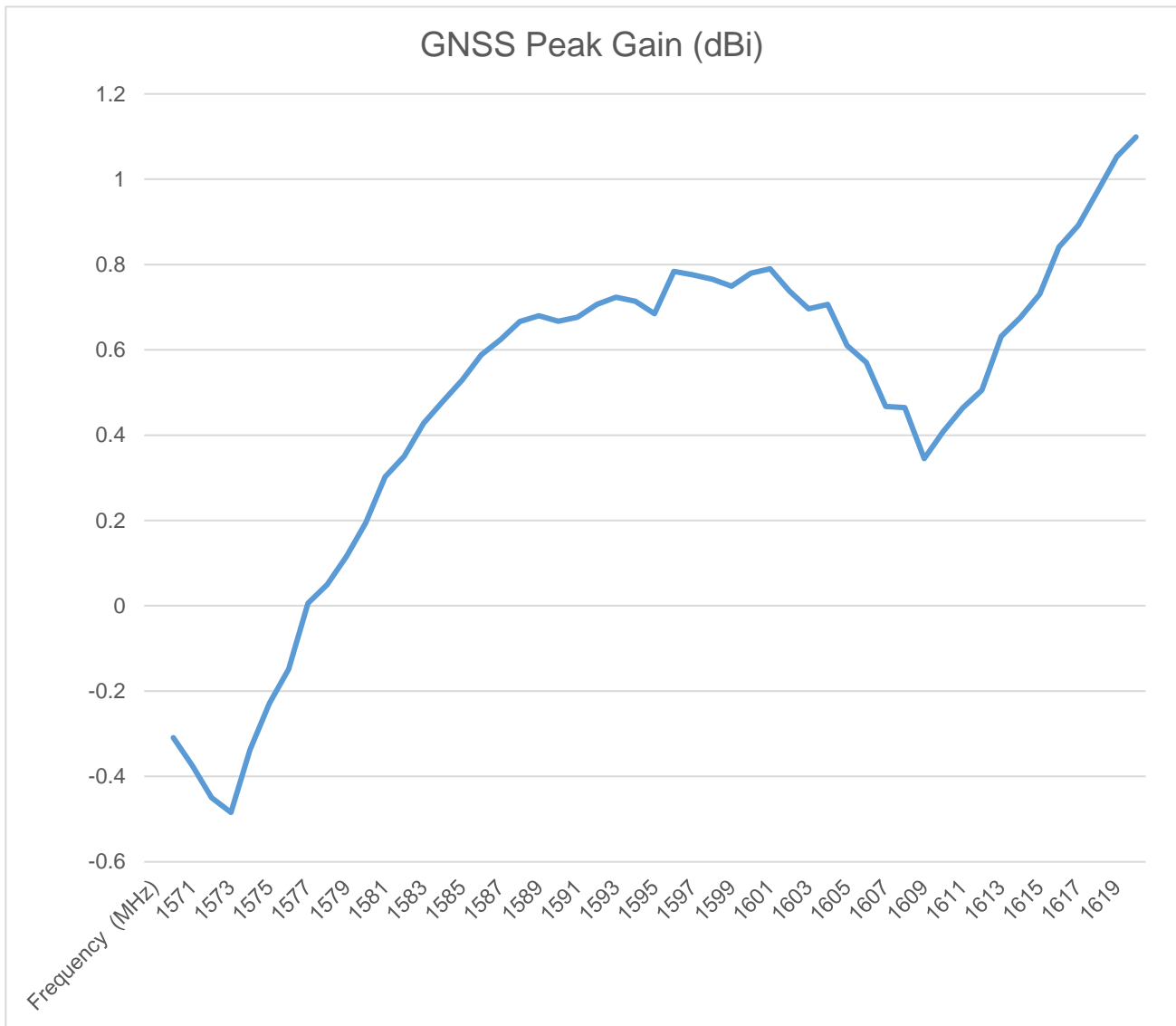

Note : All test results measured with 300mm cable length

Issue: 2435

In the effort to improve our products, we reserve the right to make changes judged to be necessary.

CONFIDENTIAL AND PROPRIETARY INFORMATION

This document contains confidential and proprietary information of Pulse Electronics, Inc. (Pulse) and is protected by copyright, trade secret and other state and federal laws. Its receipt or possession does not convey any rights to reproduce, disclose its contents, or to manufacture, use or sell anything it may describe. Reproduction, disclosure or use without specific written authorization of Pulse is strictly forbidden.

CHARTS

ECC

LTE MIMO ECC

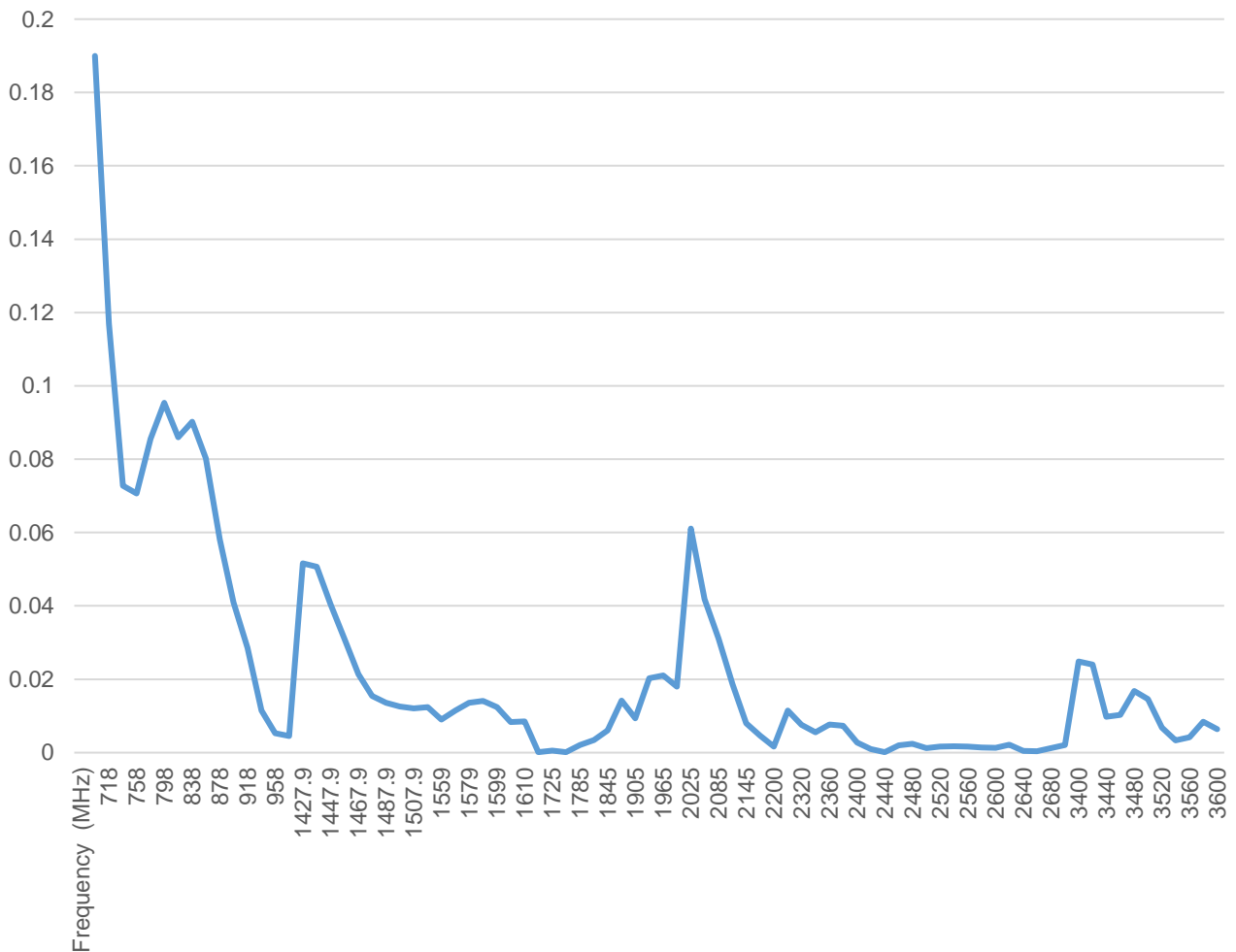

Note : All test results measured with 300mm cable length

Issue: 2435

In the effort to improve our products, we reserve the right to make changes judged to be necessary.

CONFIDENTIAL AND PROPRIETARY INFORMATION

This document contains confidential and proprietary information of Pulse Electronics, Inc. (Pulse) and is protected by copyright, trade secret and other state and federal laws. Its receipt or possession does not convey any rights to reproduce, disclose its contents, or to manufacture, use or sell anything it may describe. Reproduction, disclosure or use without specific written authorization of Pulse is strictly forbidden.

CHARTS

LTE1 & LTE2 radiation pattern
698-960MHz
(800MHz)

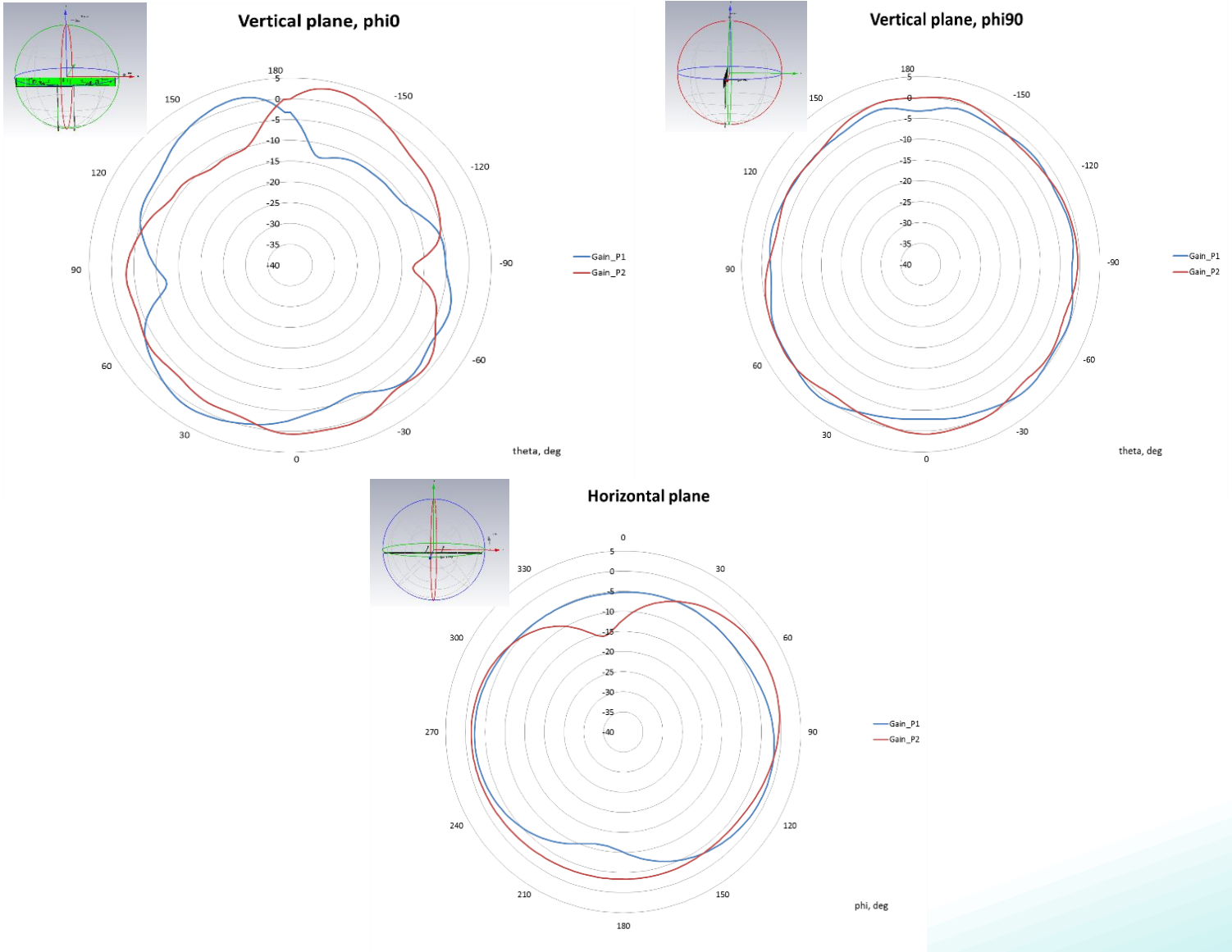

Note : All test results measured with 300mm cable length

Issue: 2435

In the effort to improve our products, we reserve the right to make changes judged to be necessary.

CONFIDENTIAL AND PROPRIETARY INFORMATION

This document contains confidential and proprietary information of Pulse Electronics, Inc. (Pulse) and is protected by copyright, trade secret and other state and federal laws. Its receipt or possession does not convey any rights to reproduce, disclose its contents, or to manufacture, use or sell anything it may describe. Reproduction, disclosure or use without specific written authorization of Pulse is strictly forbidden.

CHARTS

LTE1 & LTE2 radiation pattern
1427.9-1510.9MHz
(1450MHz)

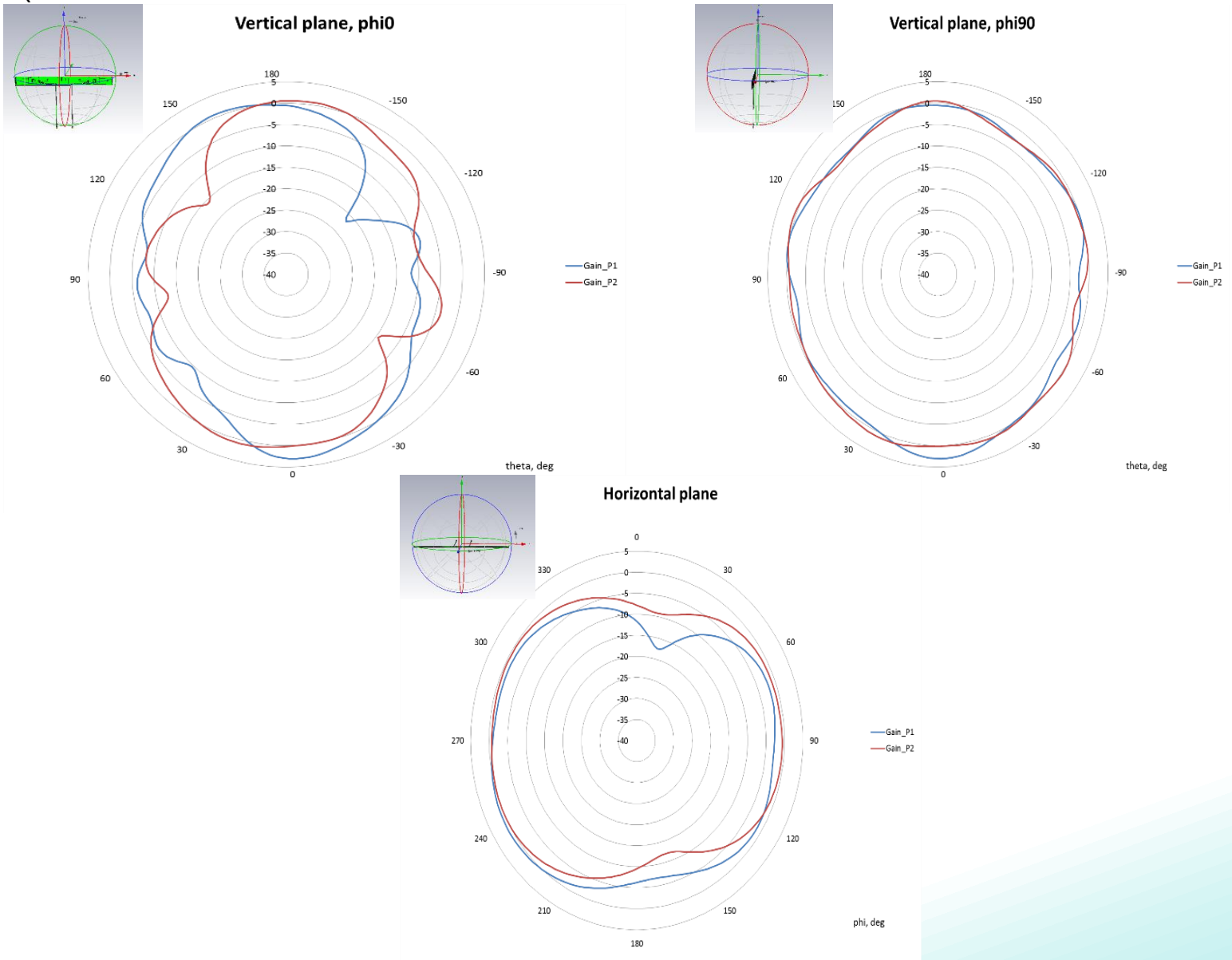

Note : All test results measured with 300mm cable length

Issue: 2435

In the effort to improve our products, we reserve the right to make changes judged to be necessary.

CONFIDENTIAL AND PROPRIETARY INFORMATION

This document contains confidential and proprietary information of Pulse Electronics, Inc. (Pulse) and is protected by copyright, trade secret and other state and federal laws. Its receipt or possession does not convey any rights to reproduce, disclose its contents, or to manufacture, use or sell anything it may describe. Reproduction, disclosure or use without specific written authorization of Pulse is strictly forbidden.

CHARTS

**LTE1 & LTE2 radiation pattern
1559-1610MHz
(1570MHz)**

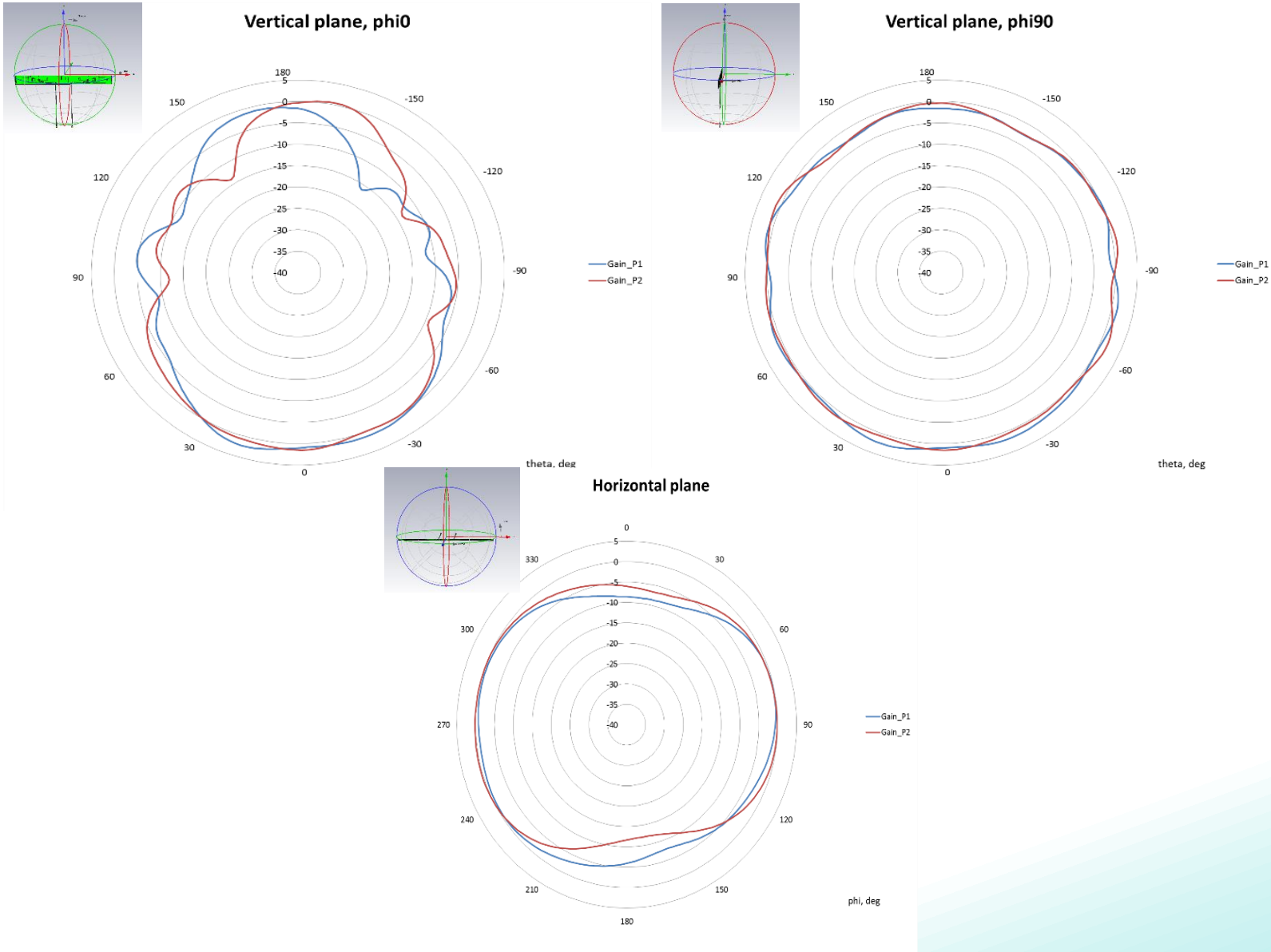

Note : All test results measured with 300mm cable length

Issue: 2435

In the effort to improve our products, we reserve the right to make changes judged to be necessary.

CONFIDENTIAL AND PROPRIETARY INFORMATION

This document contains confidential and proprietary information of Pulse Electronics, Inc. (Pulse) and is protected by copyright, trade secret and other state and federal laws. Its receipt or possession does not convey any rights to reproduce, disclose its contents, or to manufacture, use or sell anything it may describe. Reproduction, disclosure or use without specific written authorization of Pulse is strictly forbidden.

CHARTS

**LTE1 & LTE2 radiation pattern
1695-2200MHz
(1930MHz)**

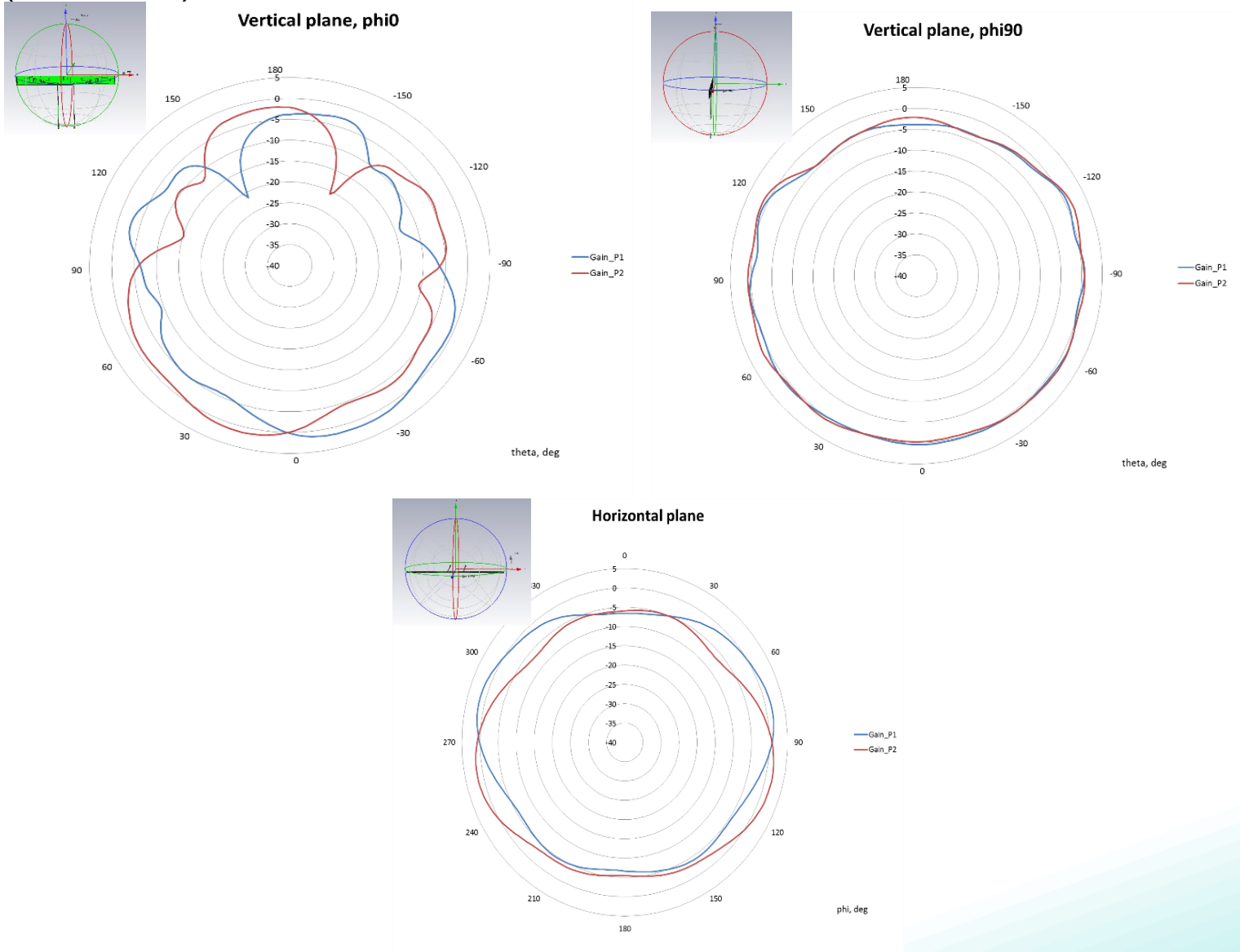

Note : All test results measured with 300mm cable length

Issue: 2435

In the effort to improve our products, we reserve the right to make changes judged to be necessary.

CONFIDENTIAL AND PROPRIETARY INFORMATION

This document contains confidential and proprietary information of Pulse Electronics, Inc. (Pulse) and is protected by copyright, trade secret and other state and federal laws. Its receipt or possession does not convey any rights to reproduce, disclose its contents, or to manufacture, use or sell anything it may describe. Reproduction, disclosure or use without specific written authorization of Pulse is strictly forbidden.

CHARTS

LTE1 & LTE2 radiation pattern
2300-2700MHz
(2390MHz)

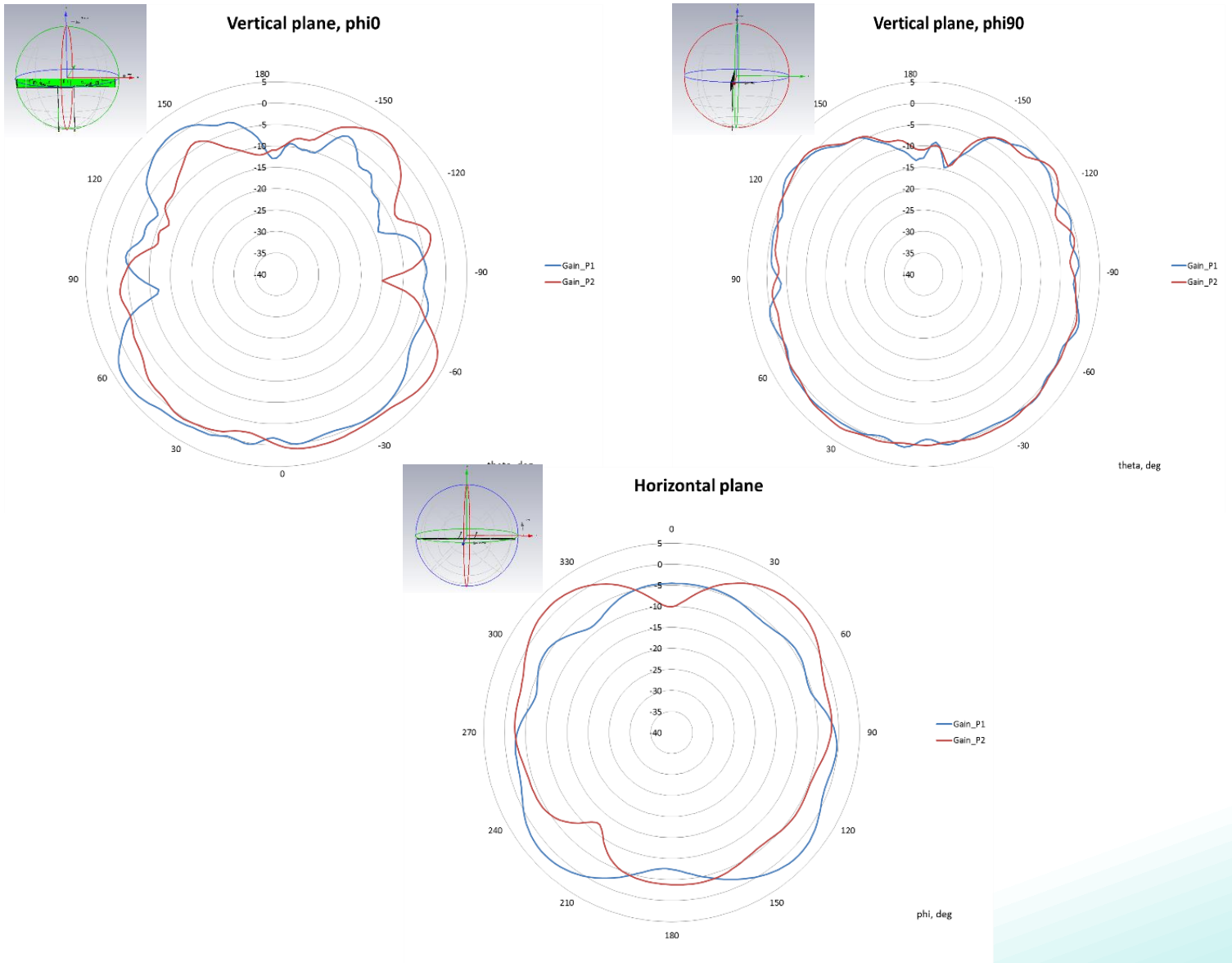

Note : All test results measured with 300mm cable length

Issue: 2435

In the effort to improve our products, we reserve the right to make changes judged to be necessary.

CONFIDENTIAL AND PROPRIETARY INFORMATION

This document contains confidential and proprietary information of Pulse Electronics, Inc. (Pulse) and is protected by copyright, trade secret and other state and federal laws. Its receipt or possession does not convey any rights to reproduce, disclose its contents, or to manufacture, use or sell anything it may describe. Reproduction, disclosure or use without specific written authorization of Pulse is strictly forbidden.

CHARTS

**LTE1 & LTE2 radiation pattern
3400-3600MHz
(3400MHz)**

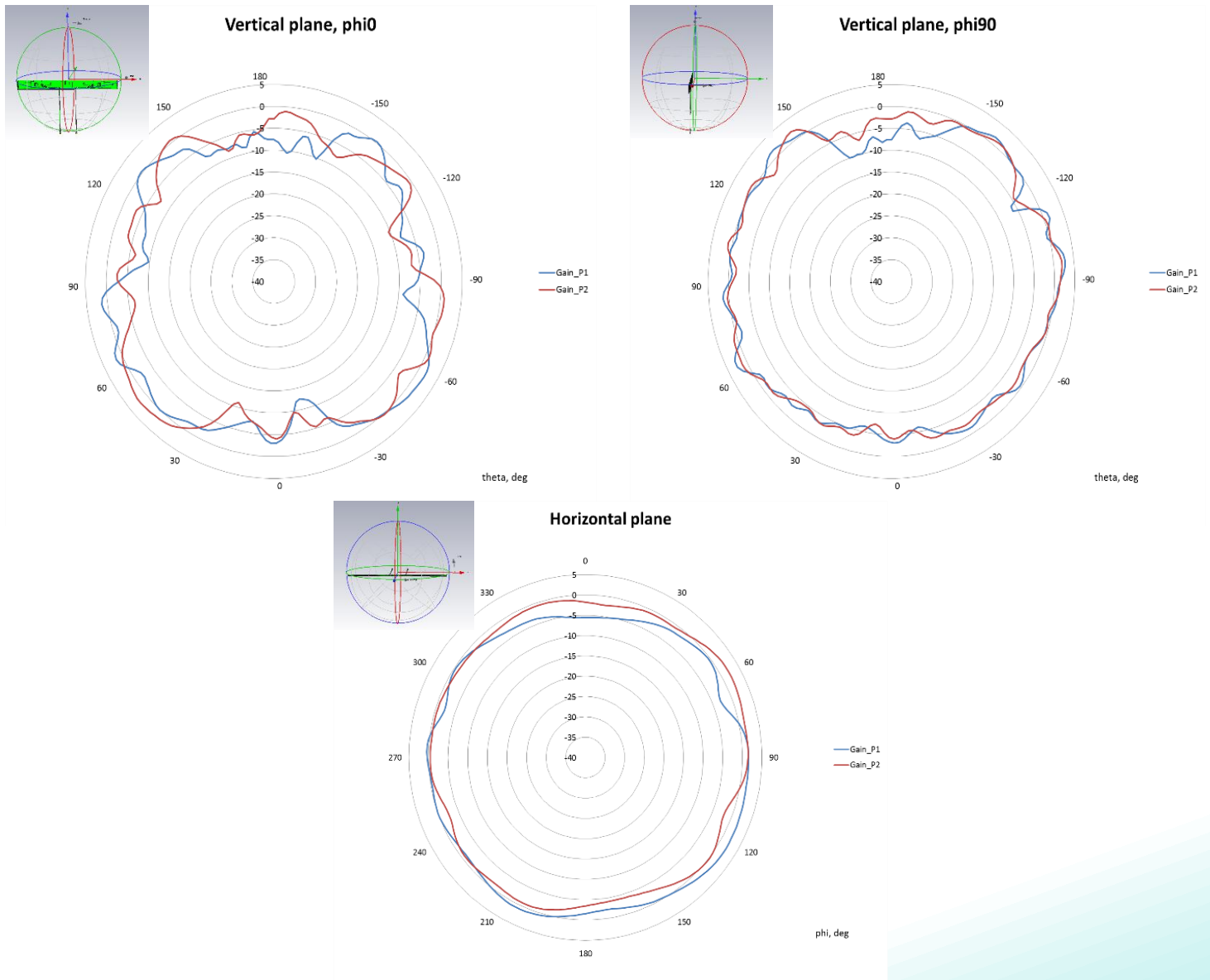

Note : All test results measured with 300mm cable length

Issue: 2435

In the effort to improve our products, we reserve the right to make changes judged to be necessary.

CONFIDENTIAL AND PROPRIETARY INFORMATION

This document contains confidential and proprietary information of Pulse Electronics, Inc. (Pulse) and is protected by copyright, trade secret and other state and federal laws. Its receipt or possession does not convey any rights to reproduce, disclose its contents, or to manufacture, use or sell anything it may describe. Reproduction, disclosure or use without specific written authorization of Pulse is strictly forbidden.

CHARTS

**GNSS radiation pattern
1570-1610MHz
(1575MHz)**

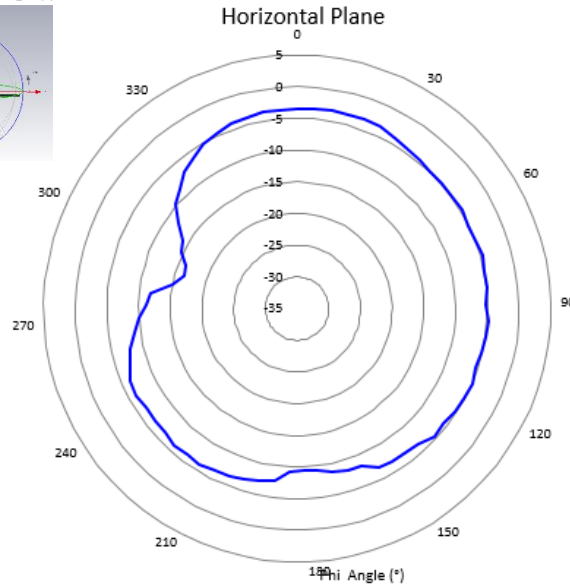
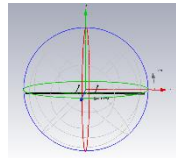
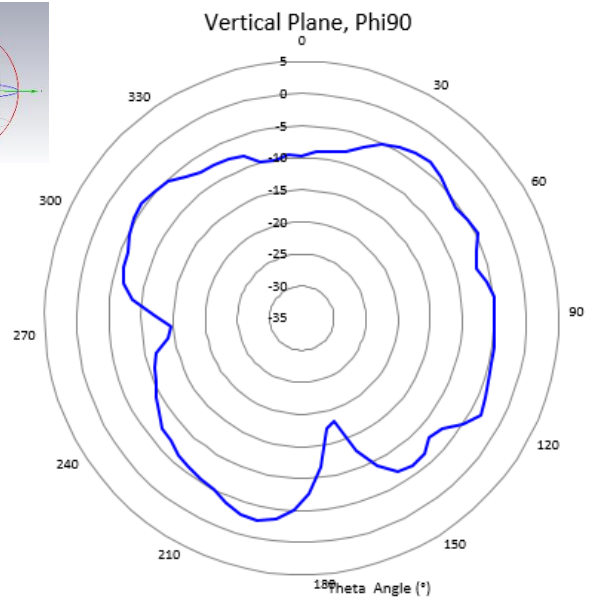
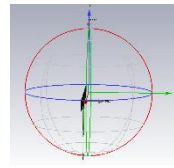
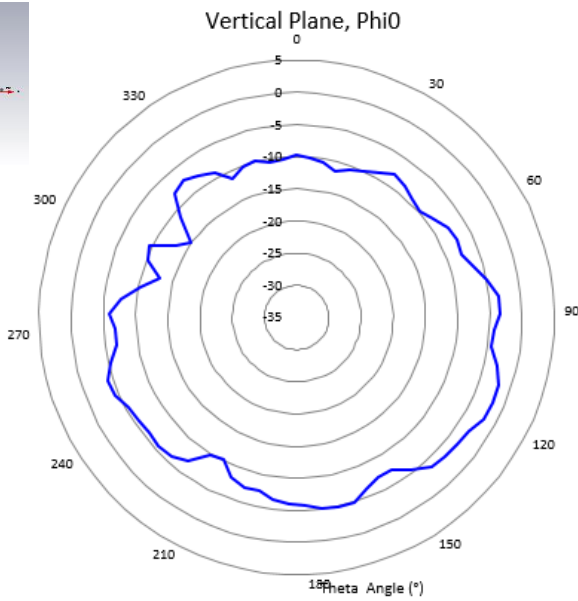
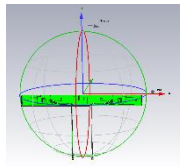

Note : All test results measured with 300mm cable length

Issue: 2435

In the effort to improve our products, we reserve the right to make changes judged to be necessary.

CONFIDENTIAL AND PROPRIETARY INFORMATION

This document contains confidential and proprietary information of Pulse Electronics, Inc. (Pulse) and is protected by copyright, trade secret and other state and federal laws. Its receipt or possession does not convey any rights to reproduce, disclose its contents, or to manufacture, use or sell anything it may describe. Reproduction, disclosure or use without specific written authorization of Pulse is strictly forbidden.

Description: 2x2 MIMO LTE + GNSS FPC
ANTENNA

Series: Internal Antenna

PART NUMBER: W6113XXXXX

PACKAGING

5PCS/PE bag
400 PE bag/foam bag
2 foam bag/ carton box

Total 4000PCS/Carton box



Issue: 2435

In the effort to improve our products, we reserve the right to make changes judged to be necessary.

CONFIDENTIAL AND PROPRIETARY INFORMATION

This document contains confidential and proprietary information of Pulse Electronics, Inc. (Pulse) and is protected by copyright, trade secret and other state and federal laws. Its receipt or possession does not convey any rights to reproduce, disclose its contents, or to manufacture, use or sell anything it may describe. Reproduction, disclosure or use without specific written authorization of Pulse is strictly forbidden.