

**Xinger III**

**Hybrid Coupler**  
**3 dB, 90°**



**Description:**

The X3C14F1-03S is a low profile, high performance 3dB hybrid coupler in a new easy to use, manufacturing friendly surface mount package. It is designed for GPS band applications. The X3C14F1-03S is designed particularly for balanced power and low noise amplifiers, plus signal distribution and other applications where low insertion loss and tight amplitude and phase balance is required. It can be used in high power applications up to 25 Watts.

Parts have been subjected to rigorous qualification testing and they are manufactured using materials with coefficients of thermal expansion (CTE) compatible with common substrates such as FR4, G-10, RF-35, and RO4350. Produced with 6 of 6 RoHS compliant tin immersion.

**Features:**

- 1200 – 1700 MHz
- GPS
- High Power
- Very Low Loss
- Tight Amplitude Balance
- High Isolation
- Production Friendly
- Tape and Reel
- Lead-Free

**Detailed Electrical Specifications:**

Frequency	Isolation	Insertion Loss	VSWR	Amplitude Balance
MHz	dB Min	dB Max	Max : 1	dB Max
1200-1700	23	0.25	1.15	± 0.35
1350-1550	25	0.20	1.12	± 0.25
Group Delay	Phase	Power	Operating Temp.	
ns	Degrees	Avg. CW Watts @ 95°C	°C	
0.16 ± 0.04	90 ± 4.0	25	-55 to +140	
0.16 ± 0.04	90 ± 4.0	25	-55 to +140	

\*\*Specification based on performance of unit properly installed on TTM Technologies Test Board 69772-PFHS with small signal applied. Specifications subject to change without notice. Refer to parameter definitions for details.

**Outline Drawing:**

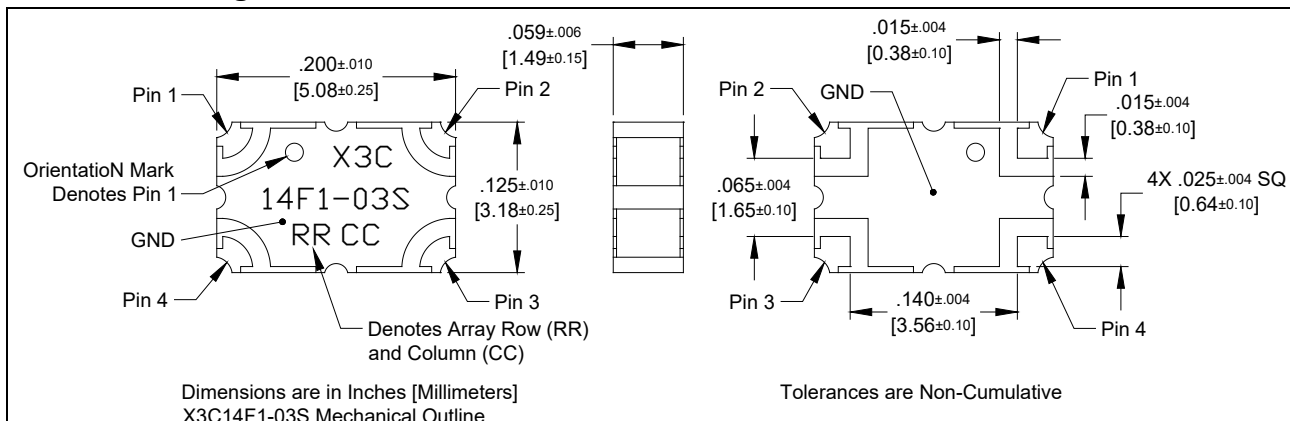

## Hybrid Coupler Pin Configuration

The X3C14F1-03S has an orientation marker to denote Pin 1. Once port one has been identified the other ports are known automatically. Please see the chart below for clarification:

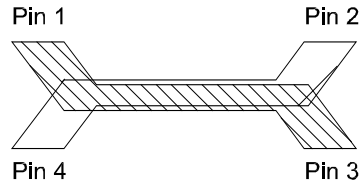

Configuration	Pin 1	Pin 2	Pin 3	Pin 4
<b>Splitter</b>	Input	Isolated	-3dB $\angle\theta - 90$	-3dB $\angle\theta$
<b>Splitter</b>	Isolated	Input	-3dB $\angle\theta$	-3dB $\angle\theta - 90$
<b>Splitter</b>	-3dB $\angle\theta - 90$	-3dB $\angle\theta$	Input	Isolated
<b>Splitter</b>	-3dB $\angle\theta$	-3dB $\angle\theta - 90$	Isolated	Input
<b>*Combiner</b>	$A \angle\theta - 90$	$A \angle\theta$	Isolated	Output
<b>*Combiner</b>	$A \angle\theta$	$A \angle\theta - 90$	Output	Isolated
<b>*Combiner</b>	Isolated	Output	$A \angle\theta - 90$	$A \angle\theta$
<b>*Combiner</b>	Output	Isolated	$A \angle\theta$	$A \angle\theta - 90$

\*Notes: "A" is the amplitude of the applied signals. When two quadrature signals with equal amplitudes are applied to the coupler as described in the table, they will combine at the output port. If the amplitudes are not equal, some of the applied energy will be directed to the isolated port.

The actual phase,  $\angle\theta$ , or amplitude at a given frequency for all ports, can be seen in our de-embedded s-parameters, that can be downloaded at [www.TTM.com](http://www.TTM.com).

## Peak Power Handling

High-Pot testing of these couplers during the qualification procedure resulted in a minimum breakdown voltage of 1.25Kv (minimum recorded value). This voltage level corresponds to a breakdown resistance capable of handling at least 12dB peaks over average power levels, for very short durations. The breakdown location consistently occurred across the air interface at the coupler contact pads (see illustration below). The breakdown levels at these points will be affected by any contamination in the gap area around these pads. These areas must be kept clean for optimum performance. It is recommended that the user test for voltage breakdown under the maximum operating conditions and over worst case modulation induced power peaking. This evaluation should also include extreme environmental conditions (such as high humidity).

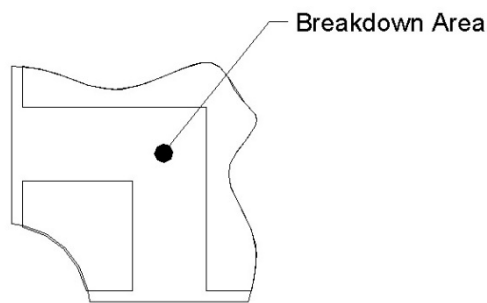

## Insertion Loss and Power Derating Curves

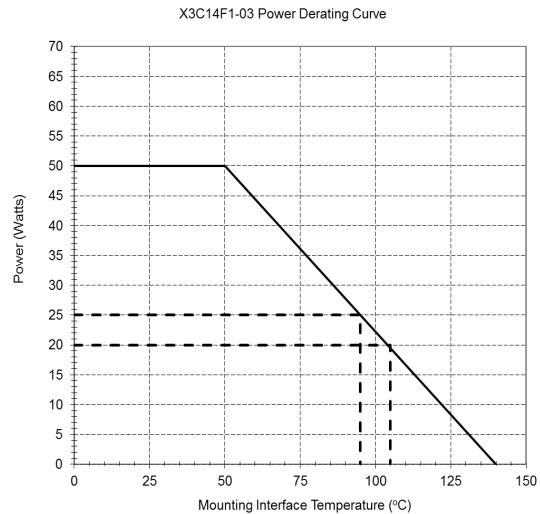
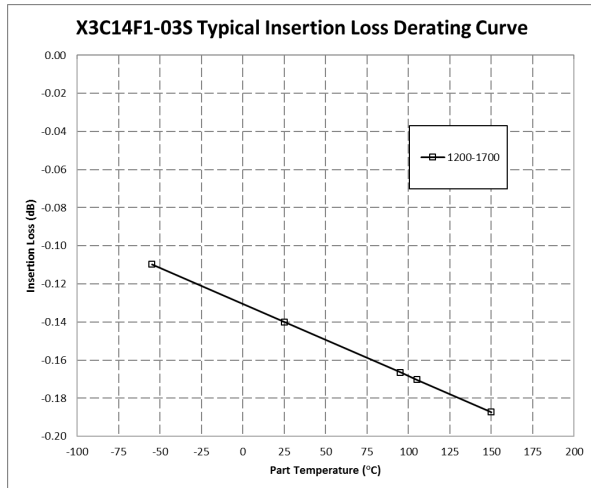

### Insertion Loss Derating:

The insertion loss, at a given frequency, of a group of couplers is measured at 25°C and then averaged. The measurements are performed under small signal conditions (i.e. using a Vector Network Analyzer). The process is repeated at 85°C and 140°C. A best-fit line for the measured data is computed and then plotted from -55°C to 150°C.

### Power Derating:

The power handling and corresponding power derating plots are a function of the thermal resistance, mounting surface temperature (base plate temperature), maximum continuous operating temperature of the coupler, and the thermal insertion loss. The thermal insertion loss is defined in the Power Handling section of the data sheet.

As the mounting interface temperature approaches the maximum continuous operating temperature, the power handling decreases to zero.

If mounting temperature is greater than 95°C, Xinger coupler will perform reliably as long as the input power is derated to the curve above.

**Typical Performance: (-55°C, 25°C, 95°C, 105°C): 1200-1700 MHz**

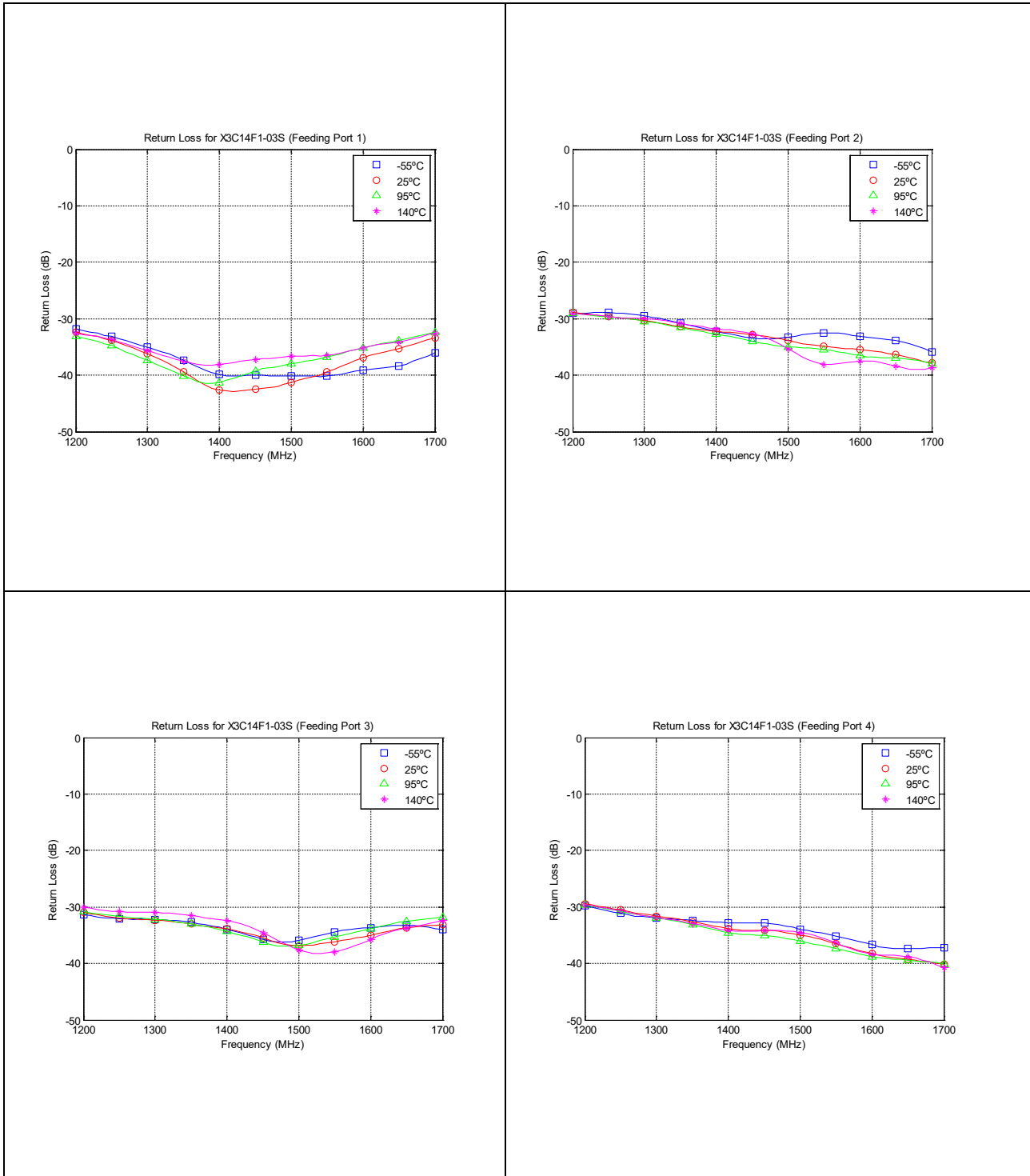

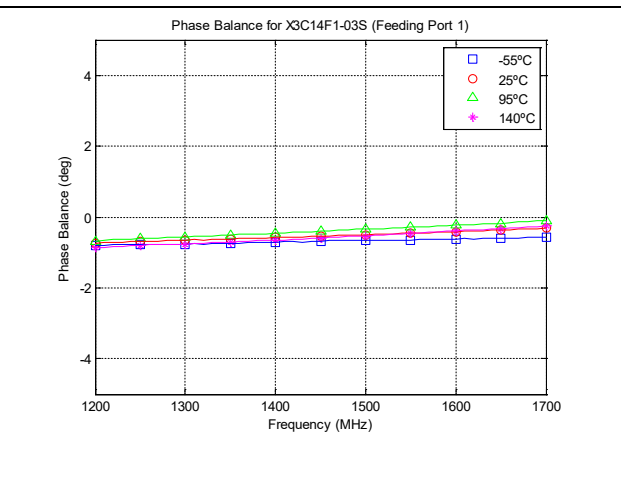
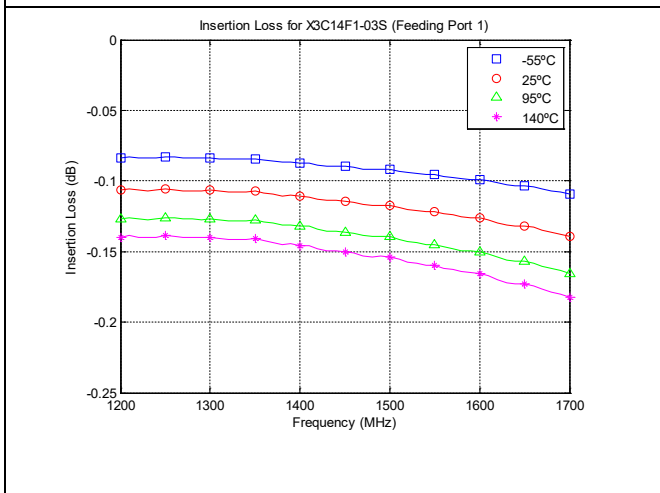
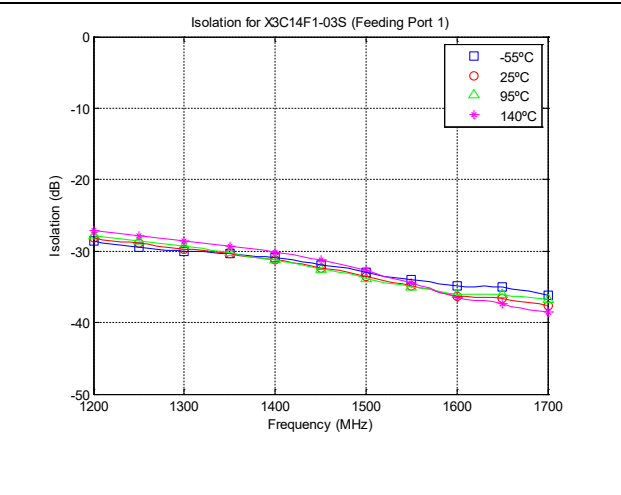
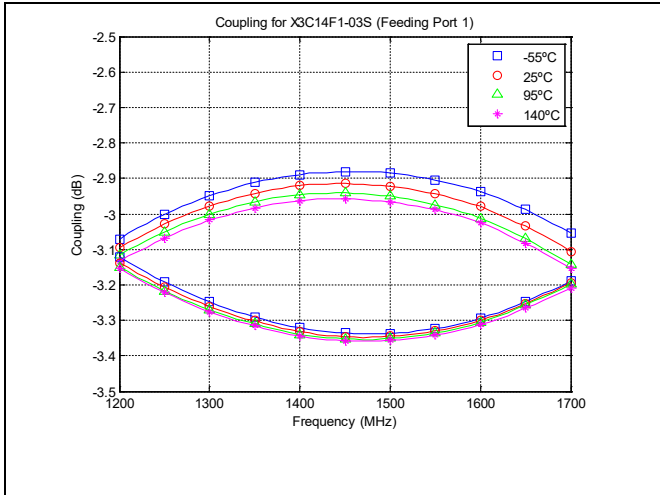

## Definition of Measured Specifications

Parameter	Definition	Mathematical Representation
<b>VSWR (Voltage Standing Wave Ratio)</b>	The impedance match of the coupler to a 50Ω system. A VSWR of 1:1 is optimal.	$VSWR = \frac{V_{max}}{V_{min}}$ Vmax = voltage maxima of a standing wave Vmin = voltage minima of a standing wave
<b>Return Loss</b>	The impedance match of the coupler to a 50Ω system. Return Loss is an alternate means to express VSWR.	$Return\ Loss(dB) = 20\log \frac{VSWR + 1}{VSWR - 1}$
<b>Insertion Loss</b>	The input power divided by the sum of the power at the two output ports.	$Insertion\ Loss(dB) = 10\log \frac{P_{in}}{P_{cpl} + P_{direct}}$
<b>Isolation</b>	The input power divided by the power at the isolated port.	$Isolation(dB) = 10\log \frac{P_{in}}{P_{iso}}$
<b>Phase Balance</b>	The difference in phase angle between the two output ports.	Phase at coupled port – Phase at direct port
<b>Amplitude Balance</b>	The power at each output divided by the average power of the two outputs.	$10\log \frac{P_{cpl}}{(P_{cpl}+P_{direct})/2} \text{ and } 10\log \frac{P_{direct}}{(P_{cpl}+P_{direct})/2}$
<b>Group Delay</b>	Group delay is average of group delay's from input port to the coupled port	Average (GD-C)

## Packaging and Ordering Information

Parts are available in reels. Packaging follows EIA 481-D for reels. Parts are oriented in tape and reel as shown below. Tape and reel is available in 4000 pcs per reel.

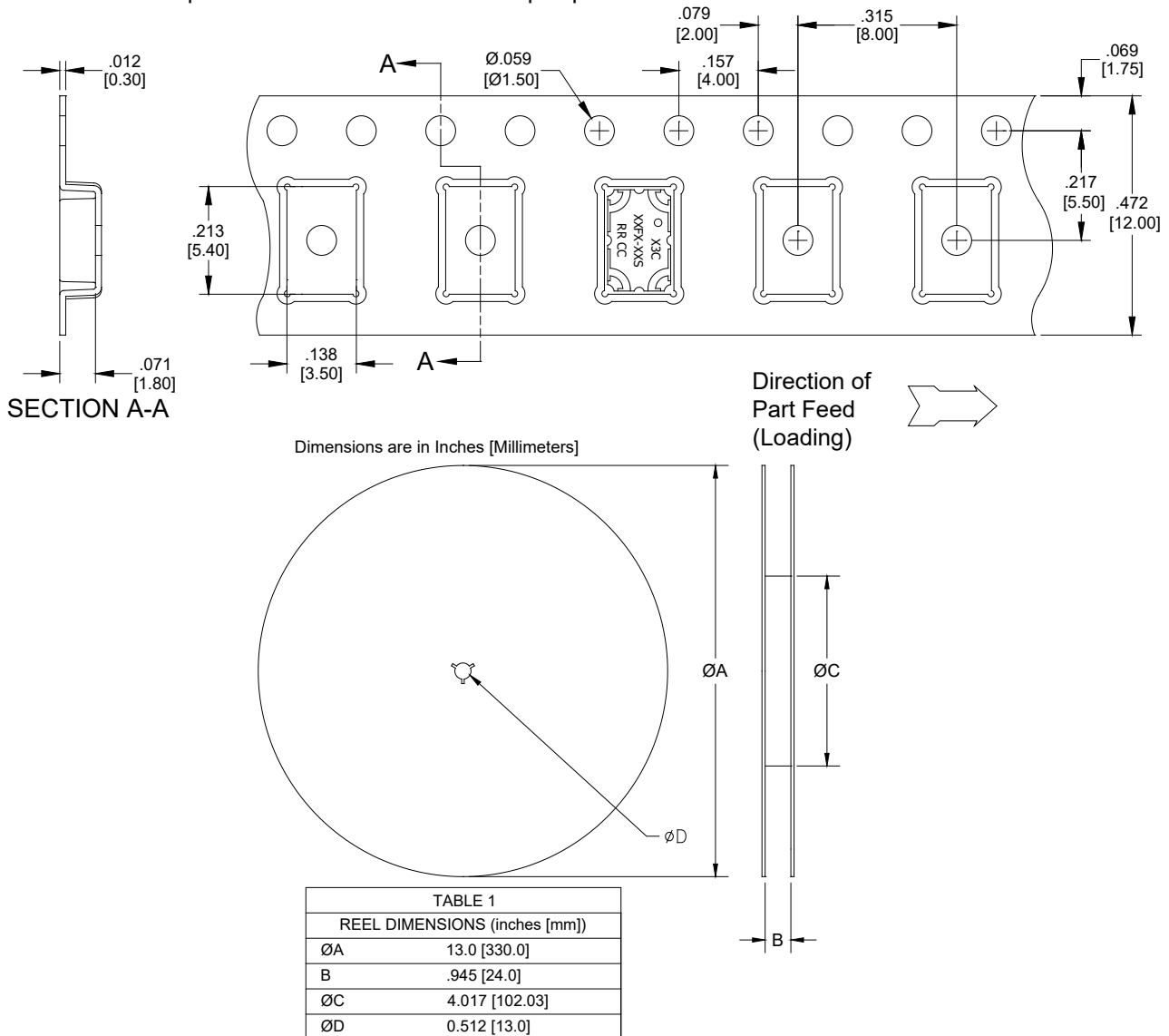

Contact us:  
[rf&s\\_support@ttm.com](mailto:rf&s_support@ttm.com)