

## Surface Mount Transient Voltage Suppressors (TVS)

**SMBJ Series 5.0 To 440 V 600W**

### Description

The SMBJ series is designed specifically to protect sensitive electronic equipment from voltage transients induced by lightning and other transient voltage events.

### Features

- u For surface mounted applications in order to optimize board space
- u Low leakage
- u Uni and Bidirectional unit
- u Glass passivated junction
- u Low inductance
- u Excellent clamping capability
- u 600W Peak power capability at 10 × 1000μs waveform Repetition rate (duty cycle):0.01%
- u Fast response time: typically less than 1.0ps from 0 Volts to  $V_{BR}$  min
- u Typical  $I_R$  less than 5μA above 12V.
- u High Temperature soldering: 260°C/40 seconds at terminals
- u Typical maximum temperature coefficient  $\Delta V_{BR} = 0.1\% \times V_{BR@25^\circ C} \times \Delta T$
- u Plastic package has Underwriters Laboratory Flammability 94V-0
- u Matte tin lead-free Plated
- u Halogen free and RoHS compliant
- u Typical failure mode is short from over-specified voltage or current
- u Whisker test is conducted based on JEDEC JESD201A per its table 4a and 4c
- u IEC-61000-4-2 ESD 15kV(Air), 8kV (Contact)
- u ESD protection of data lines in accordance with IEC 61000-4-2 (IEC801-2)
- u EFT protection of data lines in accordance with IEC 61000-4-4 (IEC801-4)

Uni-directional

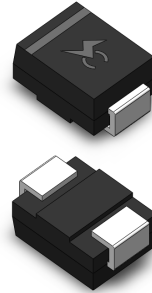

Bi-directional

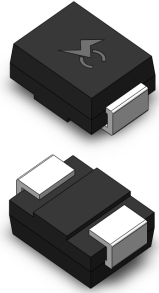

### Functional Diagram

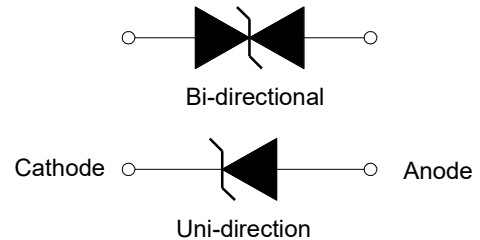

### Agency Approvals

AGENCY	AGENCY FILE NUMBER
	E341027

### Applications

TVS devices are ideal for the protection of I/O interfaces,  $V_{CC}$  bus and other vulnerable circuits used in Telecom, Computer, Industrial and Consumer electronic applications.

### Maximum Ratings ( $T_A=25^\circ C$ unless otherwise noted)

Parameter	Symbol	Value	Unit
Peak Pulse Power Dissipation with a 10/1000μs waveform (Fig.1)(Note 1), (Note 2)	$P_{PPM}$	600	Watts
Peak Pulse Current with a 10/1000μs waveform.(Note1, Fig.3)	$I_{PP}$	See Next Table	Amps
Power Dissipation on Infinite Heat Sink at $T_L=75^\circ C$	$P_{M(AV)}$	5.0	Watt
Peak Forward Surge Current, 8.3ms Single Half Sine Wave (Note 3)	$I_{FSM}$	100	Amps
Maximum Instantaneous Forward Voltage at 25A for Unidirectional Only (Note 4)	$V_F$	3.5/5.0	Voltage
Operating junction and Storage Temperature Range.	$T_J, T_{STG}$	-55 to +150	$^\circ C$

### Notes:

1. Non-repetitive current pulse, per Fig. 3 and derated above  $T_A = 25^\circ C$  per Fig. 2.
2. Mounted on 5.0mm x 5.0mm (0.03mm thick) Copper Pads to each terminal.
3. 8.3ms single half sine-wave, or equivalent square wave, Duty cycle = 4 pulses per minutes maximum.
4.  $V_F < 3.5V$  for  $V_{BR} < 200V$  and  $V_F < 6.5V$  for  $V_{BR} > 201V$ .

## Surface Mount Transient Voltage Suppressors (TVS)

**SMBJ Series 5.0 To 440 V 600W**

Electrical Characteristics ( $T_A=25^\circ\text{C}$  unless otherwise noted)

Part Number		Marking		Reverse Stand-Off Voltage $V_{RWM}$ (V)	Breakdown Voltage $V_{BR}$ (V) @ $I_T$		Test Current $I_T$ (mA)	Maximum Clamping Voltage $V_C$ @ $I_{PP}$ (V)	Maximum Peak Pulse Current $I_{PP}$ (A)	Maximum Reverse Leakage $I_R$ @ $V_{RWM}$ ( $\mu\text{A}$ )
Uni	Bi	Uni	Bi		MIN	MAX				
SMBJ3.3A	—	K1	—	3.3	5.20	6.50	10	8.0	75.00	600
SMBJ5.0A	SMBJ5.0CA	KE	AE	5.0	6.40	7.00	10	9.2	65.22	800
SMBJ6.0A	SMBJ6.0CA	KG	AG	6.0	6.67	7.37	10	10.3	58.25	800
SMBJ6.5A	SMBJ6.5CA	KK	AK	6.5	7.22	7.98	10	11.2	53.57	500
SMBJ7.0A	SMBJ7.0CA	KM	AM	7.0	7.78	8.60	10	12.0	50.00	200
SMBJ7.5A	SMBJ7.5CA	KP	AP	7.5	8.33	9.21	1	12.9	46.51	100
SMBJ8.0A	SMBJ8.0CA	KR	AR	8.0	8.89	9.83	1	13.6	44.12	50
SMBJ8.5A	SMBJ8.5CA	KT	AT	8.5	9.44	10.40	1	14.4	41.67	10
SMBJ9.0A	SMBJ9.0CA	KV	AV	9.0	10.00	11.10	1	15.4	38.96	5
SMBJ10A	SMBJ10CA	KX	AX	10.0	11.10	12.30	1	17.0	35.29	5
SMBJ11A	SMBJ11CA	KZ	WZ	11.0	12.20	13.50	1	18.2	32.97	5
SMBJ12A	SMBJ12CA	LE	BE	12.0	13.30	14.70	1	19.9	30.15	5
SMBJ13A	SMBJ13CA	LG	BG	13.0	14.40	15.90	1	21.5	27.91	5
SMBJ14A	SMBJ14CA	LK	BK	14.0	15.60	17.20	1	23.2	25.86	5
SMBJ15A	SMBJ15CA	LM	BM	15.0	16.70	18.50	1	24.4	24.59	5
SMBJ16A	SMBJ16CA	LP	BP	16.0	17.80	19.70	1	26.0	23.08	5
SMBJ17A	SMBJ17CA	LR	BR	17.0	18.90	20.90	1	27.6	21.74	5
SMBJ18A	SMBJ18CA	LT	BT	18.0	20.00	22.10	1	29.2	20.55	5
SMBJ19A	SMBJ19CA	LB	BB	19.0	21.10	23.30	1	30.8	19.49	5
SMBJ20A	SMBJ20CA	LV	BV	20.0	22.20	24.50	1	32.4	18.52	5
SMBJ22A	SMBJ22CA	LX	BX	22.0	24.40	26.90	1	35.5	16.90	5
SMBJ24A	SMBJ24CA	LZ	BZ	24.0	26.70	29.50	1	38.9	15.42	5
SMBJ26A	SMBJ26CA	ME	CE	26.0	28.90	31.90	1	42.1	14.25	5
SMBJ28A	SMBJ28CA	MG	CG	28.0	31.10	34.40	1	45.4	13.22	5
SMBJ30A	SMBJ30CA	MK	CK	30.0	33.30	36.80	1	48.4	12.40	5
SMBJ33A	SMBJ33CA	MM	CM	33.0	36.70	40.60	1	53.3	11.26	5
SMBJ36A	SMBJ36CA	MP	CP	36.0	40.00	44.20	1	58.1	10.33	5
SMBJ40A	SMBJ40CA	MR	CR	40.0	44.40	49.10	1	64.5	9.30	5
SMBJ43A	SMBJ43CA	MT	CT	43.0	47.80	52.80	1	69.4	8.65	5

## Surface Mount Transient Voltage Suppressors (TVS)

**SMBJ Series 5.0 To 440 V 600W**
**Electrical Characteristics (T<sub>A</sub>=25°C unless otherwise noted) (Continue)**

Part Number		Marking		Reverse Stand-Off Voltage V <sub>RWM</sub> (V)	Breakdown Voltage V <sub>BR</sub> (V) @I <sub>T</sub>		Test Current I <sub>T</sub> (mA)	Maximum Clamping Voltage V <sub>C</sub> @I <sub>PP</sub> (V)	Maximum Peak Pulse Current I <sub>PP</sub> (A)	Maximum Reverse Leakage I <sub>R</sub> @V <sub>RWM</sub> (μA)
Uni	Bi	Uni	Bi		MIN	MAX				
SMBJ45A	SMBJ45CA	MV	CV	45.0	50.00	55.30	1	72.7	8.25	5
SMBJ48A	SMBJ48CA	MX	CX	48.0	53.30	58.90	1	77.4	7.75	5
SMBJ51A	SMBJ51CA	MZ	CZ	51.0	56.70	62.70	1	82.4	7.28	5
SMBJ54A	SMBJ54CA	NE	DE	54.0	60.00	66.30	1	87.1	6.89	5
SMBJ58A	SMBJ58CA	NG	DG	58.0	64.40	71.20	1	93.6	6.41	5
SMBJ60A	SMBJ60CA	NK	DK	60.0	66.70	73.70	1	96.8	6.20	5
SMBJ64A	SMBJ64CA	NM	DM	64.0	71.10	78.60	1	103.0	5.83	5
SMBJ70A	SMBJ70CA	NP	DP	70.0	77.80	86.00	1	113.0	5.31	5
SMBJ75A	SMBJ75CA	NR	DR	75.0	83.30	92.10	1	121.0	4.96	5
SMBJ78A	SMBJ78CA	NT	DT	78.0	86.70	95.80	1	126.0	4.76	5
SMBJ80A	SMBJ80CA	NB	DB	80.0	88.80	97.60	1	129.6	4.63	5
SMBJ85A	SMBJ85CA	NV	DV	85.0	94.40	104.00	1	137.0	4.38	5
SMBJ90A	SMBJ90CA	NX	DX	90.0	100.00	111.00	1	146.0	4.11	5
SMBJ100A	SMBJ100CA	NZ	DZ	100.0	111.00	123.00	1	162.0	3.70	5
SMBJ110A	SMBJ110CA	PE	EE	110.0	122.00	135.00	1	177.0	3.39	5
SMBJ120A	SMBJ120CA	PG	EG	120.0	133.00	147.00	1	193.0	3.11	5
SMBJ130A	SMBJ130CA	PK	EK	130.0	144.00	159.00	1	209.0	2.87	5
SMBJ140A	SMBJ140CA	PB	EB	140.0	155.00	171.00	1	226.8	2.65	5
SMBJ150A	SMBJ150CA	PM	EM	150.0	167.00	185.00	1	243.0	2.47	5
SMBJ160A	SMBJ160CA	PP	EP	160.0	178.00	197.00	1	259.0	2.32	5
SMBJ170A	SMBJ170CA	PR	ER	170.0	189.00	209.00	1	275.0	2.18	5
SMBJ180A	SMBJ180CA	PT	ET	180.0	201.00	220.00	1	291.6	2.06	5
SMBJ190A	SMBJ190CA	PV	EV	190.0	211.00	232.00	1	307.8	1.95	5
SMBJ200A	SMBJ200CA	PW	EW	200.0	224.00	247.00	1	324.0	1.85	5
SMBJ220A	SMBJ220CA	PX	EX	220.0	246.00	272.00	1	356.0	1.69	5
SMBJ250A	SMBJ250CA	PZ	EZ	250.0	279.00	309.00	1	405.0	1.48	5
SMBJ300A	SMBJ300CA	QE	FE	300.0	335.00	371.00	1	486.0	1.23	5
SMBJ350A	SMBJ350CA	QG	FG	350.0	391.00	432.00	1	567.0	1.06	5
SMBJ400A	SMBJ400CA	QK	FK	400.0	447.00	494.00	1	648.0	0.93	5
SMBJ440A	SMBJ440CA	QM	FM	440.0	492.00	543.00	1	713.0	0.84	5

**Note:**

- Suffix 'A' denotes 5% tolerance device.
- Add suffix 'CA' after part number to specify Bi-directional devices.
- For Bi-Directional devices having V<sub>R</sub> of 10 volts and under, the I<sub>R</sub> limit is double.

# Surface Mount Transient Voltage Suppressors (TVS)

**SMBJ Series 5.0 To 440 V 600W**

Ratings and Characteristic Curves ( $T_A=25^\circ\text{C}$  unless otherwise noted)

**Figure 1 - Peak Pulse Power Rating Curve**

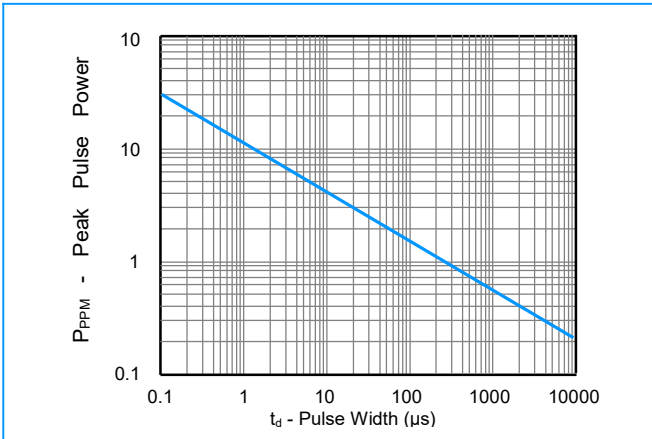

**Figure 2 - Pulse Derating Curve**

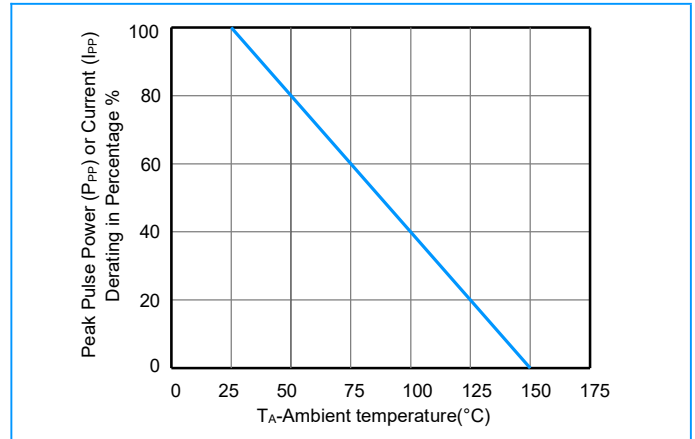

**Figure 3 - Pulse Waveform**

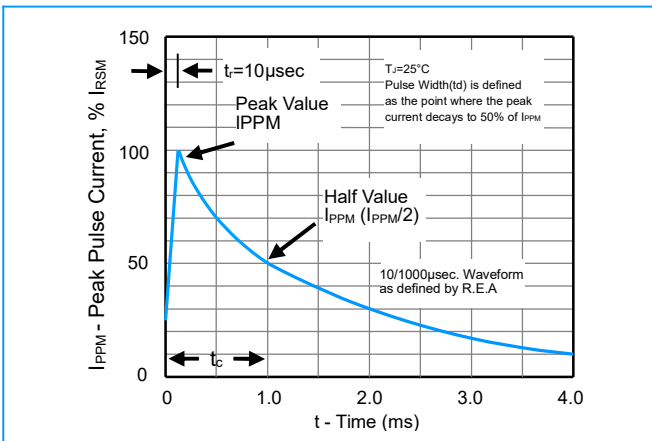

**Figure 4 - Typical Junction Capacitance**

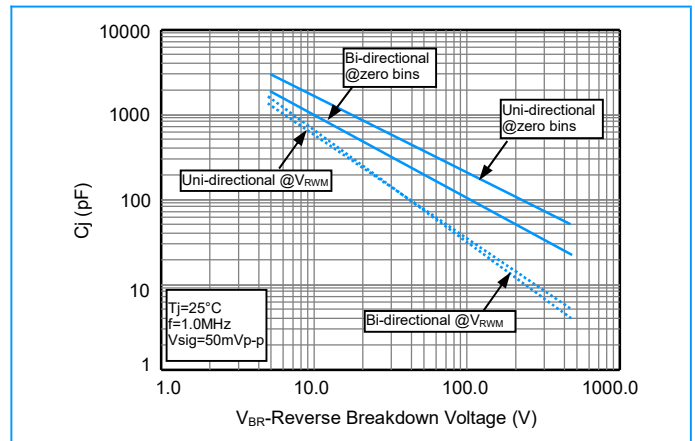

**Figure 5 - Steady State Power Derating Curve**

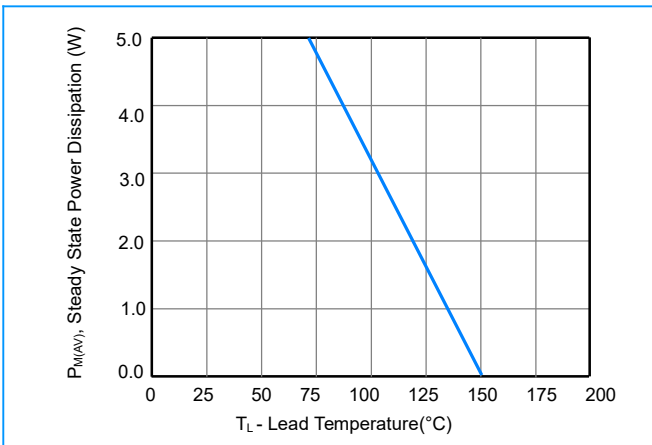

**Figure 6 - Maximum Non-Repetitive Surge Current**

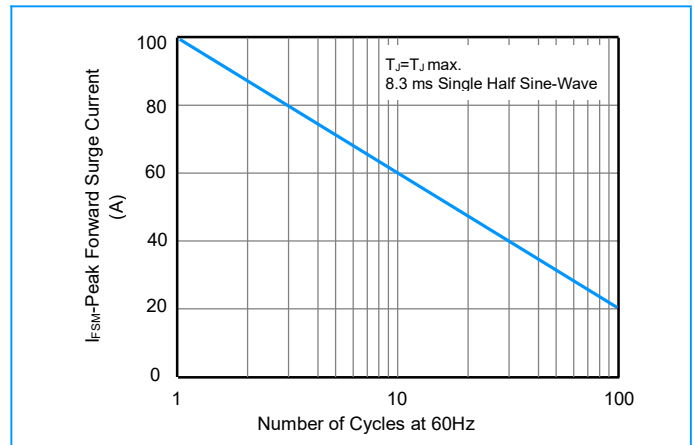

# Surface Mount Transient Voltage Suppressors (TVS)

**SMBJ Series 5.0 To 440 V 600W**

## I-V Curve Characteristics

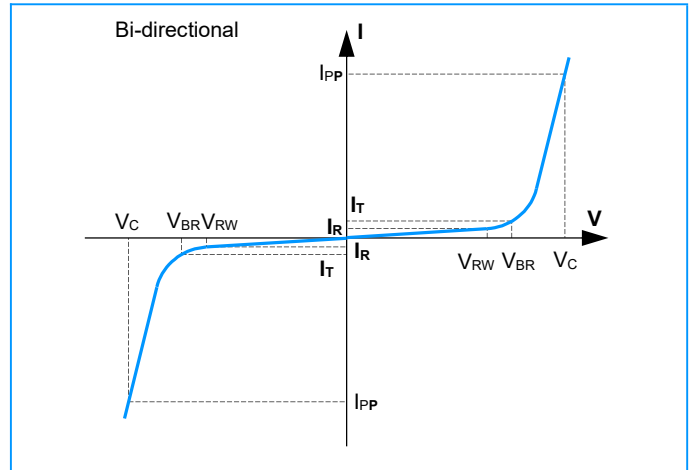
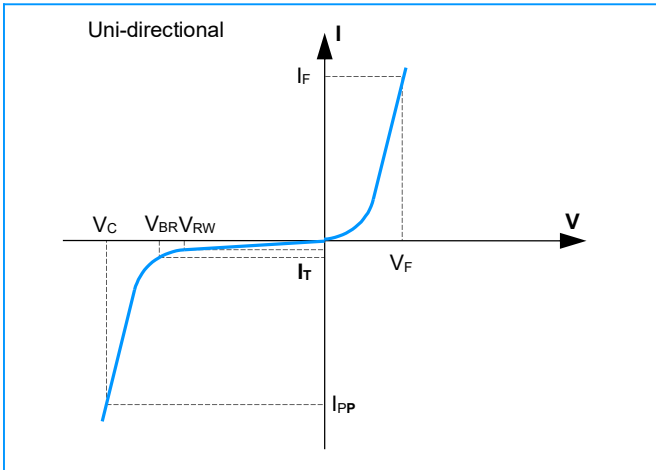

## Physical Specifications

<b>Weight</b>	0.003 ounce, 0.093 gram
<b>Case</b>	JEDEC DO-214AA Molded Plastic over glass passivated junction
<b>Polarity</b>	Color band denotes cathode except Bipolar
<b>Terminal</b>	Matte Tin-plated leads, Solderable per JESD22-B102D

## Environmental Specifications

<b>Temperature Cycle</b>	JESD22-A104
<b>Pressure Cooker</b>	JESD22-A102
<b>High Temp. Storage</b>	JESD22-A103
<b>HTRB</b>	JESD22-A108
<b>Thermal Shock</b>	JESD22-A106

## Soldering Parameters

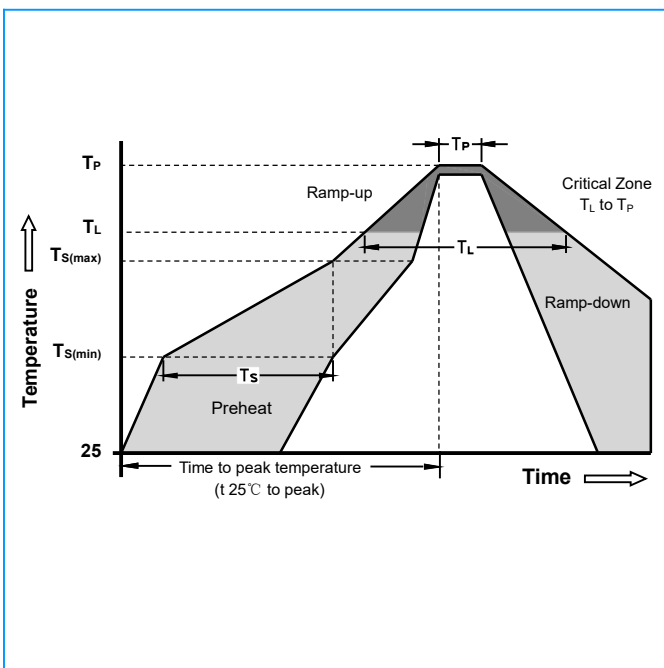

Reflow Condition		Lead-free assembly
Pre Heat	-Temperature Min ( $T_{S(min)}$ )	150°C
	-Temperature Max ( $T_{S(max)}$ )	200°C
	- Time (min to max) ( $T_S$ )	60 -180 Seconds
Average ramp up rate ( Liquidus Temp $T_L$ ) to peak		3°C/second max
$T_{S(max)}$ to $T_L$ - Ramp-up Rate		3°C/second max
Reflow	- Temperature ( $T_L$ ) (Liquidus)	217°C
	- Time (min to max) ( $T_L$ )	60 -150 Seconds
Peak Temperature ( $T_P$ )		260 +0/-5°C
Time within 5°C of actual peak Temperature ( $t_p$ )		20 -40 Seconds
Ramp-down Rate		6°C/second max
Time 25°C to peak Temperature ( $T_P$ )		8 minutes Max
Do not exceed		280°C

# Surface Mount Transient Voltage Suppressors (TVS)

**SMBJ Series 5.0 To 440 V 600W**

## Dimensions

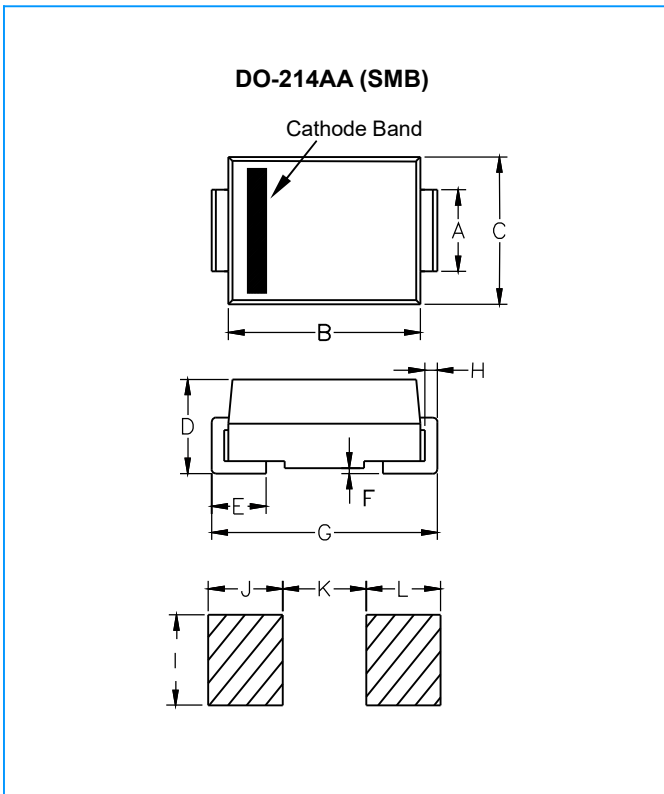

Dimensions	Inches		Millimeters	
	Min	Max	Min	Max
A	0.073	0.087	1.85	2.21
B	0.167	0.191	4.25	4.85
C	0.130	0.155	3.30	3.94
D	0.085	0.104	2.15	2.65
E	0.030	0.060	0.75	1.52
F	--	0.008	--	0.203
G	0.200	0.220	5.08	5.59
H	0.006	0.012	0.15	0.31
I	0.089	-	2.26	-
J	0.085	-	2.10	-
K	-	0.107	-	2.74
L	0.085	-	2.10	-

## Part Numbering

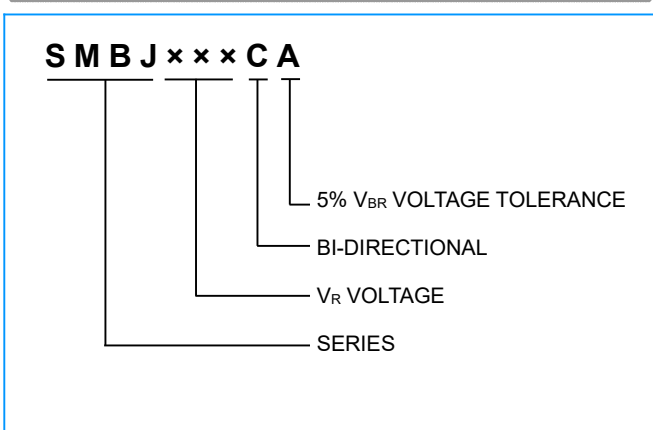

## Part Marking

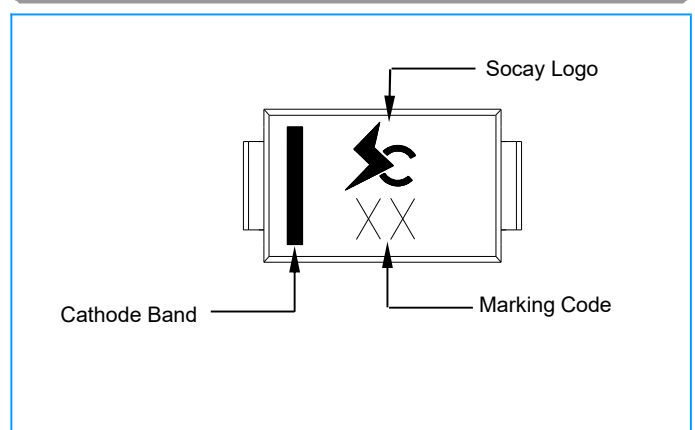

## Surface Mount Transient Voltage Suppressors (TVS)

**SMBJ Series 5.0 To 440 V 600W**

### Packaging

Part Number	Component Package	Reel (PCS)	Per Carton (PCS)	Packaging Option	Reel Diameters (mm)
SMBJXXXXX	DO-214AA (SMB)	3000	48000	Tape & Reel -15mm/13"tape	330.0

### Tape and Reel Specifications

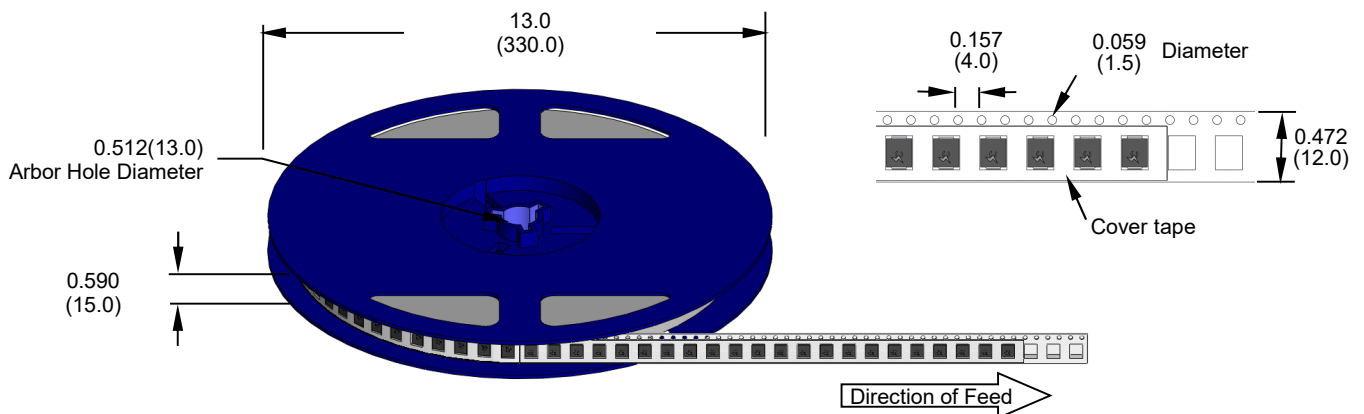

Dimensions are in inches  
(and millimeters)