

Features:

- Long operating life
- Low Power Consumption
- Wide Viewing Angle
- Low voltage DC operated
- RoHS Compliant
- Moisture sensitivity level: 3

Application:

- Backlight
- Decoration lighting
- motormeter
- Indicator

| Part Number | Dice Material | Emitted Color | Lens Color |
|-----------------|---------------|---------------|-------------|
| E6C0805VGAC1UDA | InGaN | Green | Water Clear |

Electro-Optical Characteristics ($T_a=25^{\circ}\text{C}$, @20mA)

| Parameter | Symbol | Min. | Typ. | Max. | Unit |
|---------------------|---------------------------|------|------|------|------|
| Luminous Intensity | IV | 400 | - | 800 | mcd |
| Radiation Bandwidth | $\Delta\lambda$ | - | 35 | - | nm |
| Forward Voltage | V _F | 2.90 | 3.00 | 3.40 | v |
| Luminous Flux | Φ | - | - | - | Lm |
| Dominant Wavelength | λ_d | 515 | 520 | 527 | nm |
| CIE Coordinates CIE | x,y | - | - | - | - |
| Color Temperature | T _c | - | - | - | k |
| Viewing Angle | 2 θ _{1/2} | - | 120 | - | deg |
| Reverse Current | I _R | - | - | 10 | uA |

Absolute Maximum Ratings ($T_a=25^{\circ}\text{C}$)

| Parameter | Symbol | Max. | Unit |
|--|------------------|------------------|------|
| Peak Forward Current(1/10 Duty Cycle, 0.1ms Pulse Width) | I _{PF} | 100 | mA |
| Forward Current | I _F | 30 | mA |
| Reverse Voltage | V _R | 5 | v |
| Electrostatic Discharge | ESD | 2000 | v |
| Operating Temperature Range | T _{opr} | -40to+90 | °C |
| Storage Temperature Range | T _{stg} | -40to+90 | °C |
| Reflow Soldering | T _{sld} | 260°C for 10secs | |



Optical & Electrical Characteristics

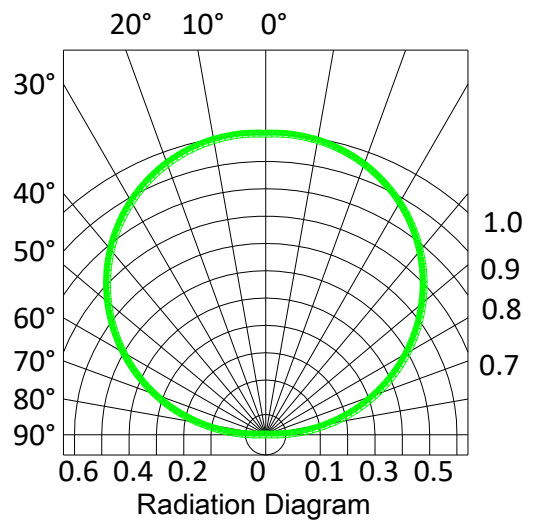
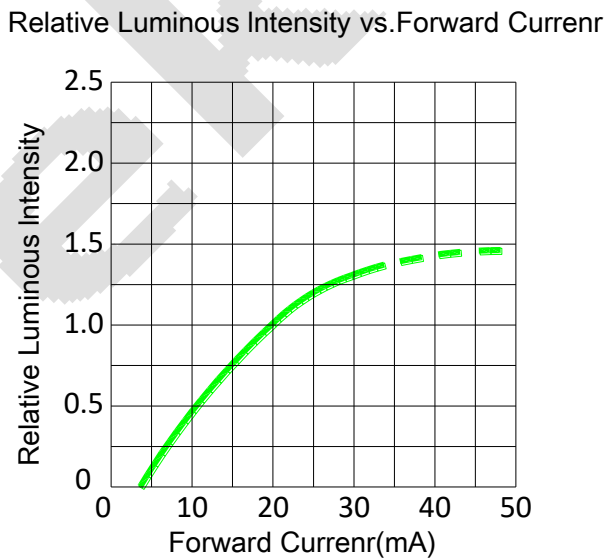
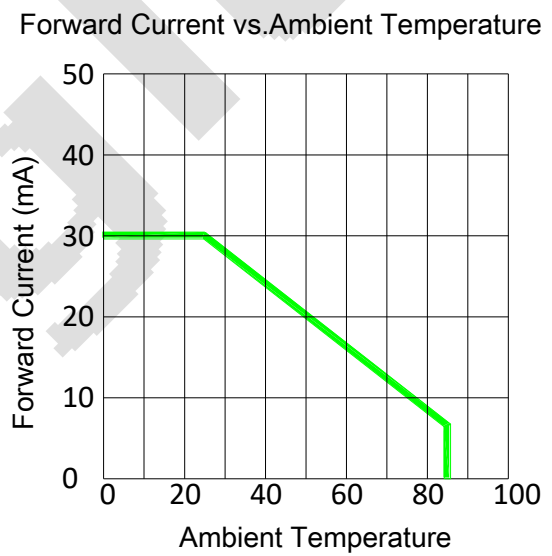
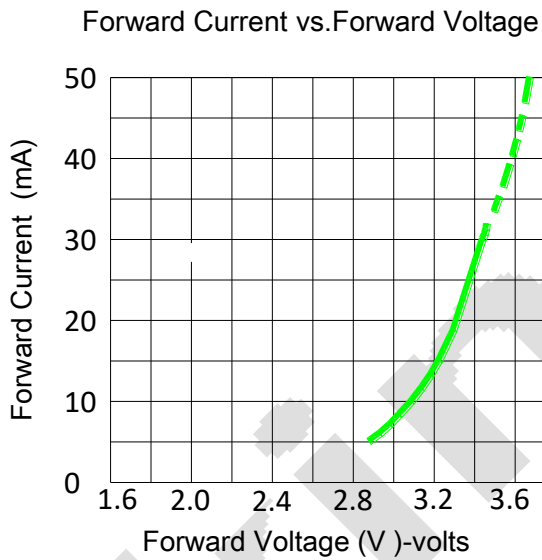
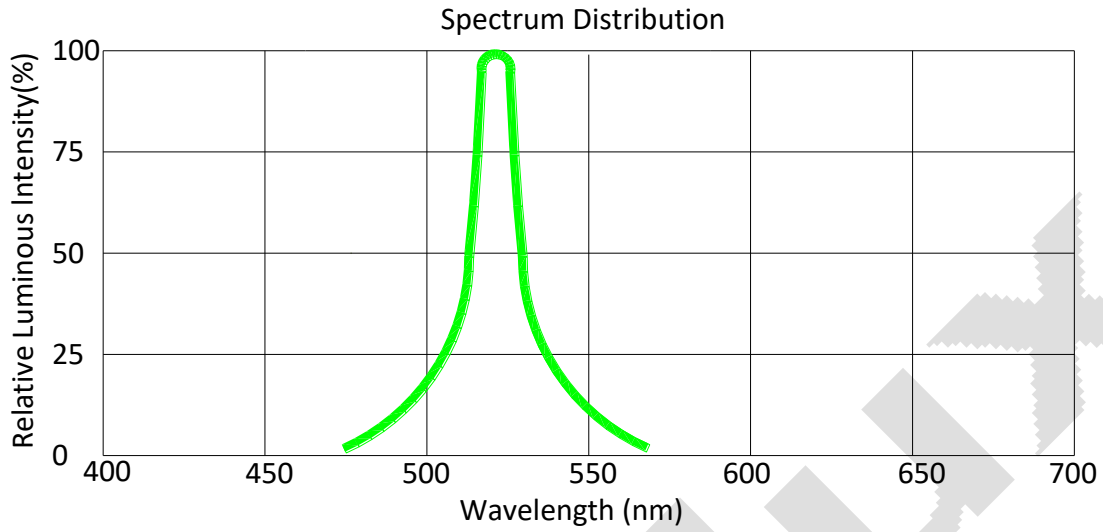



Bin Limits

Bin Range Of Luminous Intensity (Unit:mcd)

| Bin Code | Min | Max | Condition |
|----------|-----|-----|-----------|
| L1 | 400 | 600 | IF=20mA |
| L2 | 600 | 800 | |
| L3 | - | - | |

Bin Range Of Forward Voltage (Unit:V)

| Bin Code | Min | Max | Condition |
|----------|-----|-----|-----------|
| V1 | 2.9 | 3.0 | IF=20mA |
| V2 | 3.0 | 3.1 | |
| V3 | 3.1 | 3.2 | |
| V4 | 3.2 | 3.3 | |
| V5 | 3.3 | 3.4 | |

Bin Range Of Wavelength (Unit:nm)

| Bin Code | Min | Max | Condition |
|----------|-----|-----|-----------|
| G1 | 515 | 517 | IF=20mA |
| G2 | 517 | 519 | |
| G3 | 519 | 521 | |
| G4 | 521 | 523 | |
| G5 | 523 | 525 | |
| G6 | 525 | 527 | |

Notes:

- 1.Tolerance of Luminous Intensity $\pm 10\%$
- 2.Tolerance of Forward Voltage $\pm 0.1V$

Reliability Test Items And Conditions

| Test Items | Reference | Test Conditions | Time | Quantity | Criterion |
|---|----------------------------|---------------------------------|---------------|----------|-----------|
| Thermal Shock | MIL-STD-202G | -40°C (30min) -100°C (30min) | 100 Cycles | 22 | 0/22 |
| Temperature And Humidity Cyclic | JEITA ED-4701 200 203 | -10°C~65°C ; 0%~90%RH | 10cycles | 22 | 0/22 |
| High Temperature Storage | JEITA ED -4071 200 201 | Ta=100°C | 1000H | 22 | 0/22 |
| Low Temperature Storage | JEITA ED -4071 200 202 | Ta=-40°C | 1000H | 22 | 0/22 |
| High Temperature High Humidity Storage | JEITA ED -4071 100 103 | Ta=60°C ; RH=90% | 1000H | 22 | 0/22 |
| High Temperature Life Test | JESD22-A108D | Ta=80°C | 1000H | 22 | 0/22 |
| Life Test | JESD22-A108D | Ta=25°C IF=20mA | 1000H | 22 | 0/22 |
| Resistance to Soldering Heat | GB/T 4937, II , 2.2&2.3 | Tsol*=(240±5) °C 10secs | 2 times | 22 | 0/22 |

Criteria For Judging Damage

| Test Items | Symbol | Test Conditions | Criteria For Judging Damage |
|---------------------------------|----------------|---------------------------------|---|
| Forward Voltage | V _F | I _F =I _{FT} | Initial Data±10% |
| Reverse Current | I _R | V _R =5V | I _R ≤10uA |
| Luminous Intensity | I _V | I _F =I _{FT} | Average I _V degradation≤30% ; Single LED I _V degradation≤50% |
| Resistance to Soldering Heat | - | - | Material without internal cracks,no material between stripped,no dead light |

Product size (Unit:mm)

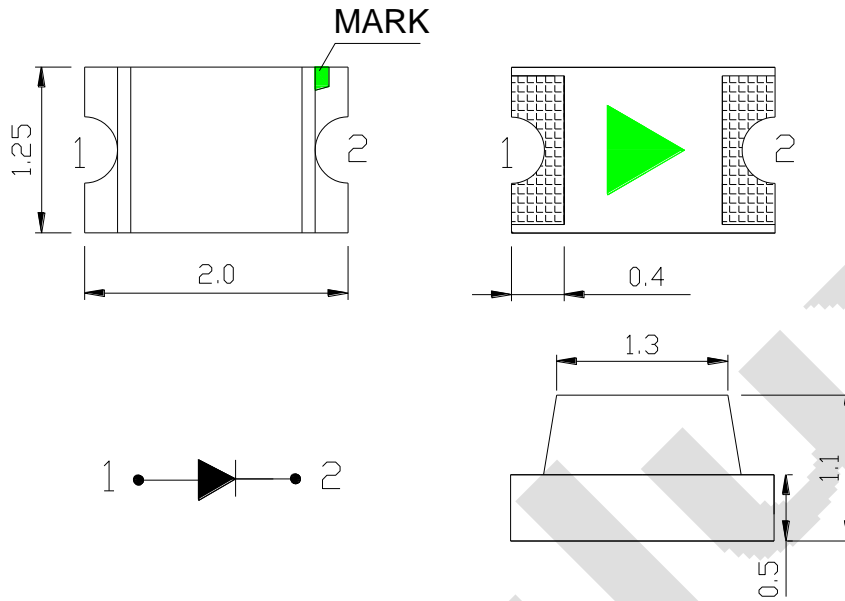

NOTES :

1. All dimensions are in millimeters (inches)
2. Tolerances are $\pm 0.2\text{mm}$ (0.008inch) unless otherwise noted

Recommended Soldering Pad Design (Unit:mm)

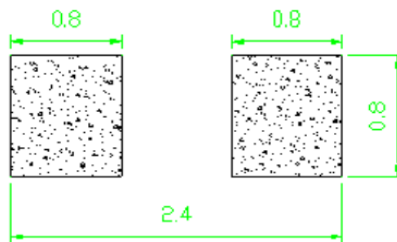

Taping and package Spec

- Tape Specification:3,000pcs Per Reel

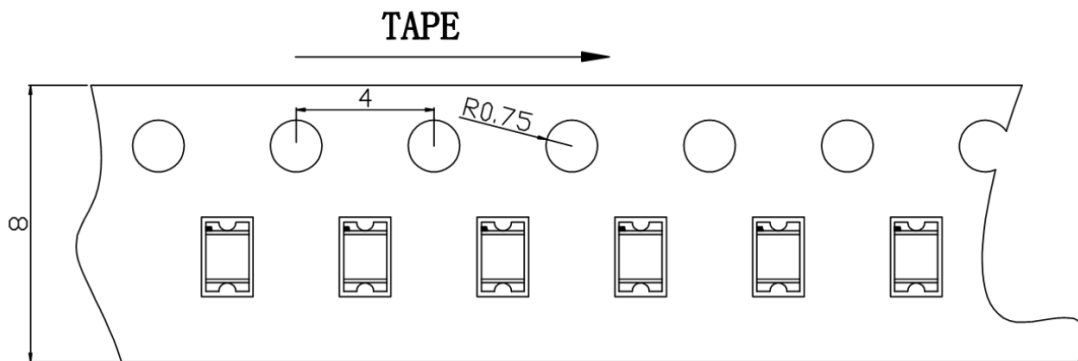

Packaging

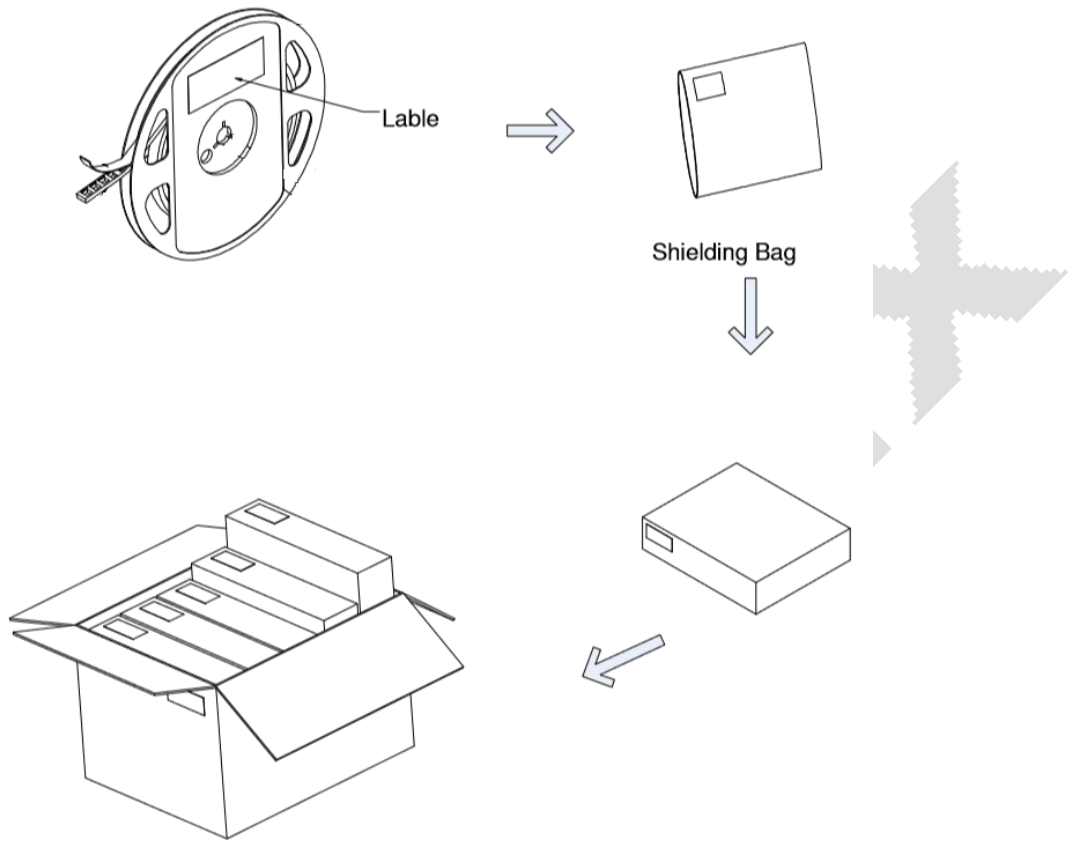

LabelStyle

EKINGLUX OPTOELECTRONICS(SHANGHAI) CO.,LTD



P/N:E6C1206QBAC1UDA

Emitting Color: Blue

HUE: 466-468 nm

IV :100-150 mcd

VF: 3.0-3.2 V *example* BIN Code: 2

QTY: 3000 PCS DATE: 2018/06/06



LOT NO.:1806103



RoHS
COMPLIANT

Pb
Pb-Free



Useful hint

Reflow Soldering Instructions

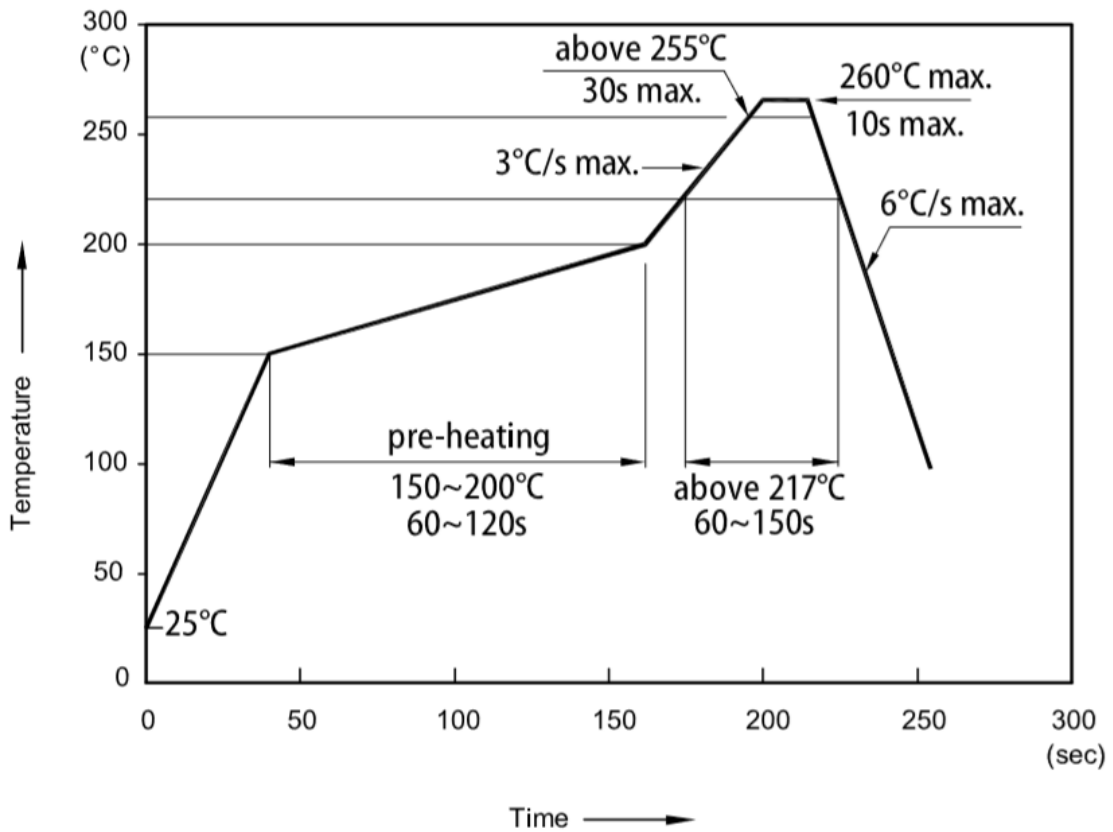

1. Don't cause stress to the LEDs while it is exposed to high temperature.
2. The maximum number of reflow soldering passes is 2 times.
3. Reflow soldering is recommended. Other soldering methods are not recommended as they might cause damage to the product.

Precautions

1. Storage:

- Moisture proof and anti-electrostatic package with moisture absorbent material is used, to keep moisture to a minimum.
- Before opening the package, the product should be kept at 30°C or less and humidity less than 60% RH, and be used within a year.
- After opening the package, the product should be stored at 30°C or less and humidity less than 10%RH, and be soldered within 24 hours (1day). It is recommended that the product be operated at the workshop condition of 30°C or less and humidity less than 60%RH.
- If the moisture absorbent material has faded away or the LEDs have exceeded the storage time, baking treatment should be performed based on the following condition: (70±5)°C for 24 hours.

2. Static Electricity:

Static electricity or surge voltage damages the LEDs. Damaged LEDs will show some unusual characteristics such as the forward voltage becoming lower, or the LEDs do not light at the low current, even not light.

All devices, equipment and machinery must be properly grounded. At the same time, it is recommended that wrist bands or anti-electrostatic gloves, anti-electrostatic containers be used when dealing with the LEDs.

3. Vulcanization:

LED curing is due to sulfur being in brackets and the +1 price of silver in the chemical reaction generated Ag₂S in the process. It will lead to the capacity of reflecting of silver layer reducing, light color temperature drift and serious decline, seriously affecting the performance of the product. So we should take corresponding measures to avoid vulcanization, such as to avoid using sulphur volatile substances and keeping away from high sulphur content of the material.