

N-Channel 30-V(D-S) MOSFET

$V_{(BR)DSS}$	$R_{DS(on)MAX}$	I_D
30V	0.025Ω@10V	5.8A
	0.035Ω@4.5V	

General FEATURE

- TrenchFET Power MOSFET
- Lead free product is acquired
- Surface mount package

APPLICATION

- Load Switch for Portable Devices
- DC/DC Converter

SOT-23

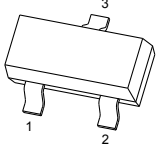

1.GATE
2.SOURCE
3.DRAIN

MARKING



A46TF w

*w: week code

Equivalent Circuit

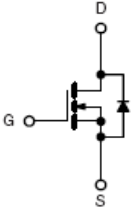

Maximum ratings ($T_a=25^{\circ}\text{C}$ unless otherwise noted)

Parameter	Symbol	Value	Unit
Drain-Source Voltage	V_{DS}	30	V
Gate-Source Voltage	V_{GS}	±20	
Continuous Drain Current	I_D	5.8	A
Pulsed Drain Current*1	I_{DM}	20	
Continuous Source-Drain Diode Current	I_S	1.0	
Maximum Power Dissipation	P_D	1.4	W
Thermal Resistance from Junction to Ambient($t \leq 10\text{s}$)	$R_{\theta JA}$	89	$^{\circ}\text{C/W}$
Junction Temperature	T_J	-55 ~+150	$^{\circ}\text{C}$
Storage Temperature	T_{stg}	-55 ~+150	

Note :

*1. Pulse Width $\leq 300\mu\text{s}$, Duty cycle $\leq 2\%$

MOSFET ELECTRICAL CHARACTERISTICS

T_a =25 °C unless otherwise specified

Parameter	Symbol	Test Condition	Min	Typ	Max	Units
Static						
Drain-source breakdown voltage	V _{(BR)DSS}	V _{GS} = 0V, I _D = 250μA	30	-	-	V
Gate-source threshold voltage	V _{GS(th)}	V _{DS} =V _{GS} , I _D = 250μA	1.2	1.6	2.4	
Gate-source leakage	I _{GSS}	V _{DS} =0V, V _{GS} =±20V	-	-	±100	nA
Zero gate voltage drain current	I _{DSS}	V _{DS} =24V, V _{GS} =0V	-	-	100	nA
Drain-source on-state resistance ^a	R _{DS(on)}	V _{GS} =10V, I _D =5.8A	-	0.023	0.025	Ω
		V _{GS} =4.5V, I _D =5A	-	0.032	0.035	
Forward transconductance ^a	g _{fs}	V _{DS} =5V, I _D =5A	-	15	-	S
Dynamic^b						
Input capacitance	C _{iss}	V _{DS} =15V, V _{GS} =0V, f =1MHz	-	255	-	pF
Output capacitance	C _{oss}		-	45	-	
Reverse transfer capacitance	C _{rss}		-	35	-	
Total gate charge	Q _g	V _{DS} =15V, V _{GS} =10V, I _D =5.0A	-	5.2	-	nC
Gate-source charge	Q _{gs}		-	0.85	-	
Gate-drain charge	Q _{gd}		-	1.3	-	
Turn-on delay time	t _{d(on)}	V _{DD} =15V, R _L =3Ω V _{GS} =10V, R _{gen} =3Ω	-	4.5	-	ns
Rise time	t _r		-	2.5	-	
Turn-off delay time	t _{d(off)}		-	14.5	-	
Fall time	t _f		-	3.5	-	
Drain-source body diode characteristics						
Continuous source-drain diode current	I _S	T _C =25°C	-	-	2.5	A
Body diode voltage	V _{SD}	I _S =1.0A	-	0.7	1.0	V

Notes :

a. Pulse Test : Pulse Width < 300μs, Duty Cycle ≤2%.

b. Guaranteed by design, not subject to production testing.

Typical Electrical and Thermal Characteristics

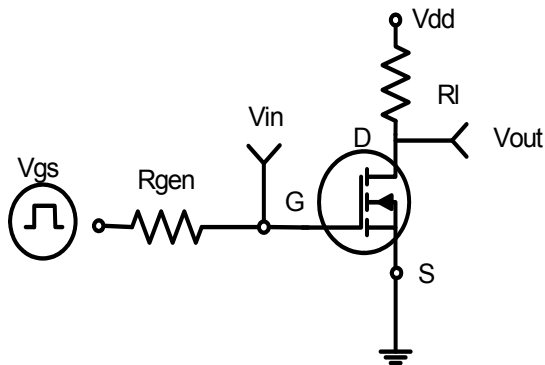

Figure 1: Switching Test Circuit

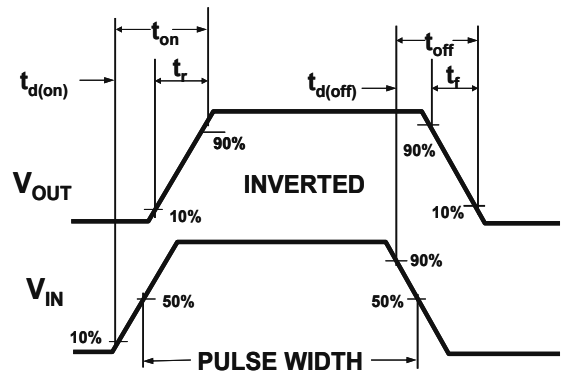

Figure 2: Switching Waveforms

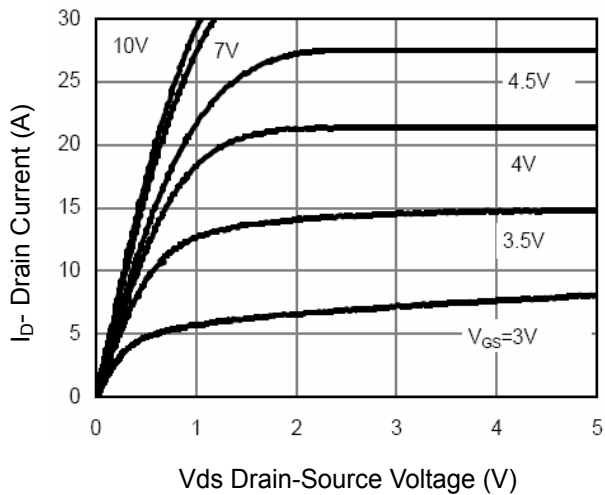

Figure 3 Output Characteristics

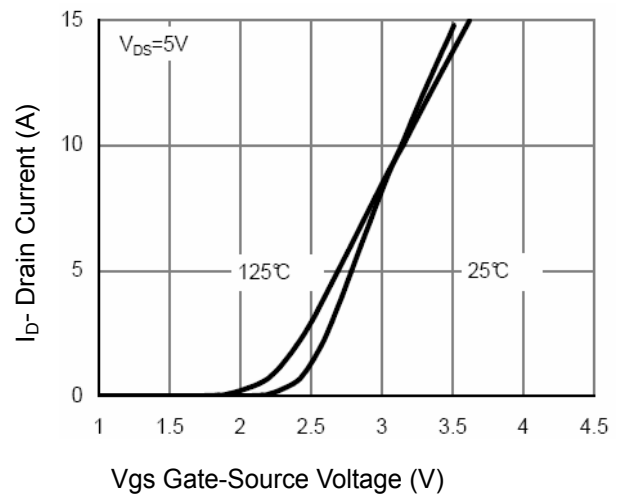

Figure 4 Transfer Characteristics

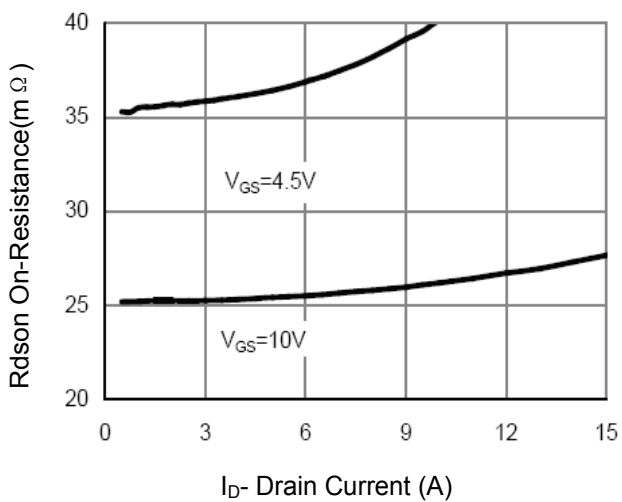

Figure 5 Drain-Source On-Resistance

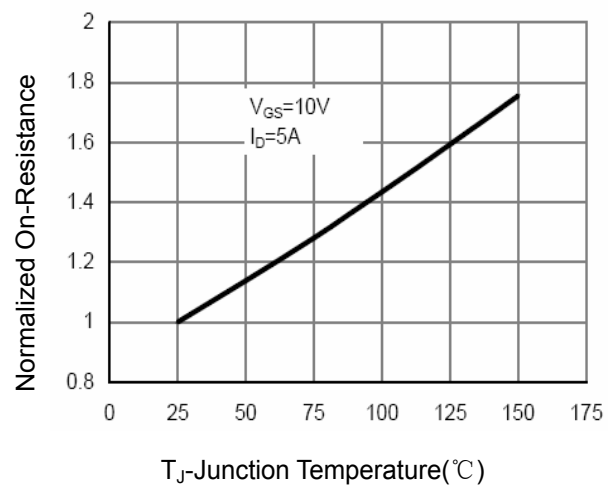

Figure 6 Drain-Source On-Resistance

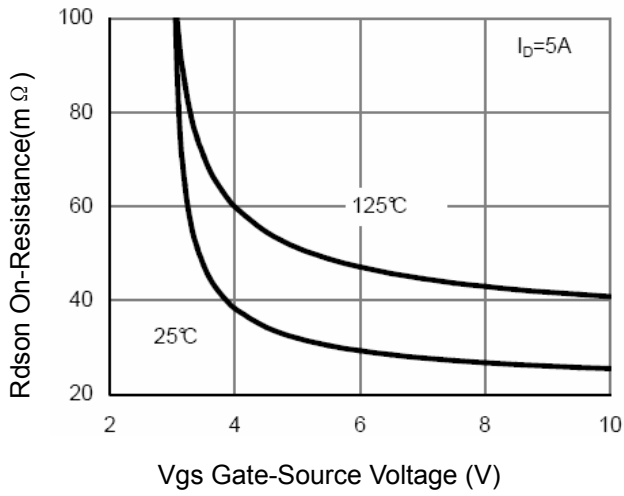

Figure 7 Rdson vs Vgs

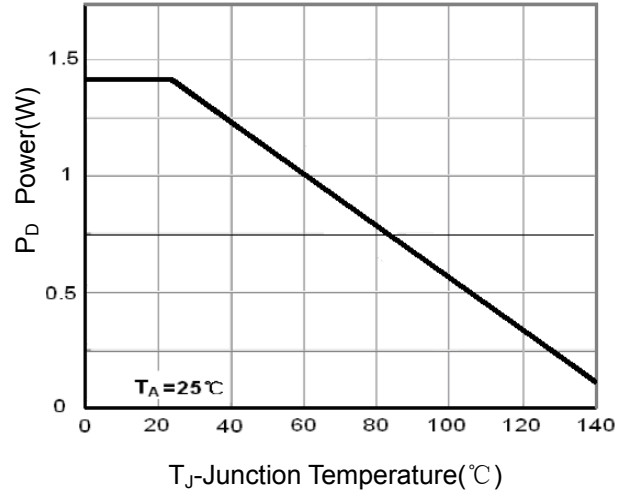

Figure 8 Power Dissipation

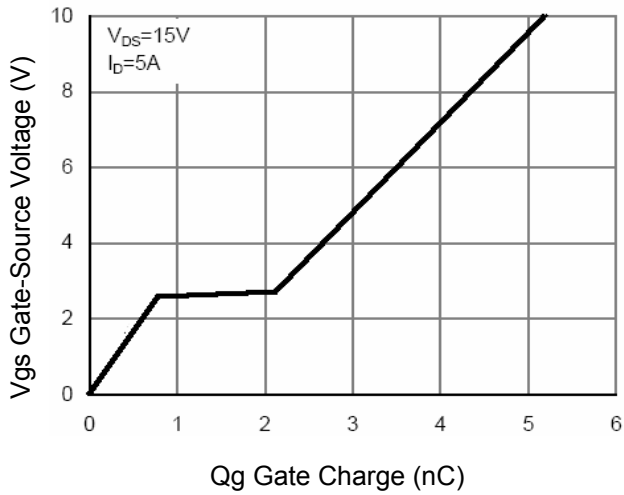

Figure 9 Gate Charge

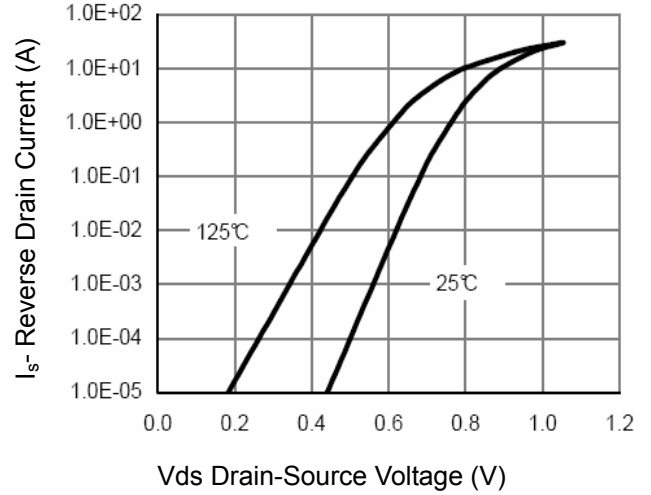

Figure 10 Source- Drain Diode Forward

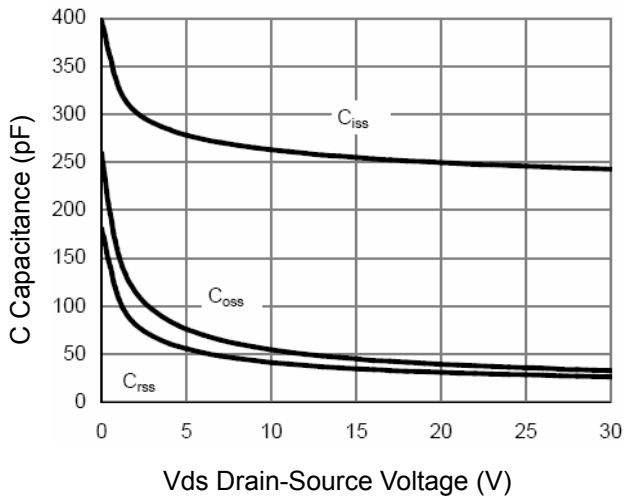

Figure 11 Capacitance vs Vds

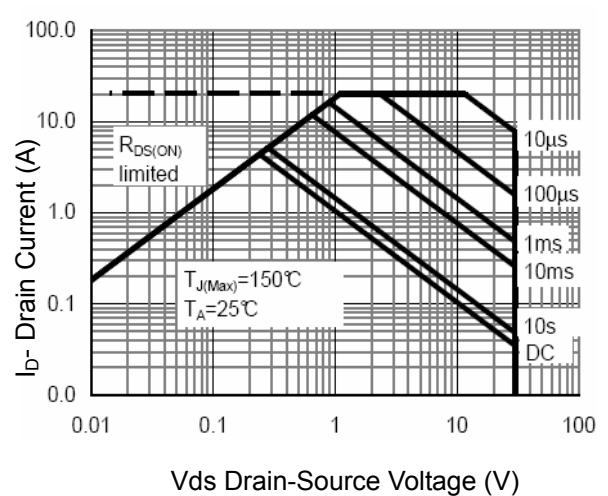

Figure 12 Safe Operation Area

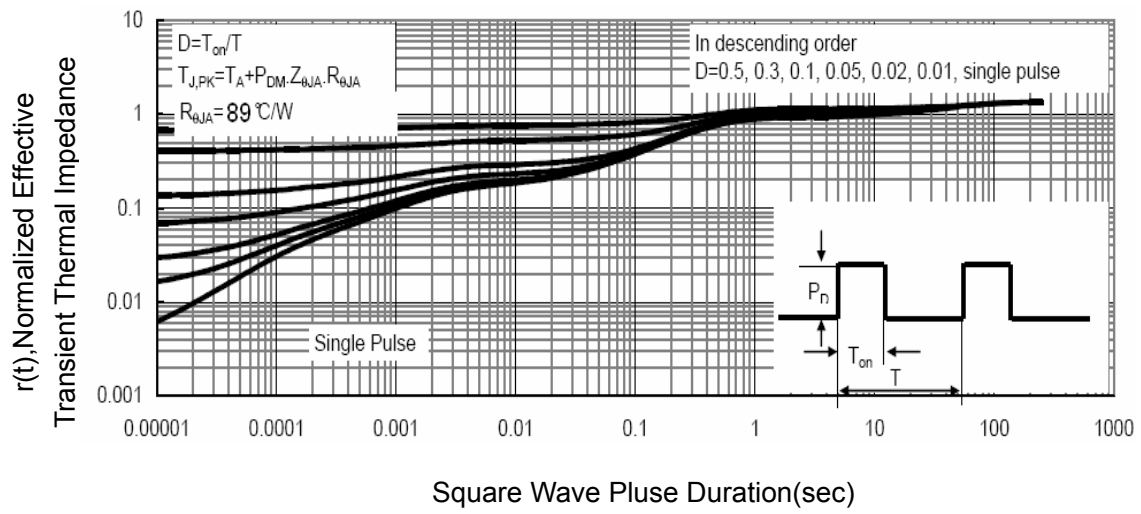
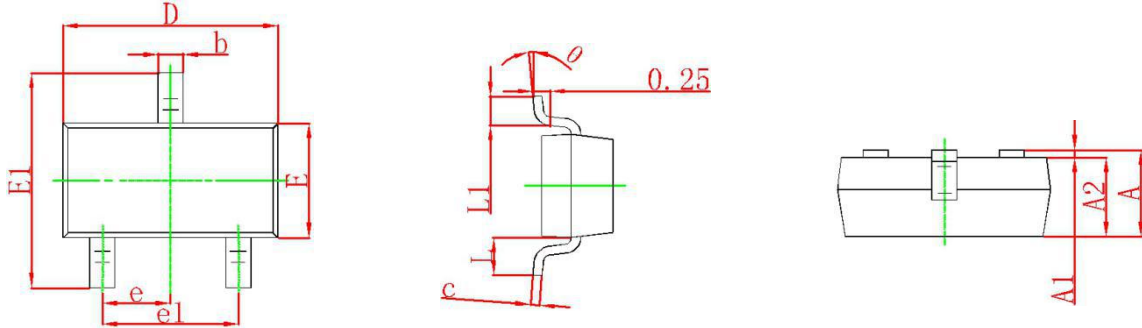

Figure 13 Normalized Maximum Transient Thermal Impedance

SOT-23 Package Outline Dimensions



Symbol	Dimensions In Millimeters		Dimensions In Inches	
	Min	Max	Min	Max
A	0.900	1.150	0.035	0.045
A1	0.000	0.100	0.000	0.004
A2	0.900	1.050	0.035	0.041
b	0.300	0.500	0.012	0.020
c	0.080	0.150	0.003	0.006
D	2.800	3.000	0.110	0.118
E	1.200	1.400	0.047	0.055
E1	2.250	2.550	0.089	0.100
e	0.950 TYP		0.037 TYP	
e1	1.800	2.000	0.071	0.079
L	0.550 REF		0.022 REF	
L1	0.300	0.500	0.012	0.020
θ	0°	8°	0°	8°

SOT-23 Suggested Pad Layout

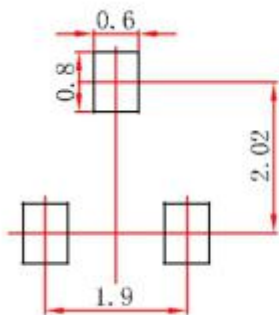

- Note:
1. Controlling dimension: in millimeters.
 2. General tolerance: $\pm 0.05\text{mm}$.
 3. The pad layout is for reference purposes only.