

N-Channel 20-V(D-S) MOSFET

$V_{(BR)DSS}$	$R_{DS(on)MAX}$	I_D
20V	0.022Ω@4.5V	6.5A
	0.026Ω@2.5V	
	0.034Ω@1.8V	

General FEATURE

- TrenchFET Power MOSFET
- Lead free product is acquired
- Surface mount package
- ESD Rating: 2000V HBM

APPLICATION

- Load Switch for Portable Devices
- DC/DC Converter

SOT-23

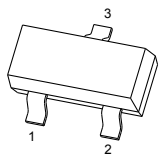

1.GATE
2.SOURCE
3.DRAIN

MARKING

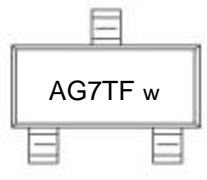

*w: week code

Equivalent Circuit

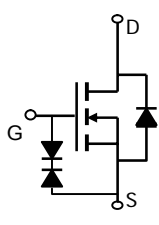

Absolute Maximum Ratings $T_A=25^{\circ}C$ unless otherwise noted

Parameter	Symbol	Maximum	Units	
Drain-Source Voltage	V_{DS}	20	V	
Gate-Source Voltage	V_{GS}	±10	V	
Continuous Drain Current ^A	$T_A=25^{\circ}C$	I_D	A	
Pulsed Drain Current ^B				30
Power Dissipation ^A	$T_A=25^{\circ}C$	P_D	1.4	W
Junction and Storage Temperature Range	T_J, T_{STG}	-55 to 150	$^{\circ}C$	

Thermal Characteristics

Parameter	Symbol	Typ	Max	Units
Maximum Junction-to-Ambient ^A	$R_{\theta JA}$	65	90	$^{\circ}C/W$
Maximum Junction-to-Ambient ^A		Steady-State	85	125
Maximum Junction-to-Lead ^C	$R_{\theta JL}$	43	60	$^{\circ}C/W$

Electrical Characteristics (T_J=25°C unless otherwise noted)

Symbol	Parameter	Conditions	Min	Typ	Max	Units
STATIC PARAMETERS						
BV _{DSS}	Drain-Source Breakdown Voltage	I _D =250μA, V _{GS} =0V	20			V
I _{DSS}	Zero Gate Voltage Drain Current	V _{DS} =16V, V _{GS} =0V			100	nA
I _{GSS}	Gate-Body leakage current	V _{DS} =0V, V _{GS} =±4.5V			±1	μA
		V _{DS} =0V, V _{GS} =±10V			±10	μA
V _{GS(th)}	Gate Threshold Voltage	V _{DS} =V _{GS} I _D =250μA	0.4	0.6	1	V
I _{D(ON)}	On state drain current	V _{GS} =4.5V, V _{DS} =5V	30			A
R _{DS(ON)}	Static Drain-Source On-Resistance	V _{GS} =4.5V, I _D =6.5A		18	22	mΩ
		V _{GS} =2.5V, I _D =5.5A		21	26	mΩ
		V _{GS} =1.8V, I _D =5A		26	34	mΩ
g _{FS}	Forward Transconductance	V _{DS} =5V, I _D =6.0A		29		S
V _{SD}	Diode Forward Voltage	I _S =1A, V _{GS} =0V		0.76	1	V
I _S	Maximum Body-Diode Continuous Current				2.5	A
DYNAMIC PARAMETERS						
C _{iss}	Input Capacitance	V _{GS} =0V, V _{DS} =10V, f=1MHz		1160		pF
C _{oss}	Output Capacitance			187		pF
C _{rss}	Reverse Transfer Capacitance			146		pF
R _g	Gate resistance	V _{GS} =0V, V _{DS} =0V, f=1MHz		1.5		Ω
SWITCHING PARAMETERS						
Q _g	Total Gate Charge	V _{GS} =4.5V, V _{DS} =10V, I _D =6.5A		16		nC
Q _{gs}	Gate Source Charge			0.8		nC
Q _{gd}	Gate Drain Charge			3.8		nC
t _{D(on)}	Turn-On DelayTime	V _{GS} =5V, V _{DS} =10V, R _L =1.5Ω, R _{GEN} =3Ω		6.2		ns
t _r	Turn-On Rise Time			12.7		ns
t _{D(off)}	Turn-Off DelayTime			51.7		ns
t _f	Turn-Off Fall Time			16		ns
t _{rr}	Body Diode Reverse Recovery Time	I _F =6.5A, dI/dt=100A/μs		17.7		ns
Q _{rr}	Body Diode Reverse Recovery Charge	I _F =6.5A, dI/dt=100A/μs		6.7		nC

A: The value of R_{θJA} is measured with the device mounted on 1in² FR-4 board with 2oz. Copper, in a still air environment with T_A=25°C. The value in any a given application depends on the user's specific board design. The current rating is based on the t_s ≤ 10s thermal resistance rating.

B: Repetitive rating, pulse width limited by junction temperature.

C: The R_{θJA} is the sum of the thermal impedance from junction to lead R_{θJL} and lead to ambient.

D: The static characteristics in Figures 1 to 6,12,14 are obtained using 80μs pulses, duty cycle 0.5% max.

E: These tests are performed with the device mounted on 1 in² FR-4 board with 2oz. Copper, in a still air environment with T_A=25°C. The SOA curve provides a single pulse rating.

TYPICAL ELECTRICAL AND THERMAL CHARACTERISTICS

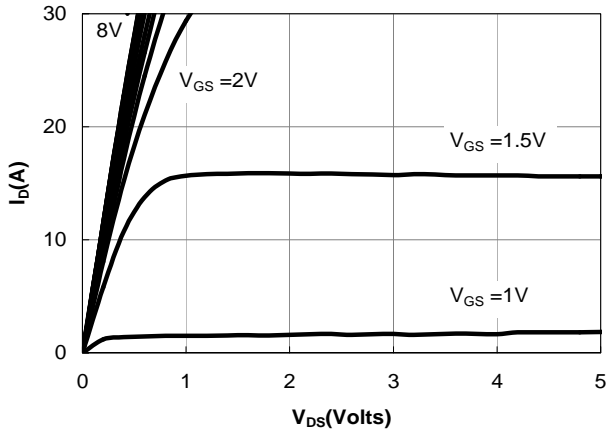

Figure 1: On-Regions Characteristics

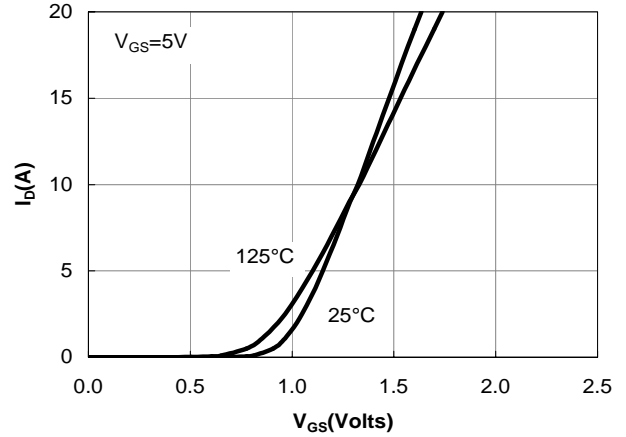

Figure 2: Transfer Characteristics

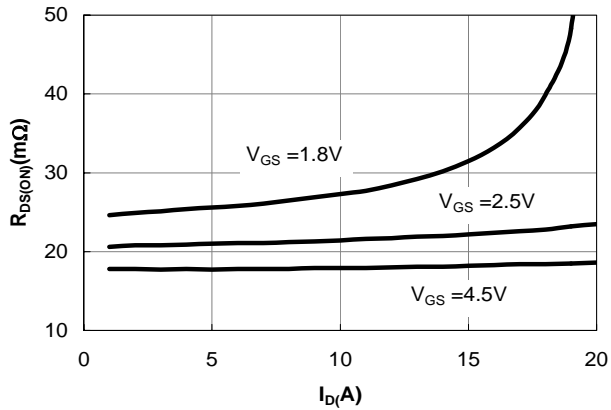

Figure 3: On-Resistance vs. Drain Current and Gate Voltage

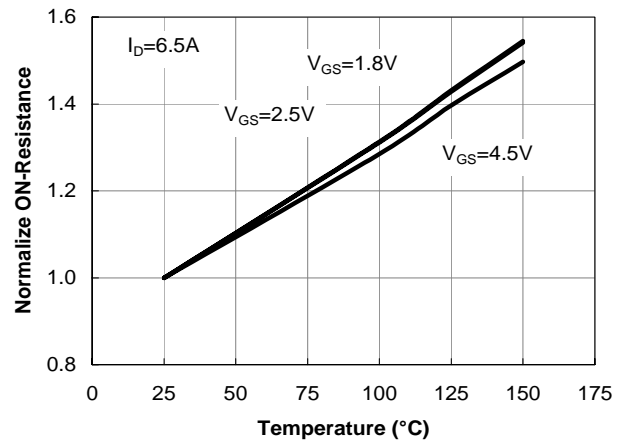

Figure 4: On-Resistance vs. Junction Temperature

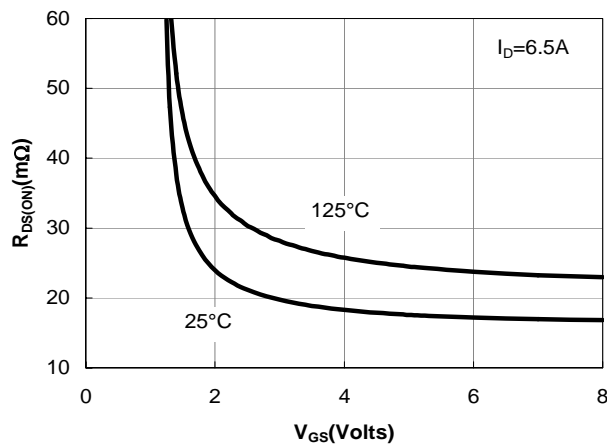

Figure 5: On-Resistance vs. Gate-Source Voltage

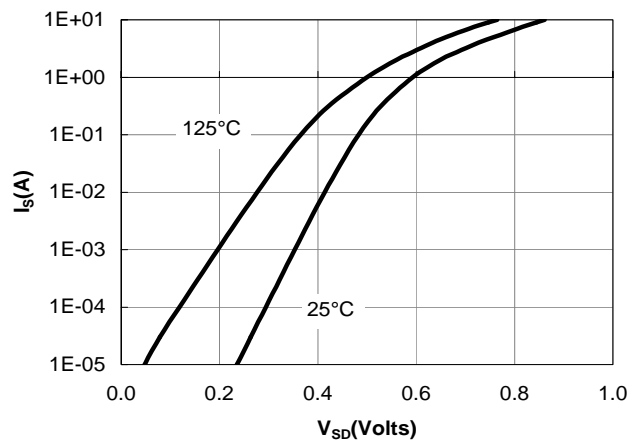

Figure 6: Body-Diode Characteristics

TYPICAL ELECTRICAL AND THERMAL CHARACTERISTICS

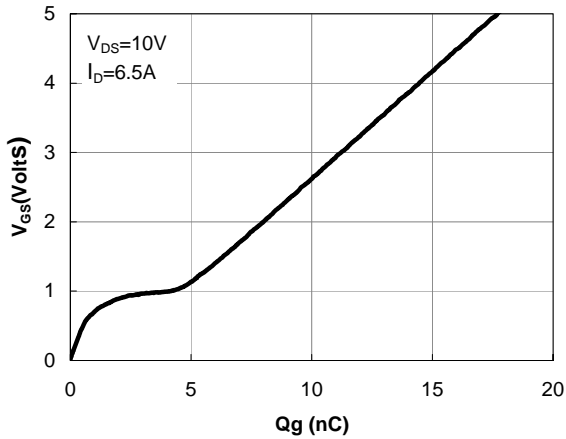

Figure 7: Gate-Charge Characteristics

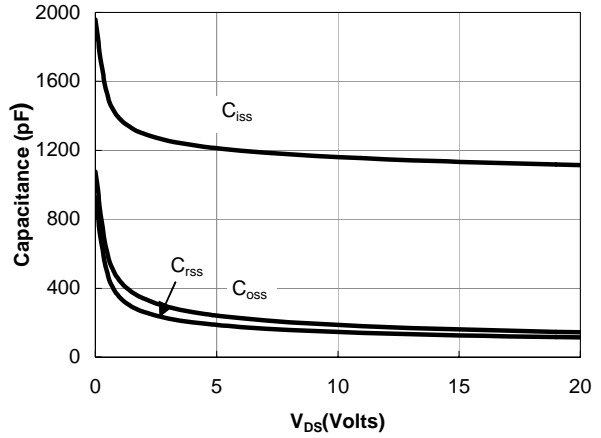

Figure 8: Capacitance Characteristics

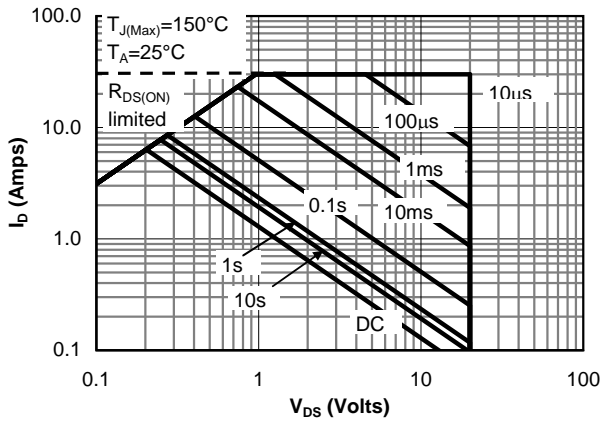

Figure 9: Maximum Forward Biased Safe Operating Area (Note E)

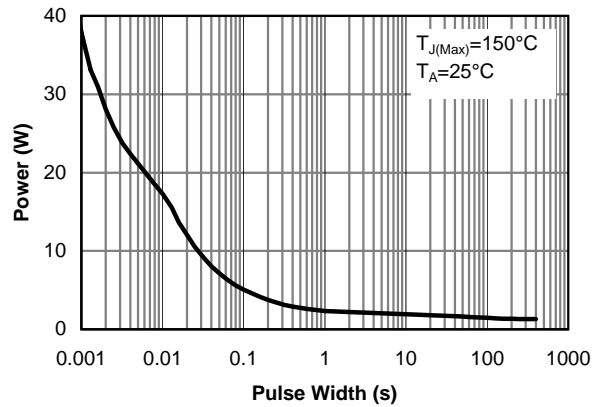

Figure 10: Single Pulse Power Rating Junction-to-Ambient (Note E)

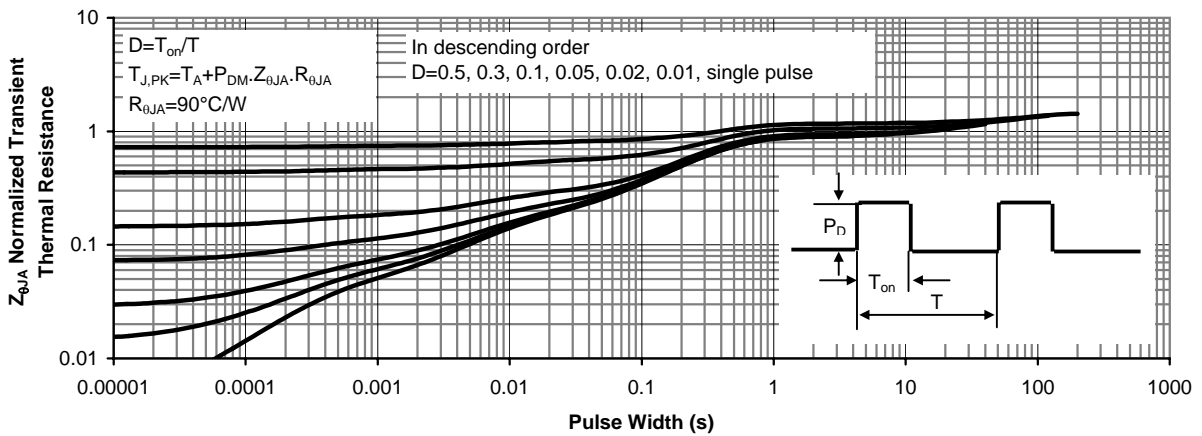
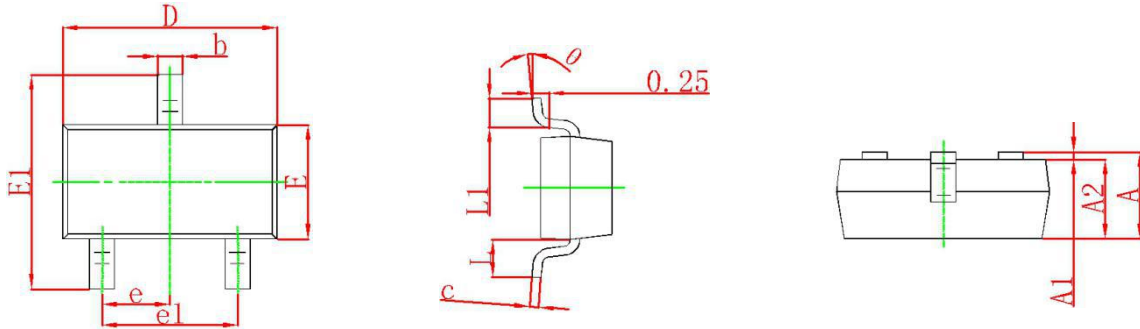

Figure 11: Normalized Maximum Transient Thermal Impedance

SOT-23 Package Outline Dimensions



Symbol	Dimensions In Millimeters		Dimensions In Inches	
	Min	Max	Min	Max
A	0.900	1.150	0.035	0.045
A1	0.000	0.100	0.000	0.004
A2	0.900	1.050	0.035	0.041
b	0.300	0.500	0.012	0.020
c	0.080	0.150	0.003	0.006
D	2.800	3.000	0.110	0.118
E	1.200	1.400	0.047	0.055
E1	2.250	2.550	0.089	0.100
e	0.950 TYP		0.037 TYP	
e1	1.800	2.000	0.071	0.079
L	0.550 REF		0.022 REF	
L1	0.300	0.500	0.012	0.020
θ	0°	8°	0°	8°

SOT-23 Suggested Pad Layout

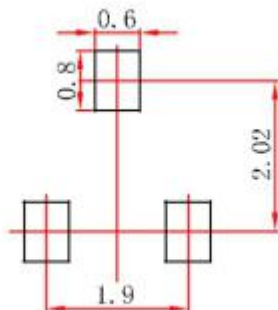

- Note:
1. Controlling dimension: in millimeters.
 2. General tolerance: $\pm 0.05\text{mm}$.
 3. The pad layout is for reference purposes only.