



# NAE12S20-C DC-DC Converter

## Technical Manual

Issue 01

Date 2020-01-07

HUAWEI TECHNOLOGIES CO., LTD.



# About This Document

## Purpose

This document describes the NAE12S20-C (EN42MCEC) in terms of its physical structure, electrical characteristics, and simple application.

The figures provided in this document are for reference only.





## Intended Audience

This document is intended for:

- Hardware engineers
- Software engineers
- System engineers
- Technical support engineers

## Symbol Conventions

The symbols that may be found in this document are defined as follows.

Symbol	Description
 <b>DANGER</b>	Indicates a hazard with a high level of risk which, if not avoided, will result in death or serious injury.
 <b>WARNING</b>	Indicates a hazard with a medium level of risk which, if not avoided, could result in death or serious injury.
 <b>CAUTION</b>	Indicates a hazard with a low level of risk which, if not avoided, could result in minor or moderate injury.
 <b>NOTICE</b>	Indicates a potentially hazardous situation which, if not avoided, could result in equipment damage, data loss, performance deterioration, or unanticipated results. NOTICE is used to address practices not related to personal injury.
 <b>NOTE</b>	Supplements the important information in the main text. NOTE is used to address information not related to personal injury, equipment damage, and environment deterioration.

## Change History

Changes between document issues are cumulative. The latest document issue contains all updates made in previous issues.

### **Issue 1.0 (2020-01-07)**

This issue is the first official release.

# Contents

<b>About This Document.....</b>	<b>i</b>
<b>1 Product Overview.....</b>	<b>1</b>
<b>2 Electrical Specifications.....</b>	<b>6</b>
2.1 Absolute Maximum Ratings.....	6
2.2 Input Characteristics.....	6
2.3 Output Characteristics.....	7
2.4 Protection.....	9
2.5 Dynamic Characteristics.....	10
2.6 Efficiency.....	11
2.7 Other Characteristics.....	14
<b>3 Characteristic Curves.....</b>	<b>15</b>
3.1 Efficiency and Power Dissipation Curves.....	15
3.2 Thermal Considerations.....	26
<b>4 Typical Waveforms.....</b>	<b>32</b>
4.1 Test Setup Diagram & Fundamental Circuit Diagram.....	32
4.2 Turn-on/Turn-off.....	33
4.3 Output voltage ripple.....	34
4.4 Output Voltage Dynamic Response.....	35
<b>5 Control Features.....</b>	<b>36</b>
5.1 Remote On/Off.....	36
5.2 Output Voltage Trim.....	37
5.3 Power Good Signal (PG).....	38
<b>6 Protection Features.....</b>	<b>39</b>
<b>7 Qualification Testing.....</b>	<b>40</b>
<b>8 EMC Specifications.....</b>	<b>43</b>
<b>9 Thermal Consideration.....</b>	<b>44</b>
<b>10 Package Information.....</b>	<b>45</b>
<b>11 Mechanical Consideration.....</b>	<b>47</b>

# 1 Product Overview

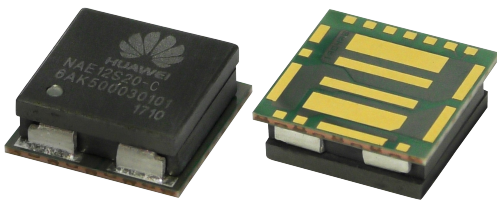

The NAE12S20-C is a Power System in Package (PSiP) DC-DC converter with an input voltage range of 3 V to 14 V and the maximum output current of 20 A. Its output voltage can be adjusted within a range of 0.6 V to 5.5 V.

#### Mechanical Features

- SMT
- Dimensions (L x W x H): 11.00 x 11.00 x 4.00 mm (0.43 x 0.43 x 0.16 in.)
- Weight: 1.6 g

#### Control Features

- Remote on/off
- Output voltage trim

#### Operational Features

- Input voltage: 3–14 V
- Output current: 0–20 A
- Output voltage: 0.6–5.5 V
- Efficiency: 92% ( $V_{in} = 5.4\text{ V}$ ,  $V_{out} = 1.8\text{ V}$ ,  $I_{out} = 10\text{ A}$ )

#### Protection Features

- Input undervoltage protection
- Output overcurrent protection (hiccup mode)
- Output short circuit protection (hiccup mode)
- Output overvoltage protection (self-recovery)
- Overtemperature protection (self-recovery)

#### Environmental Protection

- RoHS6 complaint, lead-free reflow soldering

#### Applications

- Servers
- Telecom and datacom
- Point of load regulation
- General purpose step-down DC/DC

### Model Naming Convention

NAE	12	S	20	-	C
1	2	3	4	-	5

- 1 — Non-isolated, analog, package type
- 2 — Input voltage: 12 V
- 3 — Single output
- 4 — Output current: 20 A
- 5 — Extension code

### Mechanical Diagram

Figure 1-1 Mechanical diagram

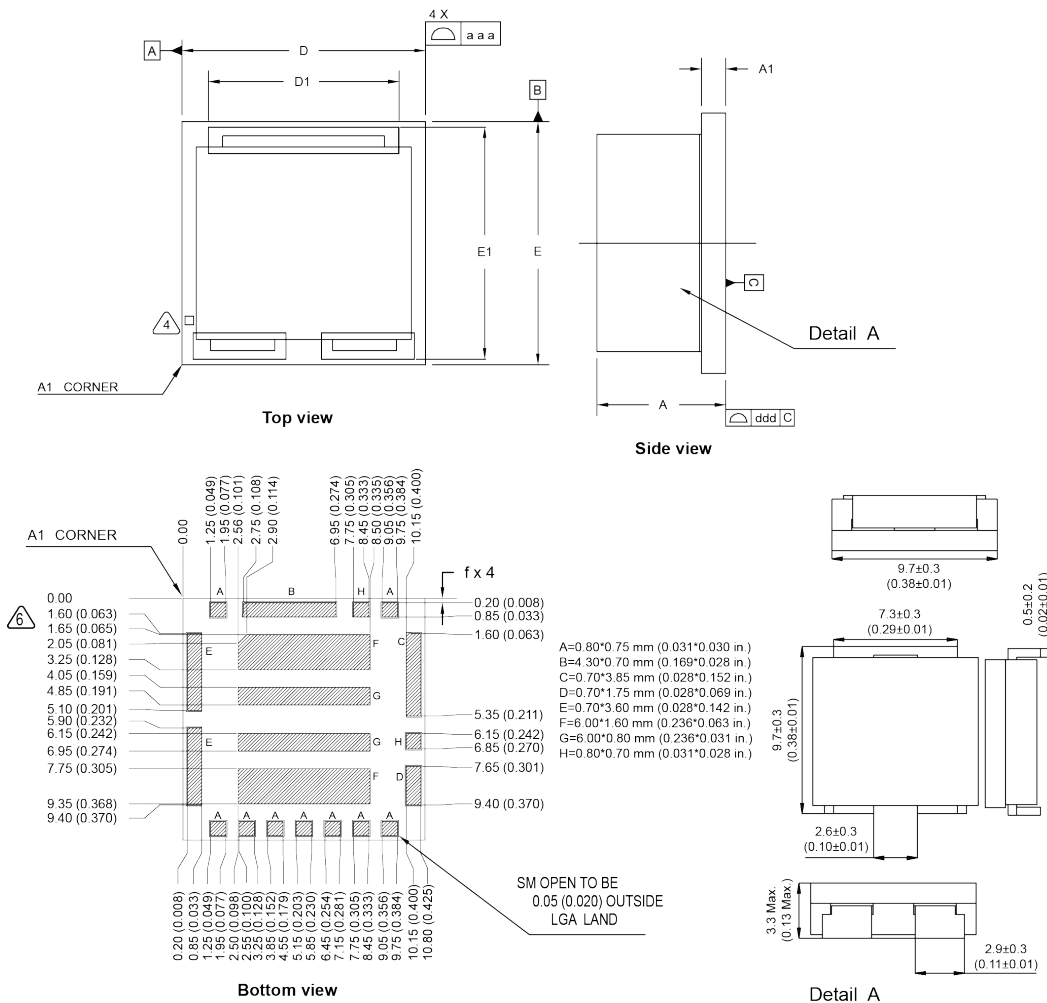

### NOTE

1.All dimensions are in the unit of mm [in.]. Tolerances: x.x ± 0.1 mm [x.xx ± 0.03 in.]; x.xx ± 0.05 mm [x.xxx ± 0.002 in.]; x.xxx ± 0.050 mm [x.xxx ± 0.002 in.].

2.Angle tolerance: ±1°.

Symbol	Min.	Normal	Max.
-	Dimensions in Millimeters (Inches)		
A	-	-	4.00 (0.16)
A1	0.520 (0.020)	0.577 (0.023)	0.634 (0.025)
D	10.90 (0.429)	11.00 (0.433)	11.10 (0.437)
D1	8.55 (0.337)	8.60 (0.339)	8.65 (0.340)
E	10.90 (0.429)	11.00 (0.433)	11.10 (0.437)
E1	10.45 (0.411)	10.50 (0.413)	10.55 (0.415)
f	0.10 (0.004)	0.15 (0.005)	0.20 (0.007)
aaa	0.08 (0.0031) BSC		
ddd	0.08 (0.0031) BSC		

**Figure 1-2** Pin Description

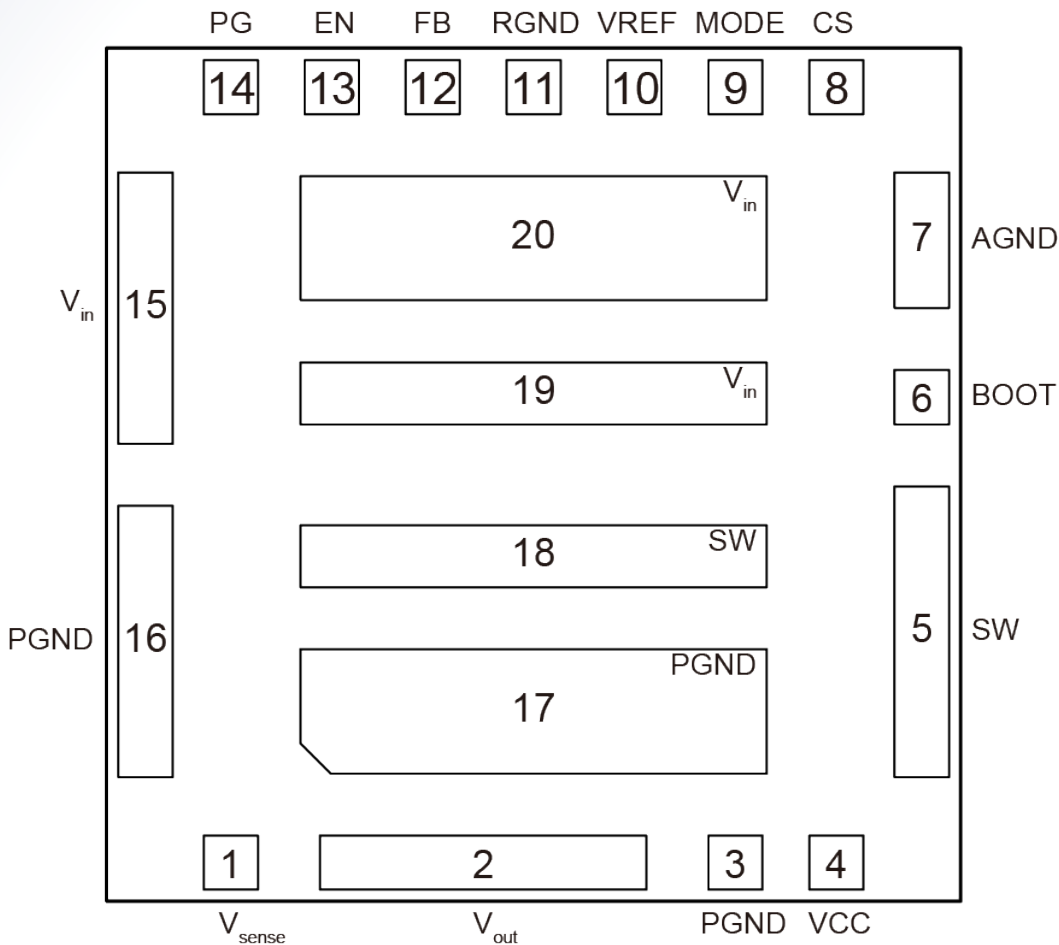

Pin No.	Name	Function
1	$V_{sense}$	Output voltage sense pin.
2	$V_{out}$	Output pin. Connect these pins to loads and place output filter capacitors between these pins and PGND pins.
3, 16, 17	PGND	Input and output power ground. Connect these pins to the ground electrode of the input and output filter capacitors.
4	VCC	Internal 3 V LDO output. The driver and control circuits are powered by this voltage. Decouple with a minimum 1 $\mu$ F ceramic capacitor as close to PGND as possible. X7R grade dielectric ceramic capacitors are recommended for their stable temperature characteristics.
5, 18	SW	Switching node of the circuit.
6	BOOT	Bootstrap. By default, this pin is left open.



Pin No.	Name	Function
7	AGND	Analog ground.
8	CS	Output overcurrent adjustment pin. It is connected to the AGND pin through a 5.1 k $\Omega$ internal resistor.
9	MODE	Frequency adjustment pin. It is connected to the ground through a 60.4 k $\Omega$ internal resistor. The default frequency is 1 MHz.
10	VREF	Soft-start setting pin. A soft-start capacitor is embedded in the converter. By default, this pin is left open.
11	RGND	Signal ground.
12	FB	Output adjustment pin. An external resistor divider from the output to RGND sets the output voltage. It is advised to place the resistor divider as close to FB as possible. Vias should be avoided on the FB traces.
13	EN	Enable pin. The converter is enabled when the pin is left open and disabled when the pin is low level. For details, see <a href="#">Remote On/Off (EN)</a> .
14	PG	Power good signal. This is an open-drain signal. The pull-up resistor can be connected to any voltage 0.8–4.0 V. If not used, leave it floating.
15, 19, 20	V <sub>in</sub>	Power input pins. Connect these pins to input power supply and place input filter capacitors between these pins and PGND pins.

# 2 Electrical Specifications

## 2.1 Absolute Maximum Ratings

Parameter	Min.	Typ.	Max.	Unit	Notes & Conditions
Input voltage (continuous)	-	-	15	V	<ul style="list-style-type: none"> <li><math>V_{in} &gt; 14</math> V, tested the voltage stress in district I.</li> <li><math>V_{in} = 18</math> V, <math>t \leq 100</math> ms, the converter must not be damaged. Not all the characteristic parameters should be conform to the specification.</li> </ul>
Operating ambient temperature ( $T_A$ )	-40	-	85	°C	-
Operating junction temperature ( $T_j$ )	-40	-	125	°C	-
Storage temperature	-55	-	125	°C	-
Operating humidity	5	-	95	% RH	Non-condensing
External voltage applied to On/Off	-	-	4	V	-
Weight	-	1.6	-	g	-
Altitude	-	-	3000	m	-

## 2.2 Input Characteristics

Parameter	Min.	Typ.	Max.	Unit	Notes & Conditions
Operating input voltage	8	12	14	V	-
	4.5	5.4	6.0	V	-

Parameter	Min.	Typ.	Max.	Unit	Notes & Conditions
	3.0	3.3	3.6	V	-
Maximum input current	-	-	25	A	$V_{in} = 0-14\text{ V}$ ; $I_{out} = I_{onom}$
No-load loss	-	0.5	0.95	W	$V_{in} = 12\text{ V}$ ; $V_{out} = 0.6\text{ V}$ , $I_{out} = 0\text{ A}$ , Freq = 600 kHz
	-	0.75	1.25	W	$V_{in} = 12\text{ V}$ ; $V_{out} = 0.9\text{ V}$ , $I_{out} = 0\text{ A}$ , Freq = 600 kHz
	-	1	1.5	W	$V_{in} = 12\text{ V}$ ; $V_{out} = 1.2\text{ V}$ , $I_{out} = 0\text{ A}$ , Freq = 600 kHz
	-	2	2.5	W	$V_{in} = 12\text{ V}$ ; $V_{out} = 3.3\text{ V}$ , $I_{out} = 0\text{ A}$ , Freq = 1000 kHz
Input capacitance	30+100	-	-	$\mu\text{F}$	30 $\mu\text{F}$ ceramic capacitor + 100 $\mu\text{F}$ polymer aluminum capacitor

## 2.3 Output Characteristics

Parameter	Min.	Typ.	Max.	Unit	Notes & Conditions
Output voltage setpoint	-1.0	-	1.0	% $V_{oset}$	$V_{in} = 12\text{ V}$ ; $I_{out} = 50\%I_{onom}$ ; Tested with 1% tolerance for external resistor used to set output voltage
Output voltage	0.6	-	3.7	V	$V_{in} = 8-14\text{ V}$ , including 3.7 V
	3.7	-	5.5	V	$V_{in} = 9-14\text{ V}$ , excluding 3.7 V
	0.6	-	2.1	V	$V_{in} = 4.5-6.0\text{ V}$
	0.6	-	1.2	V	$V_{in} = 3.0-3.6\text{ V}$
Output current	0	-	20	A	-
Line regulation	-1	-	1	%	$I_{out} = I_{onom}$
Load regulation	-1	-	1	%	$I_{out} = I_{omin} - I_{onom}$
Regulated voltage precision	-2	-	2	%	$I_{out} = I_{omin} - I_{onom}$

Parameter	Min.	Typ.	Max.	Unit	Notes & Conditions
Temperature coefficient	-0.02	-	0.02	%/°C	$T_A = -40^{\circ}\text{C}$ to $+85^{\circ}\text{C}$
External capacitance	47 x 5	-	6000	$\mu\text{F}$	$V_{\text{out}} \leq 3.7\text{ V}$ ; 47 $\mu\text{F}$ ceramic capacitor; 6000 $\mu\text{F}$ ceramic capacitor; 6000 $\mu\text{F}$ polymer aluminum capacitor; 3000 $\mu\text{F}$ polymer aluminum capacitor + 3000 $\mu\text{F}$ ceramic capacitor
	22 x 15	-	6000	$\mu\text{F}$	$V_{\text{out}} > 3.7\text{ V}$ ; 22 $\mu\text{F}$ ceramic capacitor; 6000 $\mu\text{F}$ ceramic capacitor; 6000 $\mu\text{F}$ polymer aluminum capacitor; 3000 $\mu\text{F}$ polymer aluminum capacitor + 3000 $\mu\text{F}$ ceramic capacitor
Output ripple and noise (peak to peak)	-	10	20	mV	$V_{\text{out}} \leq 1.8\text{ V}$ ; Oscilloscope bandwidth: 20 MHz
	-	30	50	mV	$V_{\text{out}} > 1.8\text{ V}$ ; Oscilloscope bandwidth: 20 MHz
Output voltage overshoot	-	-	5	%	Full range of $V_{\text{in}}$ , $I_{\text{out}}$ , and $T_A$
Output voltage delay time	-	1.5	5	ms	-
Output voltage rise time	-	2.3	5	ms	-
Switching frequency	-	600	-	kHz	$V_{\text{in}} = 8\text{-}14\text{ V}$ , $V_{\text{out}} \leq 1.8\text{ V}$ , $I_{\text{out}} = 50\%I_{\text{onom}}$
	-	1000	-	kHz	$V_{\text{in}} = 8\text{-}14\text{ V}$ , $V_{\text{out}} > 1.8\text{ V}$ , $I_{\text{out}} = 50\%I_{\text{onom}}$
	-	600	-	kHz	$V_{\text{in}} = 4.5\text{-}6.0\text{ V}$ , $V_{\text{out}} \leq 1.8\text{ V}$ , $I_{\text{out}} = 50\%I_{\text{onom}}$
	-	1000	-	kHz	$V_{\text{in}} = 4.5\text{-}6.0\text{ V}$ , $V_{\text{out}} > 1.8\text{ V}$ , $I_{\text{out}} = 50\%I_{\text{onom}}$

Parameter	Min.	Typ.	Max.	Unit	Notes & Conditions
	-	600	-	kHz	$V_{in} = 3.0\text{-}3.6\text{ V}$ , $I_{out} = 50\%I_{onom}$

#### NOTE

This is a class A product. In residential areas, this product may cause radio interference. Therefore, users may be required to take appropriate measures.

## 2.4 Protection

**Table 2-1** Input Protection

Parameter	Min.	Typ.	Max.	Unit	Notes & Conditions
Input undervoltage protection threshold	5	6	7	V	$V_{in} = 8\text{-}14\text{ V}$ , $V_{out} \leq 3.7\text{ V}$
Input undervoltage protection recovery threshold	6	7	8	V	
Input undervoltage protection hysteresis	0.5	1.0	2	V	
Input undervoltage protection threshold	6	7	8	V	$V_{in} = 9\text{-}14\text{ V}$ , $V_{out} > 3.7\text{ V}$
Input undervoltage protection recovery threshold	7	8	9	V	
Input undervoltage protection hysteresis	0.5	1.0	2	V	
Input undervoltage protection threshold	3.3	3.55	3.8	V	$V_{in} = 4.5\text{-}6.0\text{ V}$
Input undervoltage protection recovery threshold	4	4.25	4.5	V	
Input undervoltage protection hysteresis	0.4	0.7	1.0	V	
Input undervoltage protection threshold	2.2	2.4	2.7	V	$V_{in} = 3.0\text{-}3.6\text{ V}$

Parameter	Min.	Typ.	Max.	Unit	Notes & Conditions
Input undervoltage protection recovery threshold	2.65	2.85	3.0	V	
Input undervoltage protection hysteresis	0.2	0.4	0.6	V	

**Table 2-2** Output Protection

Parameter	Min.	Typ.	Max.	Unit	Notes & Conditions
Output overcurrent protection	110	-	200	%	Hiccup mode
Output short circuit protection	-	-	-	-	Hiccup mode
Output overvoltage protection	105	-	150	%V <sub>oset</sub>	Self-recovery
Overtemperature protection threshold	140	160	170	°C	Self-recovery The temperature of the overtemperature protection is T <sub>j</sub> , module internal temperature can be calculated through thermal resistance of mode. The overtemperature protection threshold is obtained by measuring the surface temperature of converter.
Overtemperature protection hysteresis	-	30	-	°C	

## 2.5 Dynamic Characteristics

Parameter	Min.	Typ.	Max.	Unit	Notes & Conditions
Overshoot amplitude	-	-	5	%V <sub>out</sub>	Current change rate: 5 A/μs Load: 25%–50%–25%; 50%–75%–50%
Recovery time	-	-	200	μs	

## 2.6 Efficiency

Parameter	Min.	Typ.	Max.	Units	Notes & Conditions
50% load	77.5	78.5	-	%	$V_{in} = 12\text{ V}; V_{out} = 0.6\text{ V}; T_A = 25^\circ\text{C}$ (77°F)
	78.5	79.5	-	%	$V_{in} = 12\text{ V}; V_{out} = 0.7\text{ V}; T_A = 25^\circ\text{C}$ (77°F)
	79.5	80.5	-	%	$V_{in} = 12\text{ V}; V_{out} = 0.8\text{ V}; T_A = 25^\circ\text{C}$ (77°F)
	80.5	81.5	-	%	$V_{in} = 12\text{ V}; V_{out} = 0.9\text{ V}; T_A = 25^\circ\text{C}$ (77°F)
	81	82	-	%	$V_{in} = 12\text{ V}; V_{out} = 1.0\text{ V}; T_A = 25^\circ\text{C}$ (77°F)
	82.5	83.5	-	%	$V_{in} = 12\text{ V}; V_{out} = 1.2\text{ V}; T_A = 25^\circ\text{C}$ (77°F)
	85.5	86.5	-	%	$V_{in} = 12\text{ V}; V_{out} = 1.5\text{ V}; T_A = 25^\circ\text{C}$ (77°F)
	86	87	-	%	$V_{in} = 12\text{ V}; V_{out} = 1.8\text{ V}; T_A = 25^\circ\text{C}$ (77°F)
	86	87	-	%	$V_{in} = 12\text{ V}; V_{out} = 2.5\text{ V}; T_A = 25^\circ\text{C}$ (77°F)
	87.5	88.5	-	%	$V_{in} = 12\text{ V}; V_{out} = 3.3\text{ V}; T_A = 25^\circ\text{C}$ (77°F)
	89	90	-	%	$V_{in} = 12\text{ V}; V_{out} = 3.7\text{ V}; T_A = 25^\circ\text{C}$ (77°F)
	90	91	-	%	$V_{in} = 12\text{ V}; V_{out} = 5.0\text{ V}; T_A = 25^\circ\text{C}$ (77°F)
	90.5	91.5	-	%	$V_{in} = 12\text{ V}; V_{out} = 5.5\text{ V}; T_A = 25^\circ\text{C}$ (77°F)
	84.5	85.5	-	%	$V_{in} = 5.4\text{ V}; V_{out} = 0.6\text{ V}; T_A = 25^\circ\text{C}$ (77°F)
	85.5	86.5	-	%	$V_{in} = 5.4\text{ V}; V_{out} = 0.7\text{ V}; T_A = 25^\circ\text{C}$ (77°F)
	86.5	87	-	%	$V_{in} = 5.4\text{ V}; V_{out} = 0.8\text{ V}; T_A = 25^\circ\text{C}$ (77°F)

Parameter	Min.	Typ.	Max.	Units	Notes & Conditions
	87.5	88	-	%	$V_{in} = 5.4 \text{ V}; V_{out} = 0.9 \text{ V}; T_A = 25^\circ\text{C}$ (77°F)
	88.5	89	-	%	$V_{in} = 5.4 \text{ V}; V_{out} = 1.0 \text{ V}; T_A = 25^\circ\text{C}$ (77°F)
	89	89.5	-	%	$V_{in} = 5.4 \text{ V}; V_{out} = 1.2 \text{ V}; T_A = 25^\circ\text{C}$ (77°F)
	90	90.5	-	%	$V_{in} = 5.4 \text{ V}; V_{out} = 1.5 \text{ V}; T_A = 25^\circ\text{C}$ (77°F)
	91.5	92	-	%	$V_{in} = 5.4 \text{ V}; V_{out} = 1.8 \text{ V}; T_A = 25^\circ\text{C}$ (77°F)
	90.5	91	-	%	$V_{in} = 5.4 \text{ V}; V_{out} = 2.1 \text{ V}; T_A = 25^\circ\text{C}$ (77°F)
	85	86.5	-	%	$V_{in} = 3.3 \text{ V}; V_{out} = 0.6 \text{ V}; T_A = 25^\circ\text{C}$ (77°F)
	86	87	-	%	$V_{in} = 3.3 \text{ V}; V_{out} = 0.7 \text{ V}; T_A = 25^\circ\text{C}$ (77°F)
	86.5	87.5	-	%	$V_{in} = 3.3 \text{ V}; V_{out} = 0.8 \text{ V}; T_A = 25^\circ\text{C}$ (77°F)
	87	88	-	%	$V_{in} = 3.3 \text{ V}; V_{out} = 0.9 \text{ V}; T_A = 25^\circ\text{C}$ (77°F)
	87.5	88.5	-	%	$V_{in} = 3.3 \text{ V}; V_{out} = 1.0 \text{ V}; T_A = 25^\circ\text{C}$ (77°F)
	88	89	-	%	$V_{in} = 3.3 \text{ V}; V_{out} = 1.2 \text{ V}; T_A = 25^\circ\text{C}$ (77°F)
100% load	71.5	73	-	%	$V_{in} = 12 \text{ V}; V_{out} = 0.6 \text{ V}; T_A = 25^\circ\text{C}$ (77°F)
	73	74	-	%	$V_{in} = 12 \text{ V}; V_{out} = 0.7 \text{ V}; T_A = 25^\circ\text{C}$ (77°F)
	74.5	75.5	-	%	$V_{in} = 12 \text{ V}; V_{out} = 0.8 \text{ V}; T_A = 25^\circ\text{C}$ (77°F)
	75.5	76.5	-	%	$V_{in} = 12 \text{ V}; V_{out} = 0.9 \text{ V}; T_A = 25^\circ\text{C}$ (77°F)
	78	79	-	%	$V_{in} = 12 \text{ V}; V_{out} = 1.0 \text{ V}; T_A = 25^\circ\text{C}$ (77°F)



Parameter	Min.	Typ.	Max.	Units	Notes & Conditions
	80.5	81.5	-	%	$V_{in} = 12\text{ V}; V_{out} = 1.2\text{ V}; T_A = 25^\circ\text{C}$ (77°F)
	83	83.5	-	%	$V_{in} = 12\text{ V}; V_{out} = 1.5\text{ V}; T_A = 25^\circ\text{C}$ (77°F)
	84	84.5	-	%	$V_{in} = 12\text{ V}; V_{out} = 1.8\text{ V}; T_A = 25^\circ\text{C}$ (77°F)
	85	85.5	-	%	$V_{in} = 12\text{ V}; V_{out} = 2.5\text{ V}; T_A = 25^\circ\text{C}$ (77°F)
	86.5	87	-	%	$V_{in} = 12\text{ V}; V_{out} = 3.3\text{ V}; T_A = 25^\circ\text{C}$ (77°F)
	87.5	88	-	%	$V_{in} = 12\text{ V}; V_{out} = 3.7\text{ V}; T_A = 25^\circ\text{C}$ (77°F)
	88.5	89	-	%	$V_{in} = 12\text{ V}; V_{out} = 5.0\text{ V}; T_A = 25^\circ\text{C}$ (77°F)
	89	91.5	-	%	$V_{in} = 12\text{ V}; V_{out} = 5.5\text{ V}; T_A = 25^\circ\text{C}$ (77°F)
	76	78.5	-	%	$V_{in} = 5.4\text{ V}; V_{out} = 0.6\text{ V}; T_A = 25^\circ\text{C}$ (77°F)
	77.5	78.5	-	%	$V_{in} = 5.4\text{ V}; V_{out} = 0.7\text{ V}; T_A = 25^\circ\text{C}$ (77°F)
	79.5	80.5	-	%	$V_{in} = 5.4\text{ V}; V_{out} = 0.8\text{ V}; T_A = 25^\circ\text{C}$ (77°F)
	80	81	-	%	$V_{in} = 5.4\text{ V}; V_{out} = 0.9\text{ V}; T_A = 25^\circ\text{C}$ (77°F)
	82	83	-	%	$V_{in} = 5.4\text{ V}; V_{out} = 1.0\text{ V}; T_A = 25^\circ\text{C}$ (77°F)
	83.5	84.5	-	%	$V_{in} = 5.4\text{ V}; V_{out} = 1.2\text{ V}; T_A = 25^\circ\text{C}$ (77°F)
	84.5	85.5	-	%	$V_{in} = 5.4\text{ V}; V_{out} = 1.5\text{ V}; T_A = 25^\circ\text{C}$ (77°F)
	86.5	87.5	-	%	$V_{in} = 5.4\text{ V}; V_{out} = 1.8\text{ V}; T_A = 25^\circ\text{C}$ (77°F)
	88.5	89	-	%	$V_{in} = 5.4\text{ V}; V_{out} = 2.1\text{ V}; T_A = 25^\circ\text{C}$ (77°F)

Parameter	Min.	Typ.	Max.	Units	Notes & Conditions
	74.5	76	-	%	$V_{in} = 3.3\text{ V}; V_{out} = 0.6\text{ V}; T_A = 25^\circ\text{C}$ (77°F)
	75.5	76.5	-	%	$V_{in} = 3.3\text{ V}; V_{out} = 0.7\text{ V}; T_A = 25^\circ\text{C}$ (77°F)
	77.5	78.5	-	%	$V_{in} = 3.3\text{ V}; V_{out} = 0.8\text{ V}; T_A = 25^\circ\text{C}$ (77°F)
	79	80	-	%	$V_{in} = 3.3\text{ V}; V_{out} = 0.9\text{ V}; T_A = 25^\circ\text{C}$ (77°F)
	80	81	-	%	$V_{in} = 3.3\text{ V}; V_{out} = 1.0\text{ V}; T_A = 25^\circ\text{C}$ (77°F)
	81	82	-	%	$V_{in} = 3.3\text{ V}; V_{out} = 1.2\text{ V}; T_A = 25^\circ\text{C}$ (77°F)

## 2.7 Other Characteristics

Parameter	Min.	Typ.	Max.	Unit	Notes & Conditions
Remote On/Off voltage low level	-0.2	-	0.5	V	Positive logic
Remote On/Off voltage high level	1.3	-	4.0	V	
SENSE+	-	-	100	mV	
SENSE-	-	-	-	mV	
Mean time between failures (MTBF)	-	2.5	-	Million hours	Telcordia, SR332 Method 1 Case 3; 80% load; normal input; rated output; airflow rate = 1.5 m/s (300 LFM); $T_A = 40^\circ\text{C}$

# 3 Characteristic Curves

## 3.1 Efficiency and Power Dissipation Curves

Conditions:  $T_A = 25^\circ\text{C}$ , unless otherwise specified

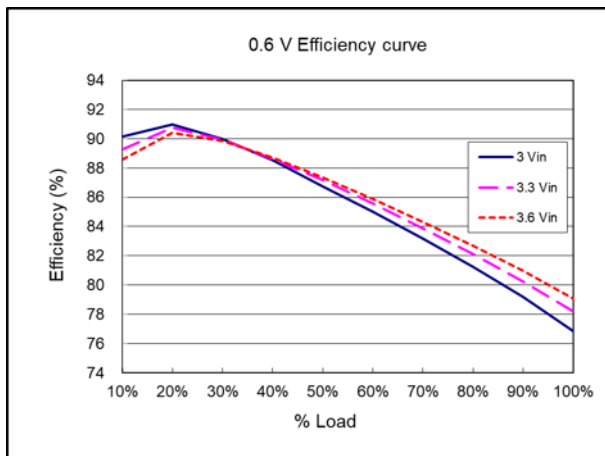

Efficiency curve ( $V_{nom} = 3.3\text{ V}$ ,  $V_{out} = 0.6\text{ V}$ )

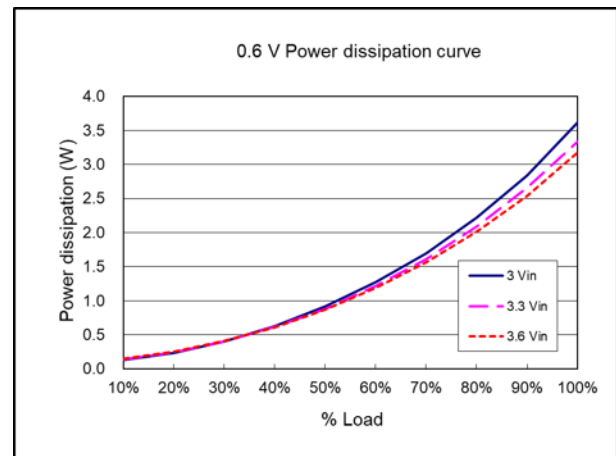

Power dissipation curve ( $V_{nom} = 3.3\text{ V}$ ,  $V_{out} = 0.6\text{ V}$ )

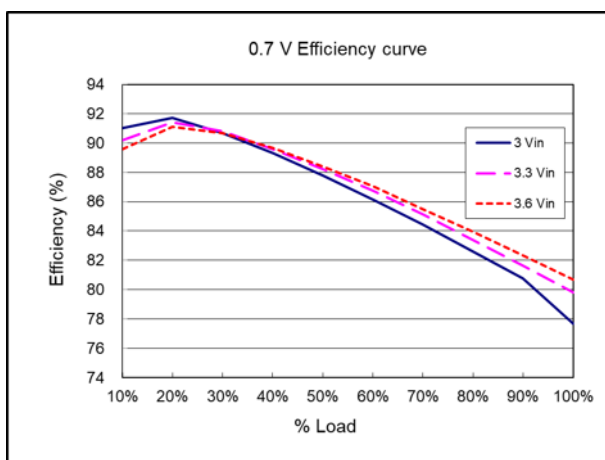

Efficiency curve ( $V_{nom} = 3.3\text{ V}$ ,  $V_{out} = 0.7\text{ V}$ )

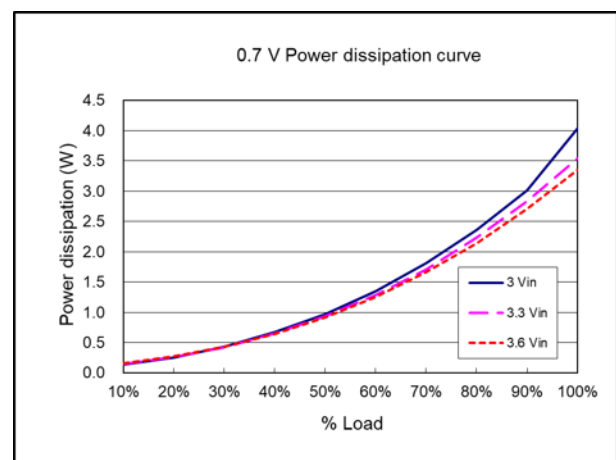

Power dissipation curve ( $V_{nom} = 3.3\text{ V}$ ,  $V_{out} = 0.7\text{ V}$ )

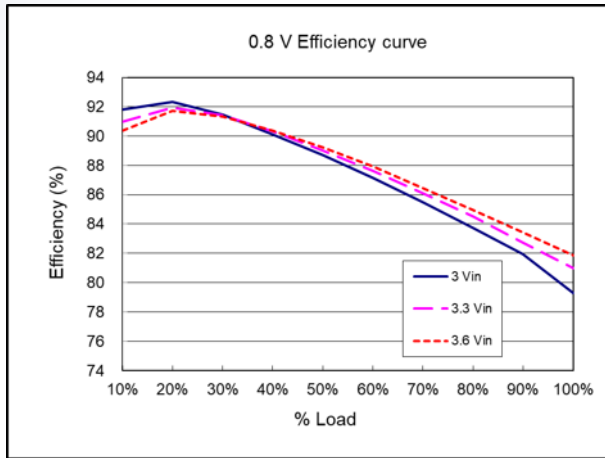

Efficiency curve ( $V_{nom} = 3.3 V$ ,  $V_{out} = 0.8 V$ )

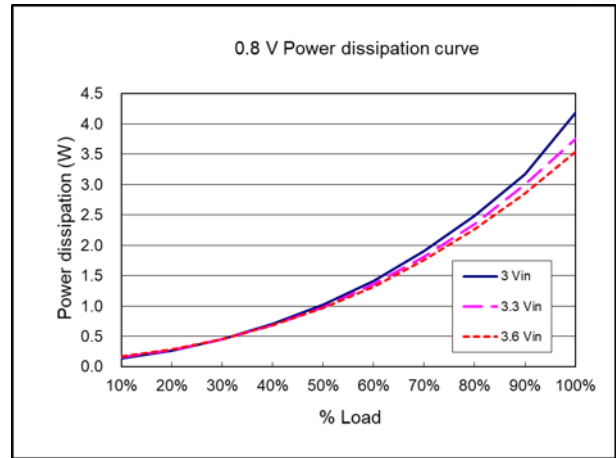

Power dissipation curve ( $V_{nom} = 3.3 V$ ,  $V_{out} = 0.8 V$ )

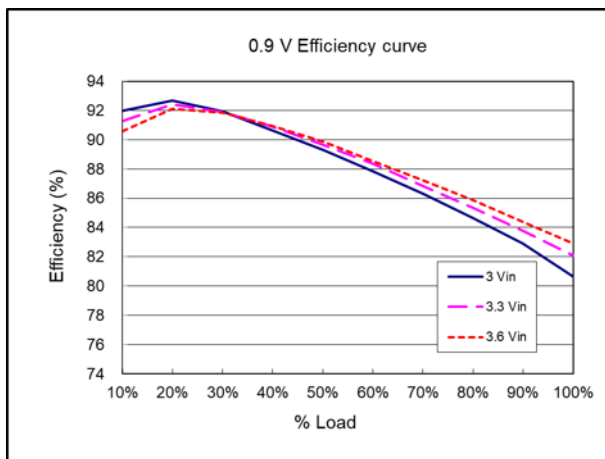

Efficiency curve ( $V_{nom} = 3.3 V$ ,  $V_{out} = 0.9 V$ )

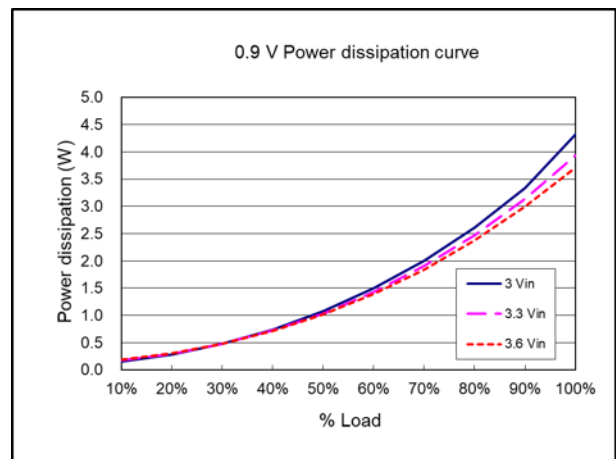

Power dissipation curve ( $V_{nom} = 3.3 V$ ,  $V_{out} = 0.9 V$ )

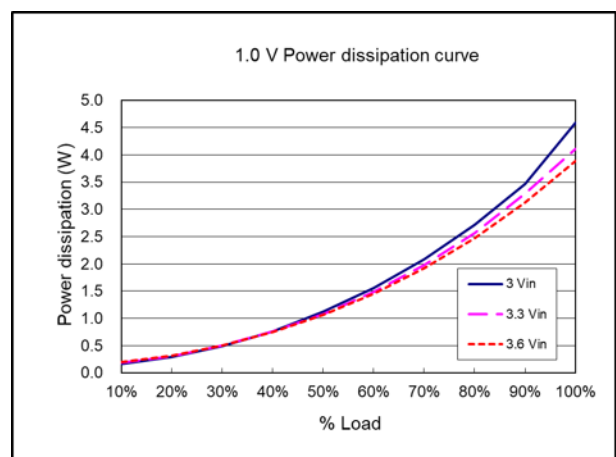
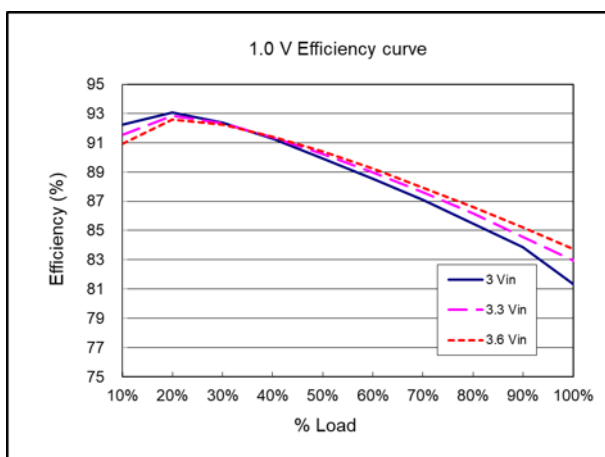

Efficiency curve ( $V_{nom} = 3.3\text{ V}$ ,  $V_{out} = 1.0\text{ V}$ )

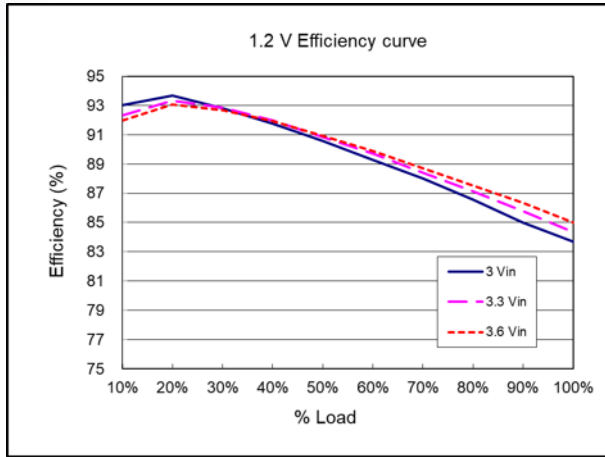

Power dissipation curve ( $V_{nom} = 3.3\text{ V}$ ,  $V_{out} = 1.0\text{ V}$ )

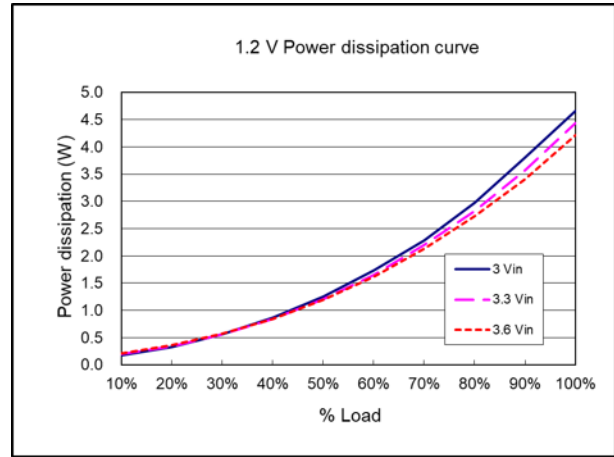

Efficiency curve ( $V_{nom} = 3.3\text{ V}$ ,  $V_{out} = 1.2\text{ V}$ )

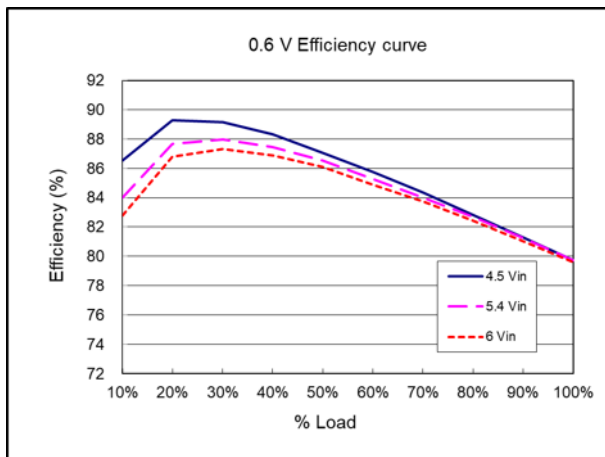

Power dissipation curve ( $V_{nom} = 3.3\text{ V}$ ,  $V_{out} = 1.2\text{ V}$ )

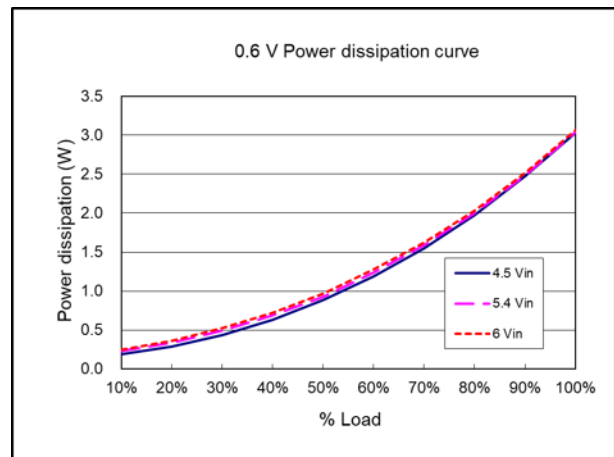

Efficiency curve ( $V_{nom} = 5.4\text{ V}$ ,  $V_{out} = 0.6\text{ V}$ )



Power dissipation curve ( $V_{nom} = 5.4\text{ V}$ ,  $V_{out} = 0.6\text{ V}$ )

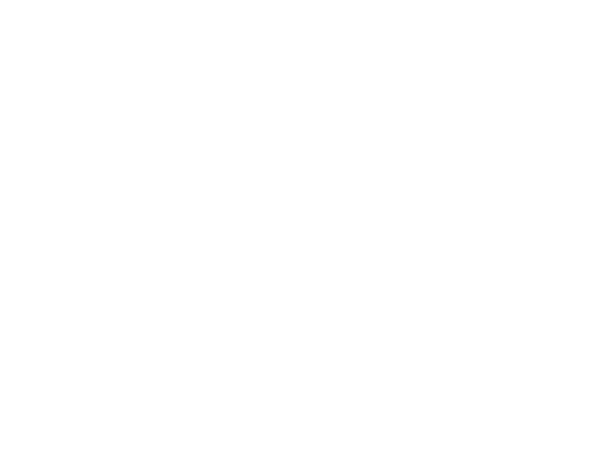

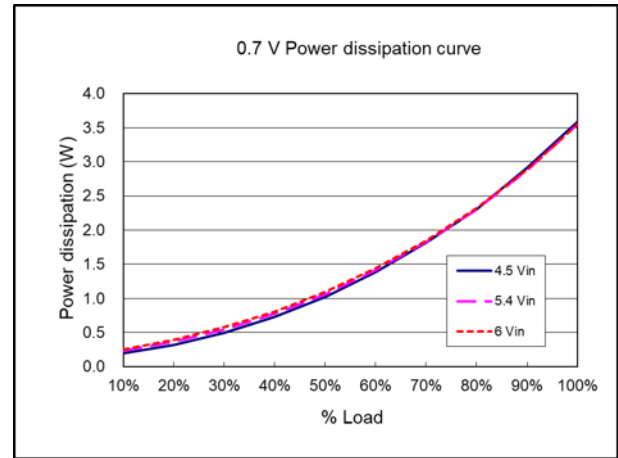
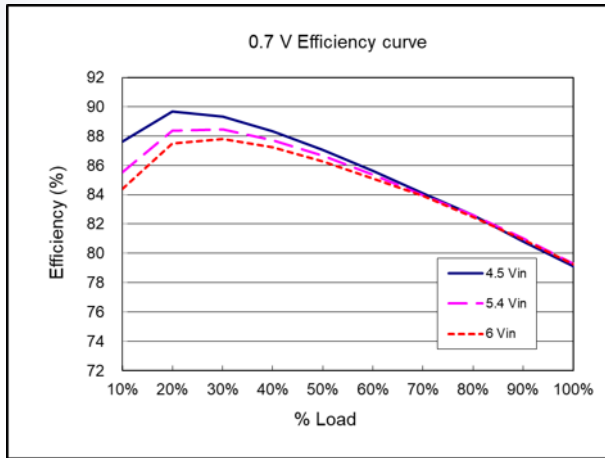

Efficiency curve ( $V_{nom} = 5.4\text{ V}$ ,  $V_{out} = 0.7\text{ V}$ )

Power dissipation curve ( $V_{nom} = 5.4\text{ V}$ ,  $V_{out} = 0.7\text{ V}$ )

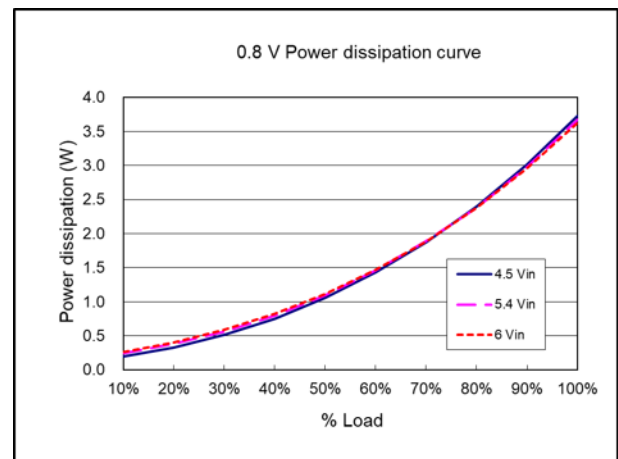
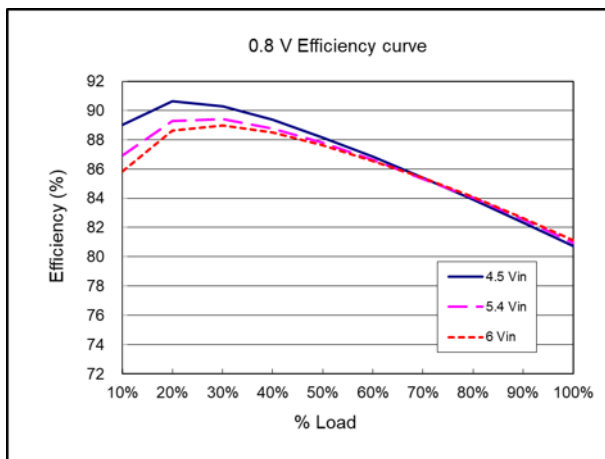

Efficiency curve ( $V_{nom} = 5.4\text{ V}$ ,  $V_{out} = 0.8\text{ V}$ )

Power dissipation curve ( $V_{nom} = 5.4\text{ V}$ ,  $V_{out} = 0.8\text{ V}$ )

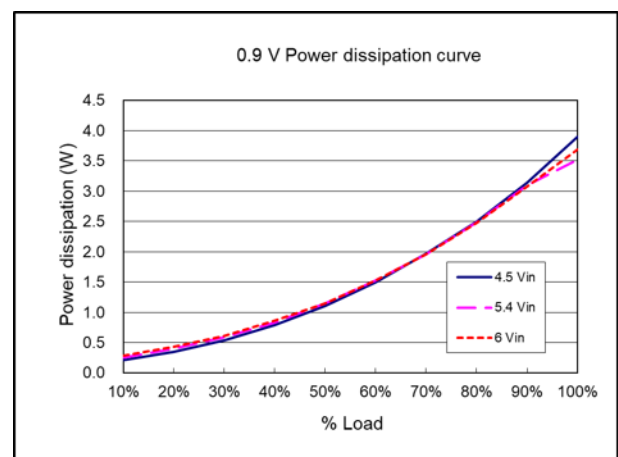
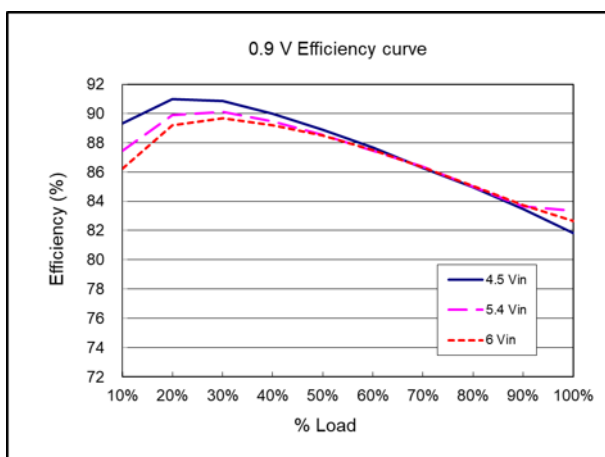

Efficiency curve ( $V_{nom} = 5.4\text{ V}$ ,  $V_{out} = 0.9\text{ V}$ )

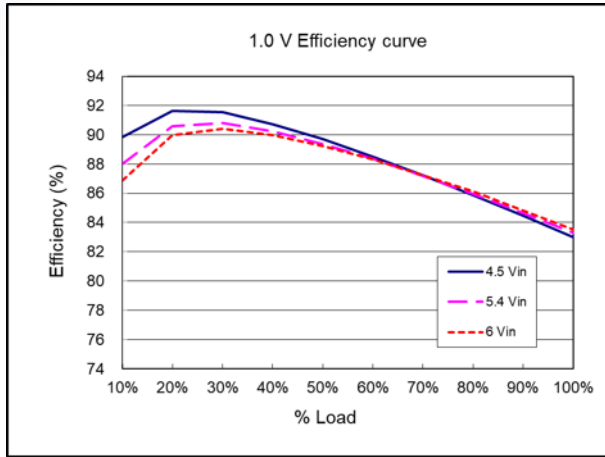

Power dissipation curve ( $V_{nom} = 5.4\text{ V}$ ,  $V_{out} = 0.9\text{ V}$ )

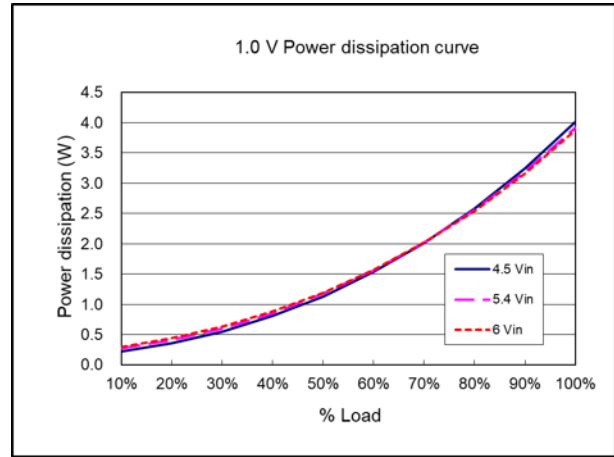

Efficiency curve ( $V_{nom} = 5.4\text{ V}$ ,  $V_{out} = 1.0\text{ V}$ )

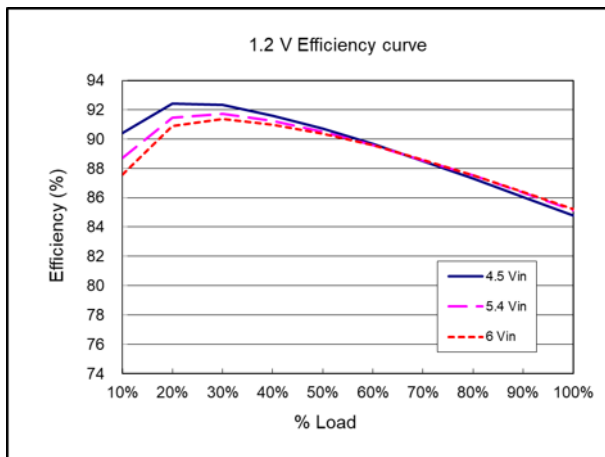

Power dissipation curve ( $V_{nom} = 5.4\text{ V}$ ,  $V_{out} = 1.0\text{ V}$ )

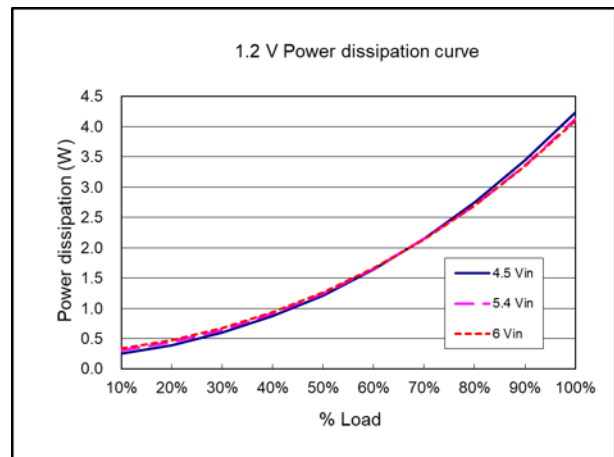

Efficiency curve ( $V_{nom} = 5.4\text{ V}$ ,  $V_{out} = 1.2\text{ V}$ )



Power dissipation curve ( $V_{nom} = 5.4\text{ V}$ ,  $V_{out} = 1.2\text{ V}$ )



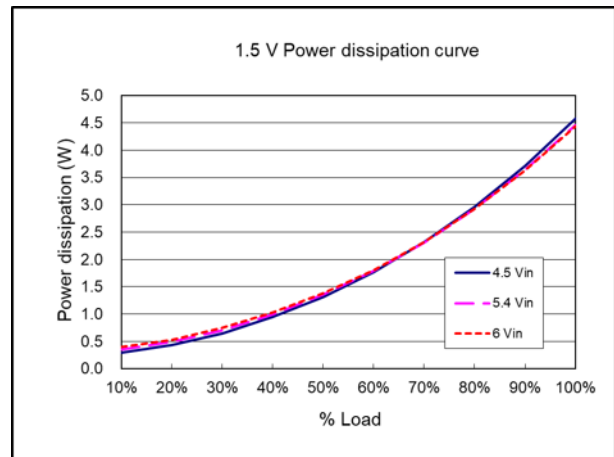
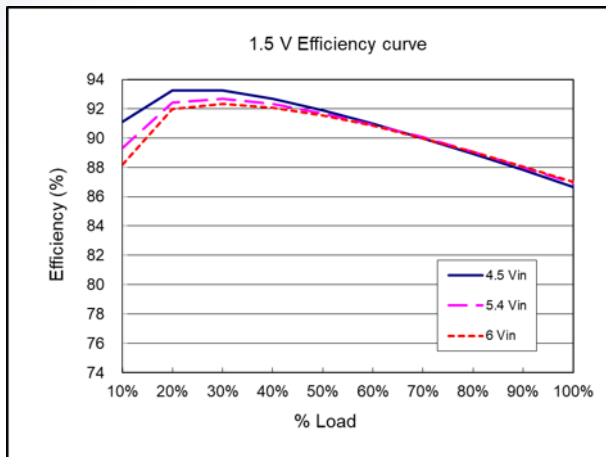

Efficiency curve ( $V_{nom} = 5.4\text{ V}$ ,  $V_{out} = 1.5\text{ V}$ )

Power dissipation curve ( $V_{nom} = 5.4\text{ V}$ ,  $V_{out} = 1.5\text{ V}$ )

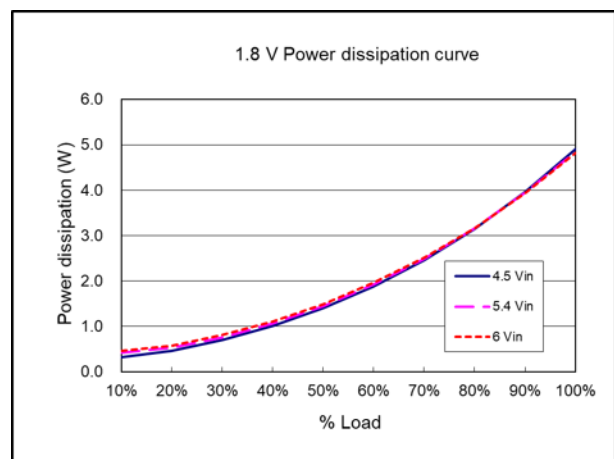
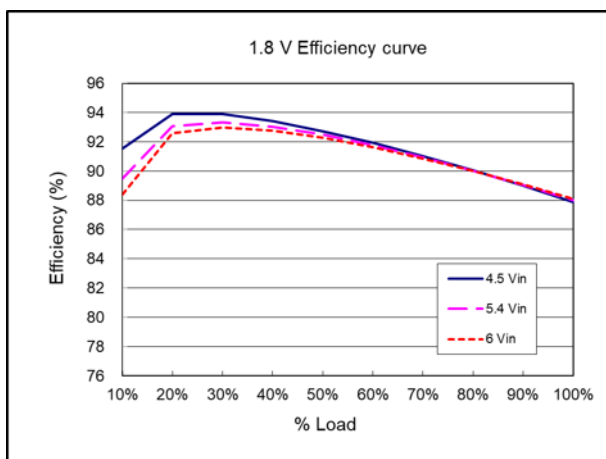

Efficiency curve ( $V_{nom} = 5.4\text{ V}$ ,  $V_{out} = 1.8\text{ V}$ )

Power dissipation curve ( $V_{nom} = 5.4\text{ V}$ ,  $V_{out} = 1.8\text{ V}$ )

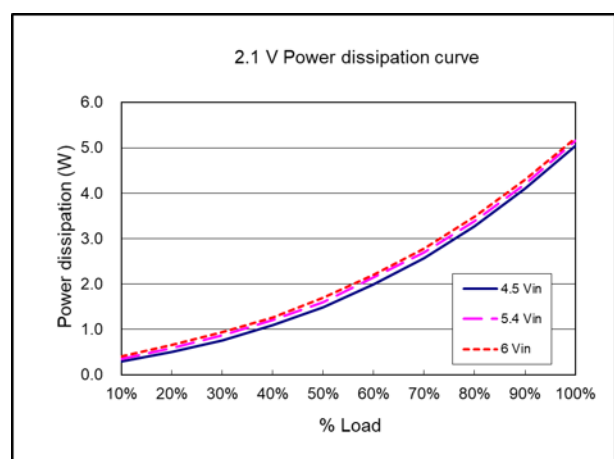
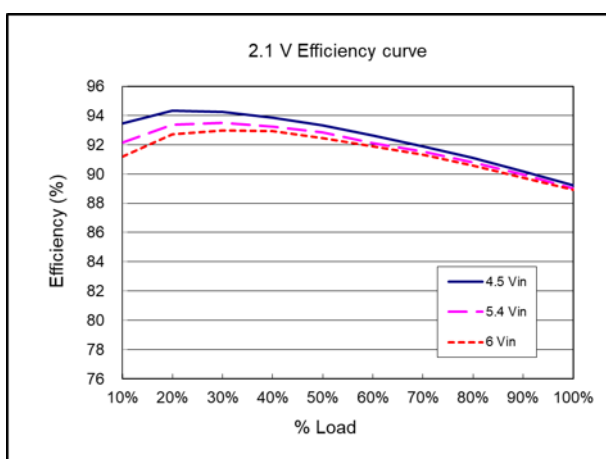



Efficiency curve ( $V_{nom} = 5.4\text{ V}$ ,  $V_{out} = 2.1\text{ V}$ )

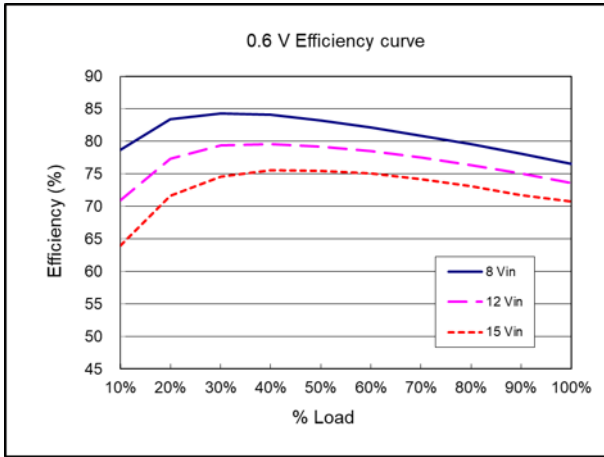

Power dissipation curve ( $V_{nom} = 5.4\text{ V}$ ,  $V_{out} = 2.1\text{ V}$ )

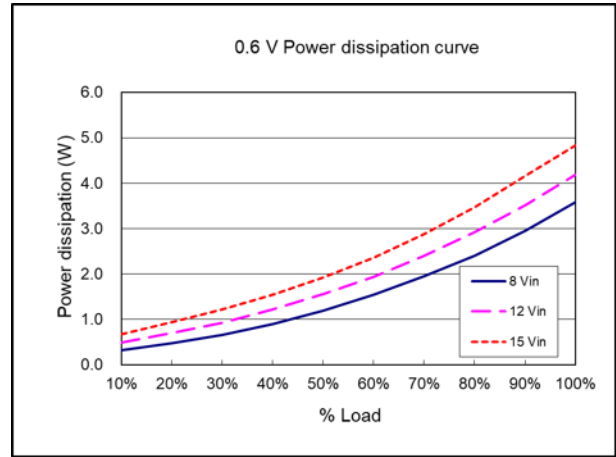

Efficiency curve ( $V_{nom} = 12.0\text{ V}$ ,  $V_{out} = 0.6\text{ V}$ )

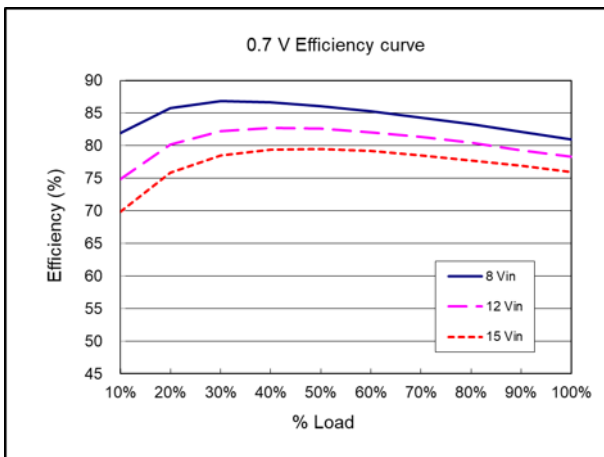

Power dissipation curve ( $V_{nom} = 12.0\text{ V}$ ,  $V_{out} = 0.6\text{ V}$ )

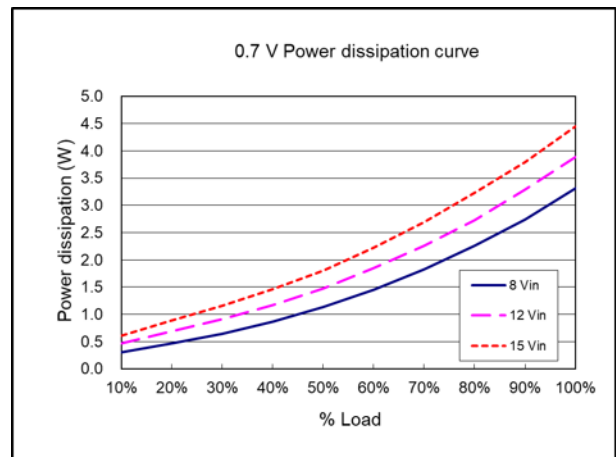

Efficiency curve ( $V_{nom} = 12.0\text{ V}$ ,  $V_{out} = 0.7\text{ V}$ )



Power dissipation curve ( $V_{nom} = 12.0\text{ V}$ ,  $V_{out} = 0.7\text{ V}$ )



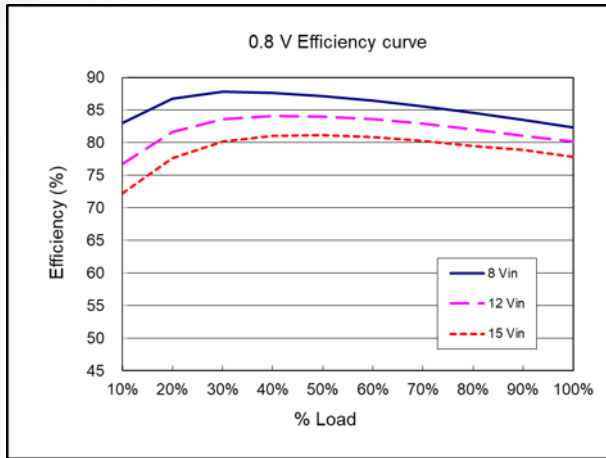

Efficiency curve ( $V_{nom} = 12.0\text{ V}$ ,  $V_{out} = 0.8\text{ V}$ )

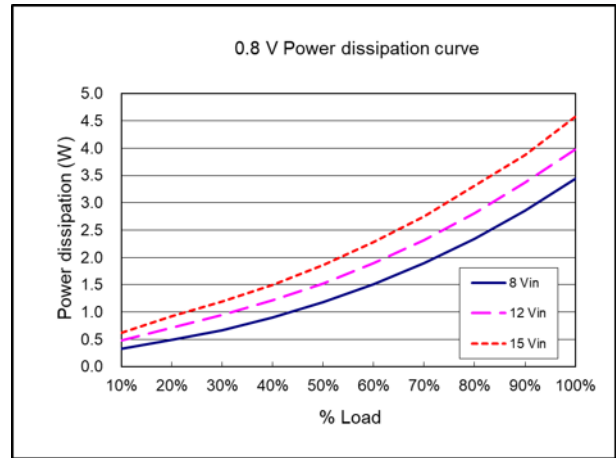

Power dissipation curve ( $V_{nom} = 12.0\text{ V}$ ,  $V_{out} = 0.8\text{ V}$ )

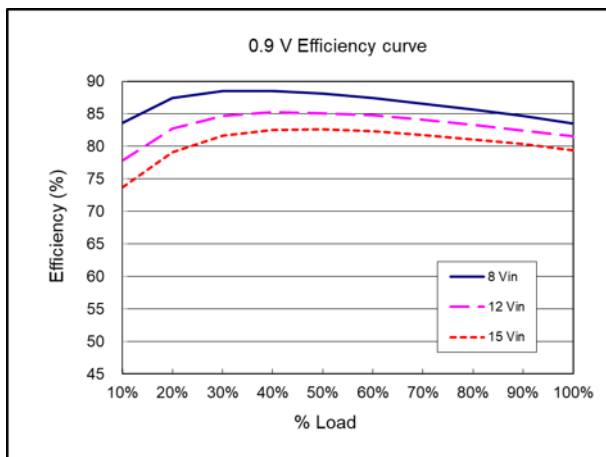

Efficiency curve ( $V_{nom} = 12.0\text{ V}$ ,  $V_{out} = 0.9\text{ V}$ )

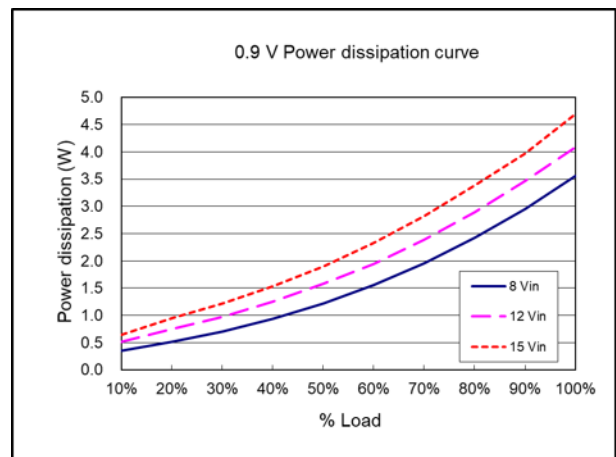

Power dissipation curve ( $V_{nom} = 12.0\text{ V}$ ,  $V_{out} = 0.9\text{ V}$ )

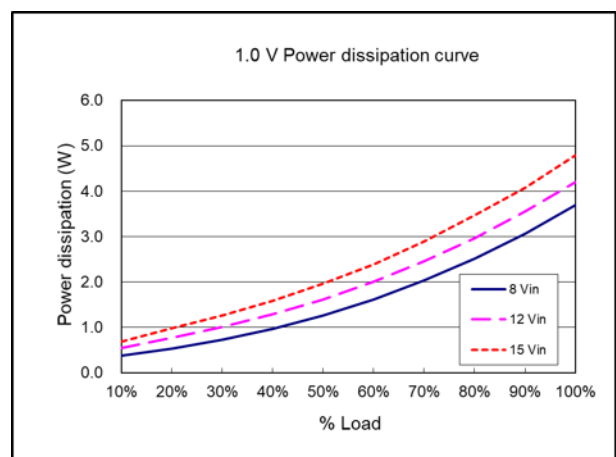
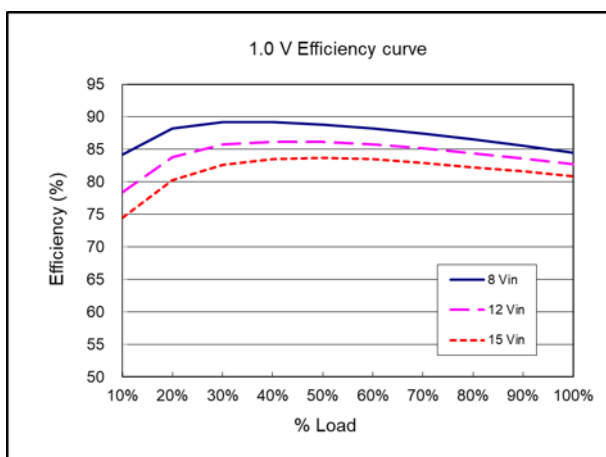

Efficiency curve ( $V_{nom} = 12.0\text{ V}$ ,  $V_{out} = 1.0\text{ V}$ )

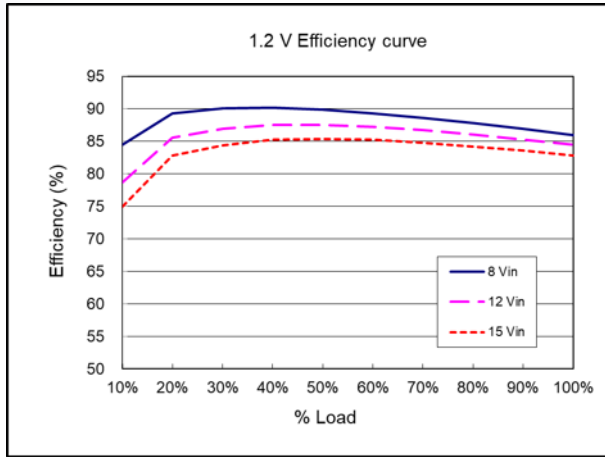

Power dissipation curve ( $V_{nom} = 12.0\text{ V}$ ,  $V_{out} = 1.0\text{ V}$ )

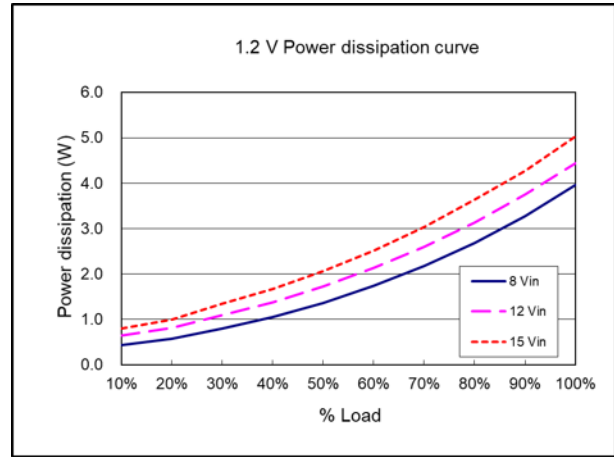

Efficiency curve ( $V_{nom} = 12.0\text{ V}$ ,  $V_{out} = 1.2\text{ V}$ )

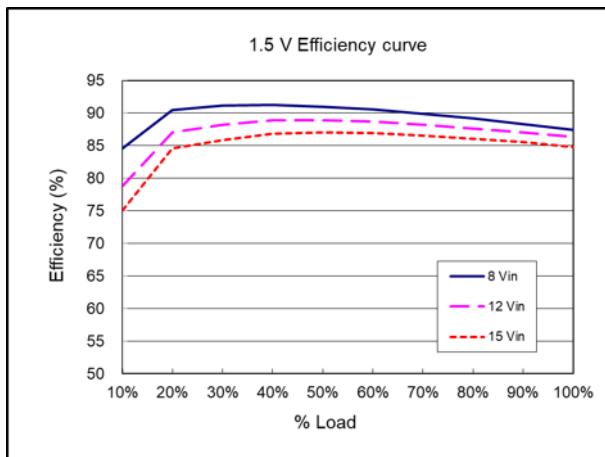

Power dissipation curve ( $V_{nom} = 12.0\text{ V}$ ,  $V_{out} = 1.2\text{ V}$ )

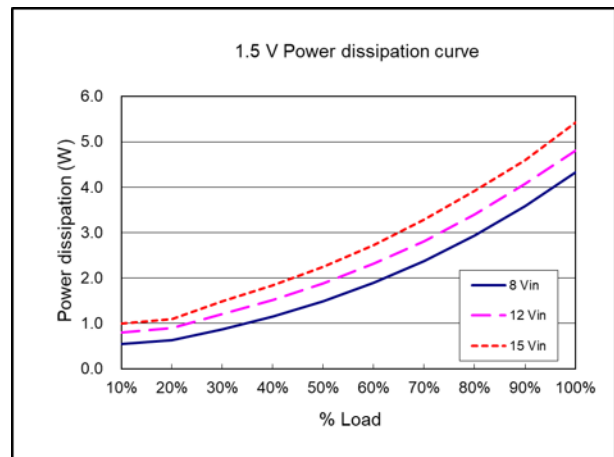

Efficiency curve ( $V_{nom} = 12.0\text{ V}$ ,  $V_{out} = 1.5\text{ V}$ )



Power dissipation curve ( $V_{nom} = 12.0\text{ V}$ ,  $V_{out} = 1.5\text{ V}$ )



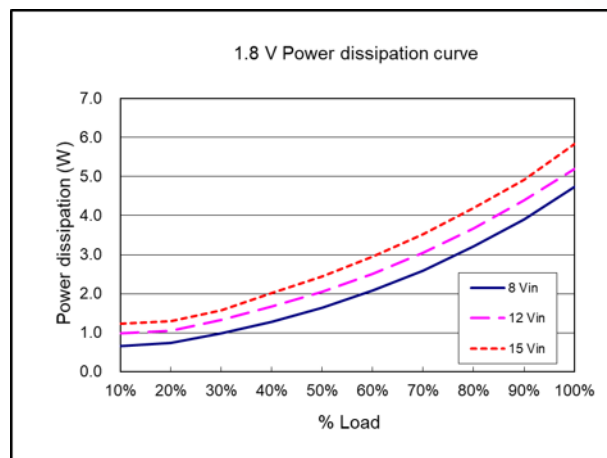
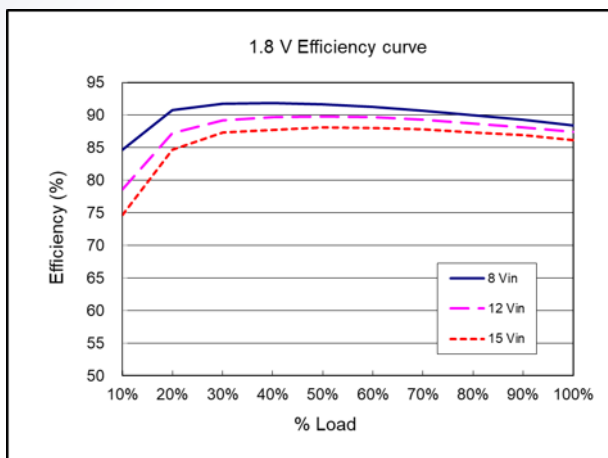

Efficiency curve ( $V_{nom} = 12.0\text{ V}$ ,  $V_{out} = 1.8\text{ V}$ )

Power dissipation curve ( $V_{nom} = 12.0\text{ V}$ ,  $V_{out} = 1.8\text{ V}$ )

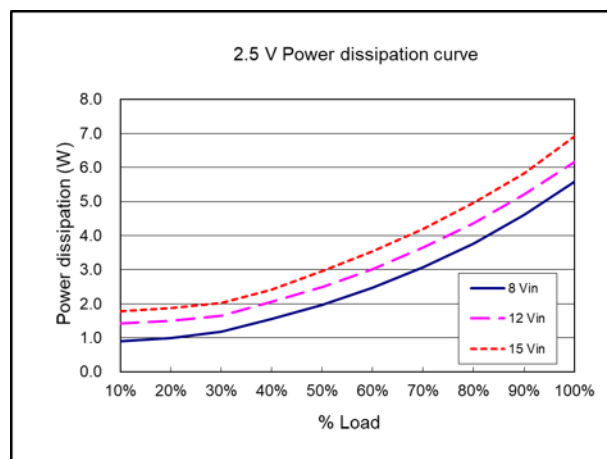
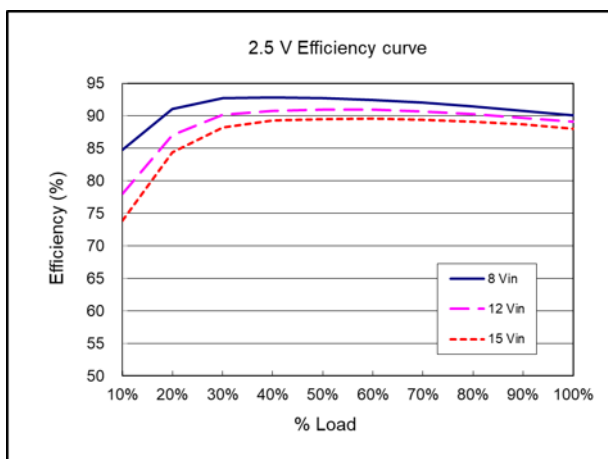

Efficiency curve ( $V_{nom} = 12.0\text{ V}$ ,  $V_{out} = 2.5\text{ V}$ )

Power dissipation curve ( $V_{nom} = 12.0\text{ V}$ ,  $V_{out} = 2.5\text{ V}$ )

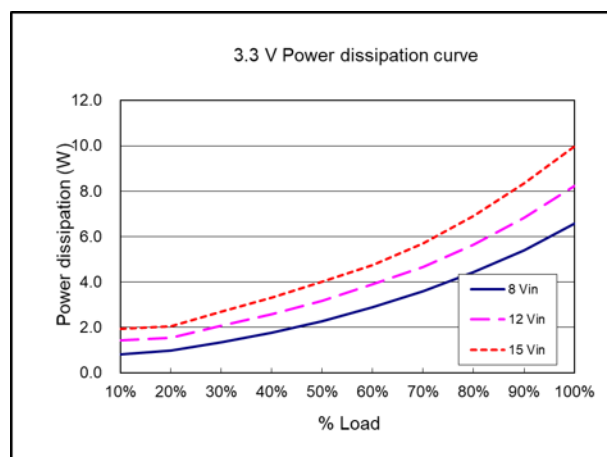
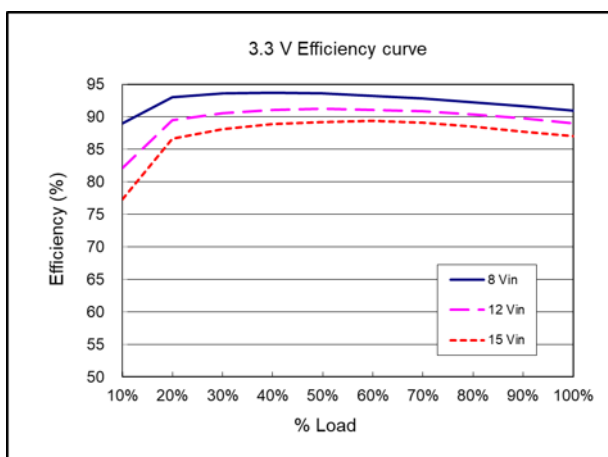

Efficiency curve ( $V_{nom} = 12.0\text{ V}$ ,  $V_{out} = 3.3\text{ V}$ )

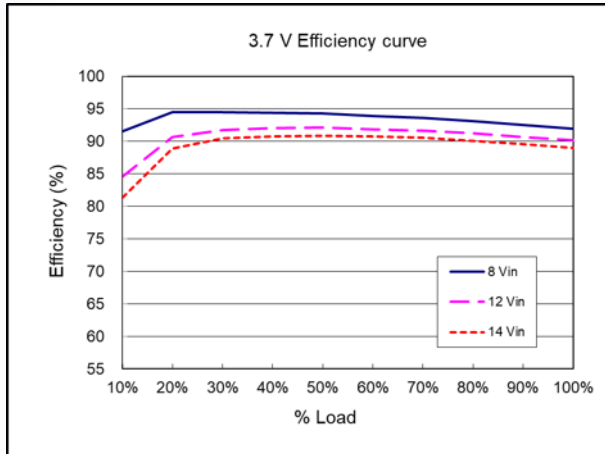

Power dissipation curve ( $V_{nom} = 12.0\text{ V}$ ,  $V_{out} = 3.3\text{ V}$ )

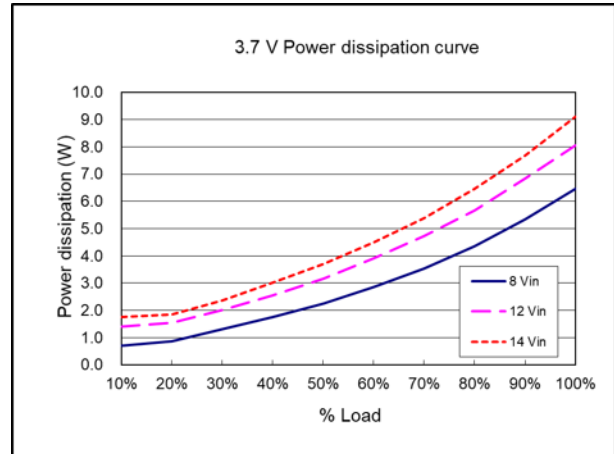

Efficiency curve ( $V_{nom} = 12.0\text{ V}$ ,  $V_{out} = 3.7\text{ V}$ )

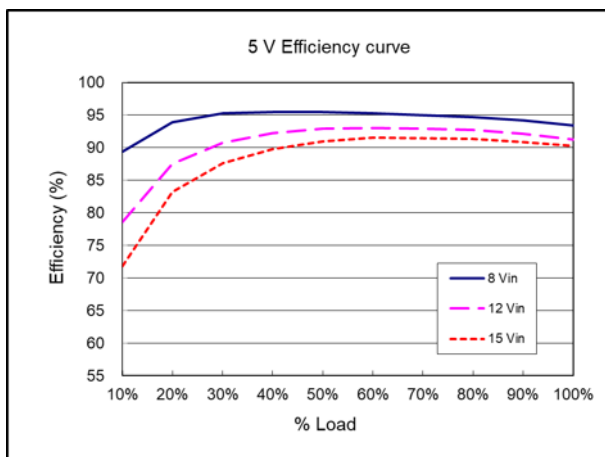

Power dissipation curve ( $V_{nom} = 12.0\text{ V}$ ,  $V_{out} = 3.7\text{ V}$ )

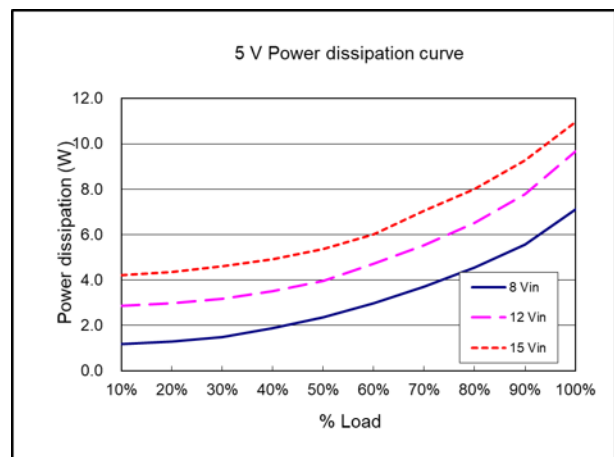

Efficiency curve ( $V_{nom} = 12.0\text{ V}$ ,  $V_{out} = 5.0\text{ V}$ )



Power dissipation curve ( $V_{nom} = 12.0\text{ V}$ ,  $V_{out} = 5.0\text{ V}$ )



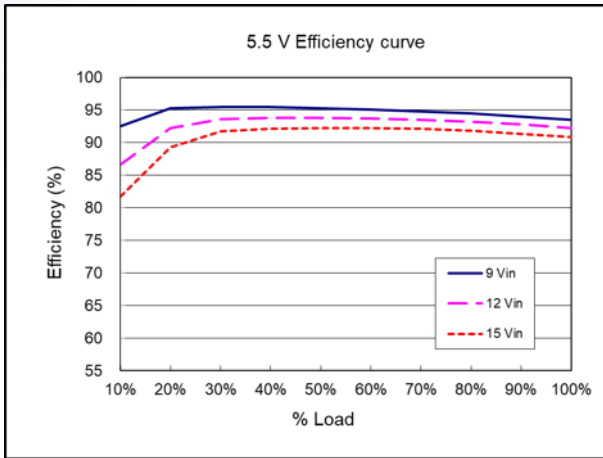

Efficiency curve ( $V_{nom} = 12.0\text{ V}$ ,  $V_{out} = 5.5\text{ V}$ )

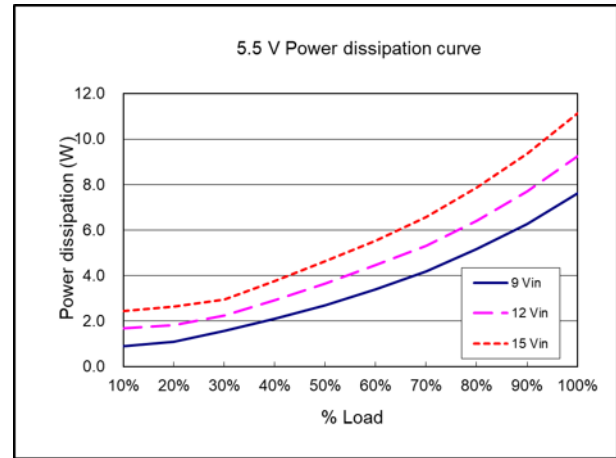

Power dissipation curve ( $V_{nom} = 12.0\text{ V}$ ,  $V_{out} = 5.5\text{ V}$ )

## 3.2 Thermal Considerations

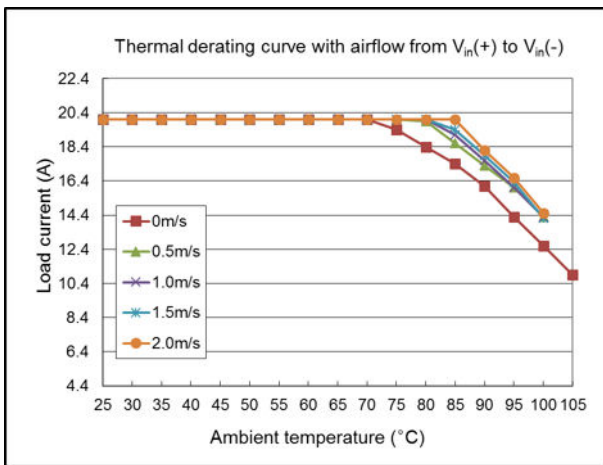

Thermal derating with airflow from  $V_{in}(+)$  to  $V_{in}(-)$  ( $V_{in} = 3.3\text{ V}$ ;  $V_{out} = 0.7\text{ V}$ )

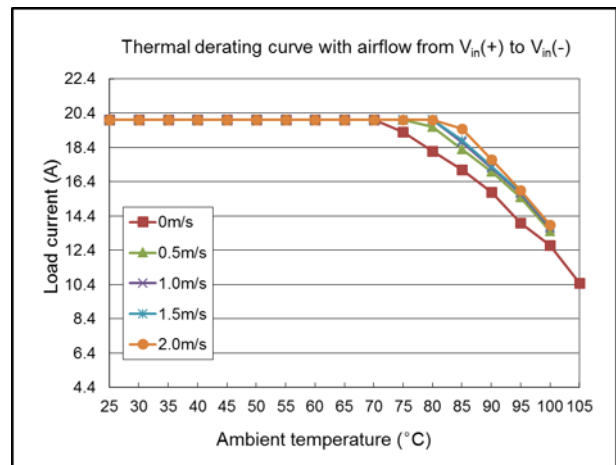

Thermal derating with airflow from  $V_{in}(+)$  to  $V_{in}(-)$  ( $V_{in} = 3.3\text{ V}$ ;  $V_{out} = 0.8\text{ V}$ )

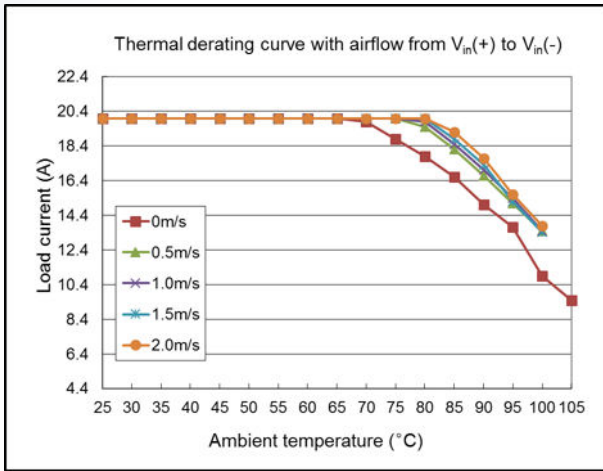

Thermal derating with airflow from  $V_{in}(+)$  to  $V_{in}(-)$  ( $V_{in} = 3.3\text{ V}$ ;  $V_{out} = 0.9\text{ V}$ )

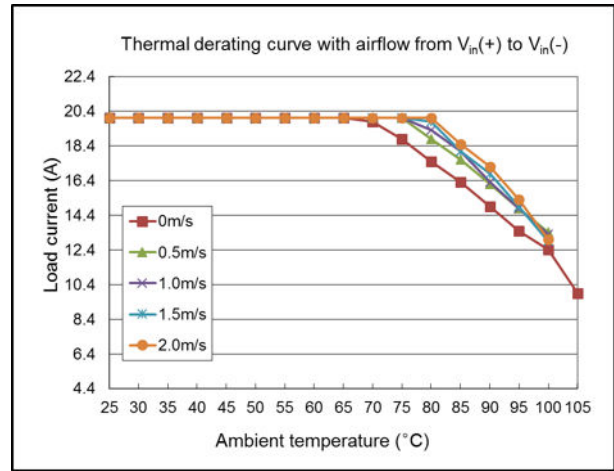

Thermal derating with airflow from  $V_{in}(+)$  to  $V_{in}(-)$  ( $V_{in} = 3.3\text{ V}$ ;  $V_{out} = 1.0\text{ V}$ )

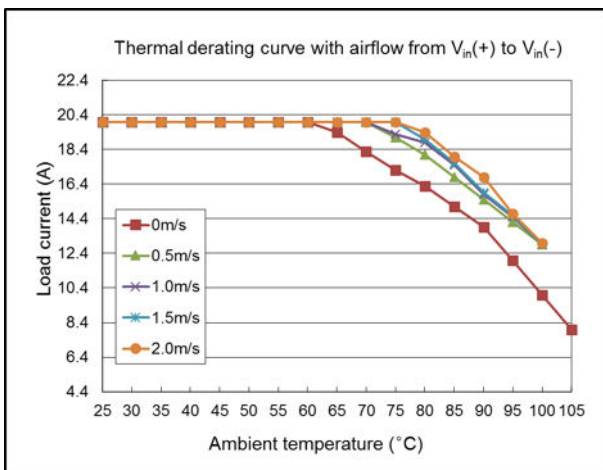

Thermal derating with airflow from  $V_{in}(+)$  to  $V_{in}(-)$  ( $V_{in} = 3.3\text{ V}$ ;  $V_{out} = 1.2\text{ V}$ )

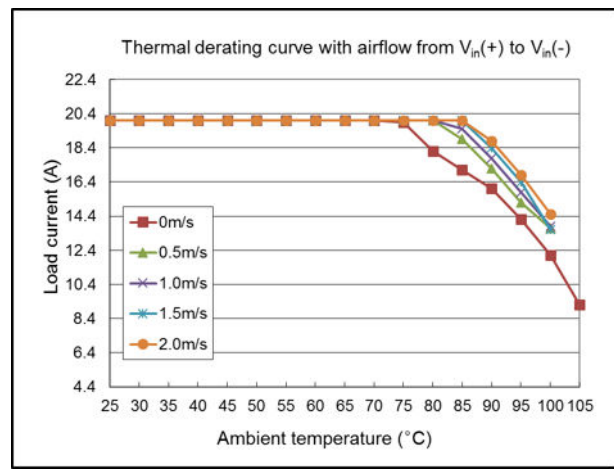

Thermal derating with airflow from  $V_{in}(+)$  to  $V_{in}(-)$  ( $V_{in} = 5.5\text{ V}$ ;  $V_{out} = 0.7\text{ V}$ )

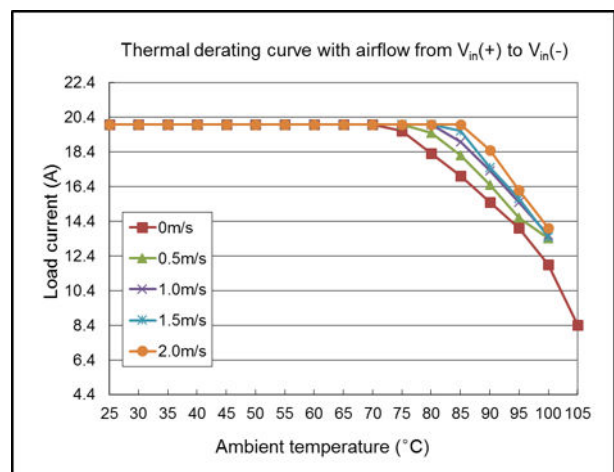
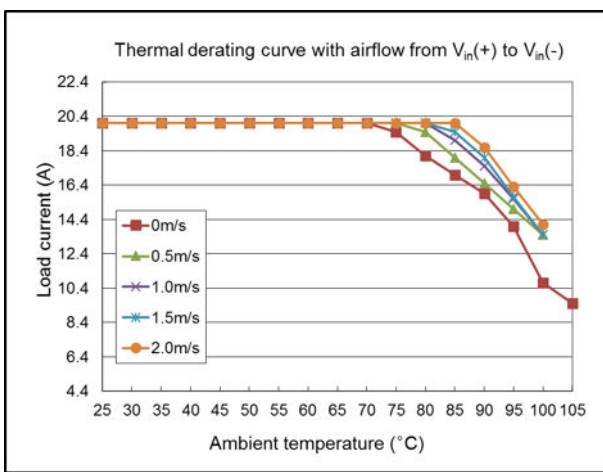

Thermal derating with airflow from  $V_{in}(+)$  to  $V_{in}(-)$  ( $V_{in} = 5.5\text{ V}$ ;  $V_{out} = 0.8\text{ V}$ )

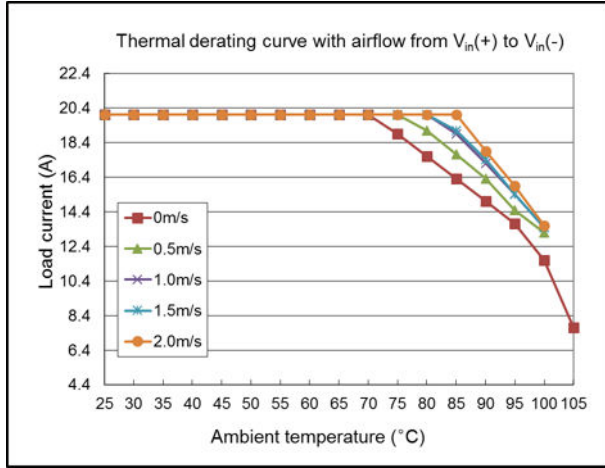

Thermal derating with airflow from  $V_{in}(+)$  to  $V_{in}(-)$  ( $V_{in} = 5.5\text{ V}$ ;  $V_{out} = 0.9\text{ V}$ )

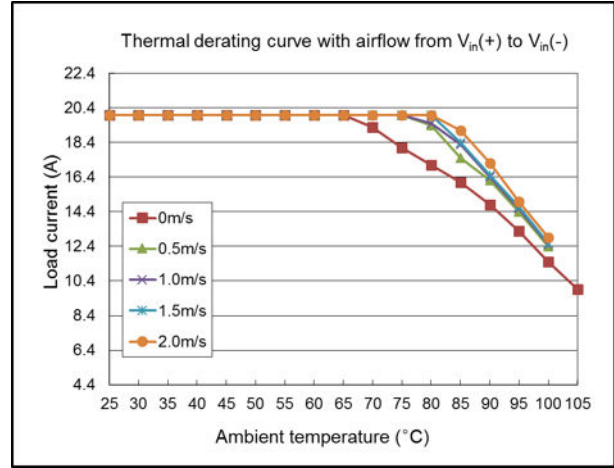

Thermal derating with airflow from  $V_{in}(+)$  to  $V_{in}(-)$  ( $V_{in} = 5.5\text{ V}$ ;  $V_{out} = 1.0\text{ V}$ )

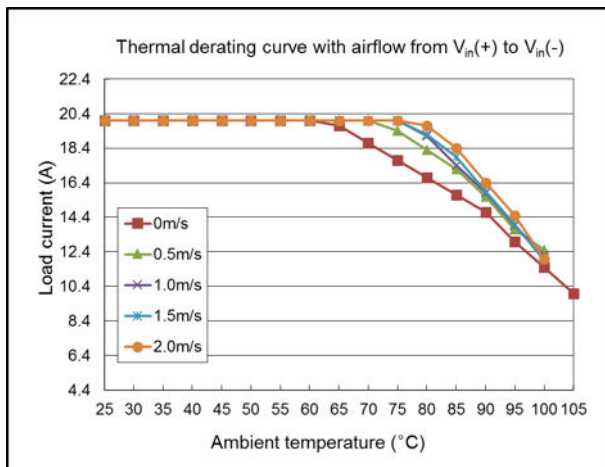

Thermal derating with airflow from  $V_{in}(+)$  to  $V_{in}(-)$  ( $V_{in} = 5.5\text{ V}$ ;  $V_{out} = 1.2\text{ V}$ )

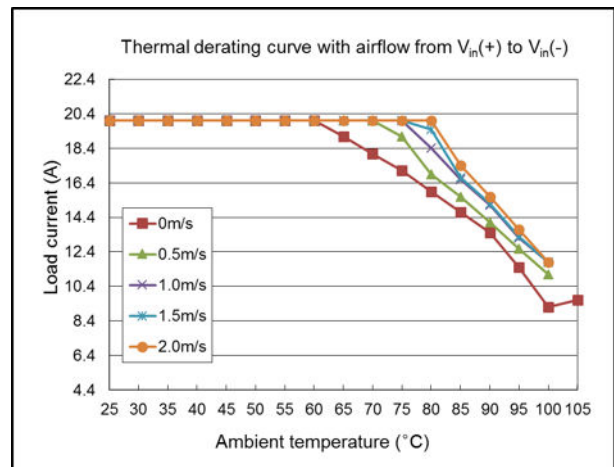

Thermal derating with airflow from  $V_{in}(+)$  to  $V_{in}(-)$  ( $V_{in} = 5.5\text{ V}$ ;  $V_{out} = 1.5\text{ V}$ )

Thermal derating with airflow from  $V_{in}(+)$  to  $V_{in}(-)$  ( $V_{in} = 5.5\text{ V}$ ;  $V_{out} = 1.8\text{ V}$ )



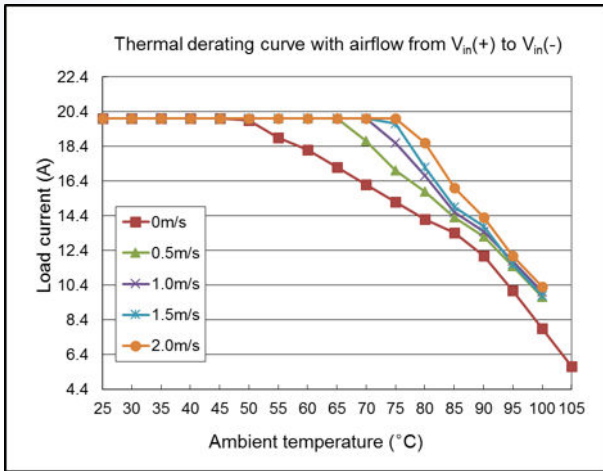

Thermal derating with airflow from  $V_{in}(+)$  to  $V_{in}(-)$  ( $V_{in} = 5.5\text{ V}$ ;  $V_{out} = 2.1\text{ V}$ )

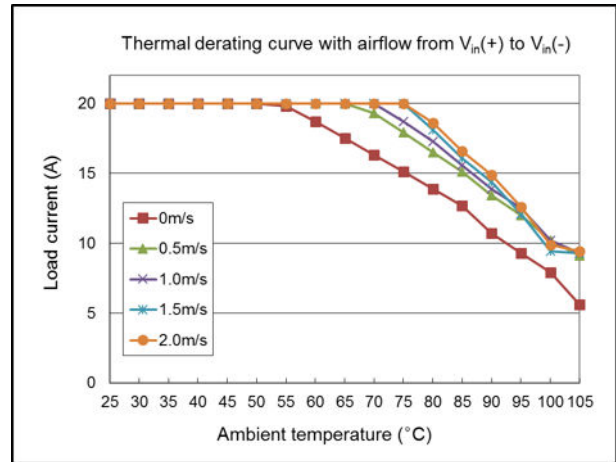

Thermal derating with airflow from  $V_{in}(+)$  to  $V_{in}(-)$  ( $V_{in} = 12\text{ V}$ ;  $V_{out} = 0.7\text{ V}$ )

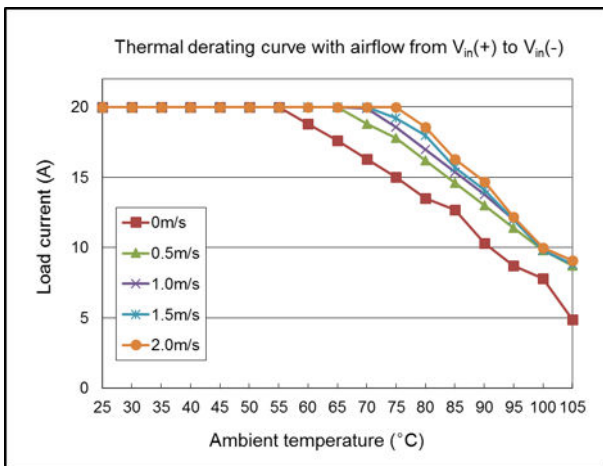

Thermal derating with airflow from  $V_{in}(+)$  to  $V_{in}(-)$  ( $V_{in} = 12\text{ V}$ ;  $V_{out} = 0.8\text{ V}$ )

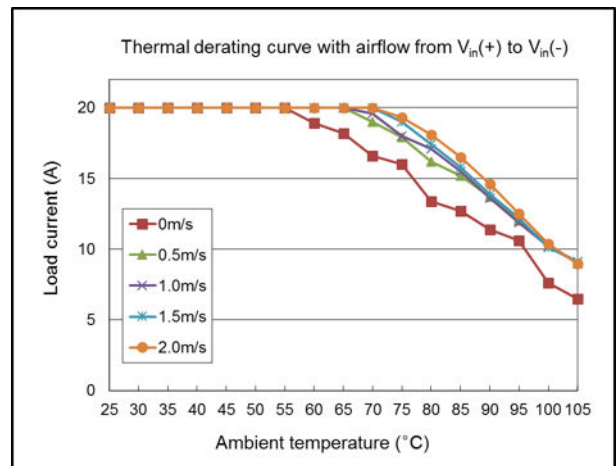

Thermal derating with airflow from  $V_{in}(+)$  to  $V_{in}(-)$  ( $V_{in} = 12\text{ V}$ ;  $V_{out} = 0.9\text{ V}$ )

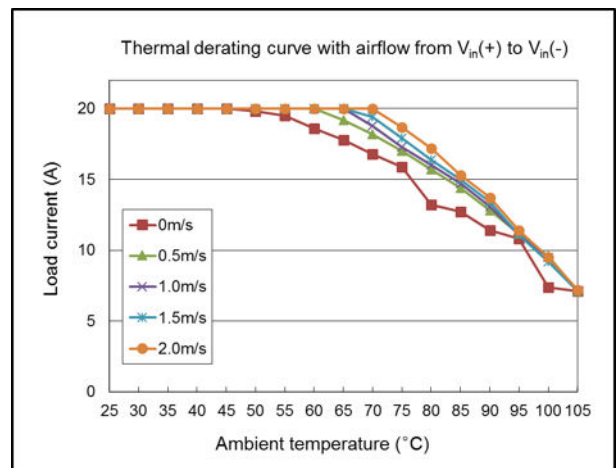
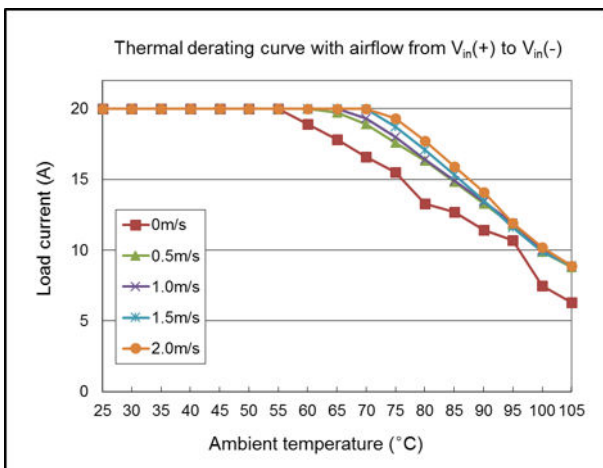

Thermal derating with airflow from  $V_{in}(+)$  to  $V_{in}(-)$  ( $V_{in} = 12\text{ V}$ ;  $V_{out} = 1.0\text{ V}$ )

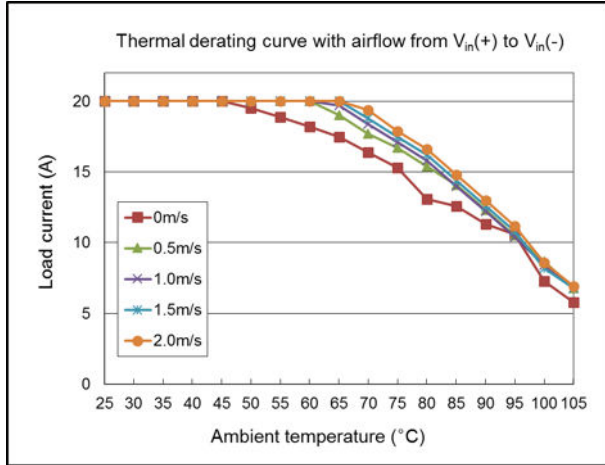

Thermal derating with airflow from  $V_{in}(+)$  to  $V_{in}(-)$  ( $V_{in} = 12\text{ V}$ ;  $V_{out} = 1.2\text{ V}$ )

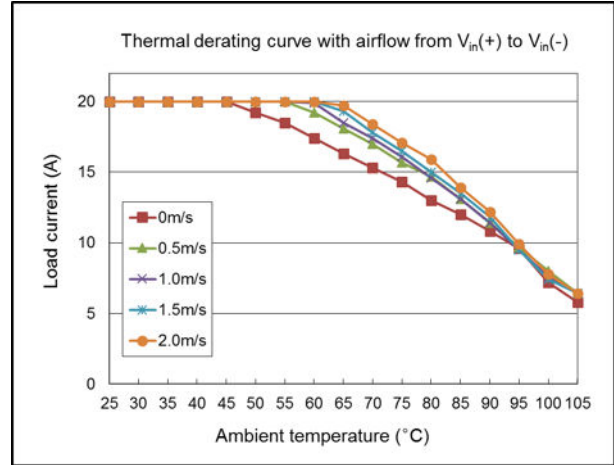

Thermal derating with airflow from  $V_{in}(+)$  to  $V_{in}(-)$  ( $V_{in} = 12\text{ V}$ ;  $V_{out} = 1.5\text{ V}$ )

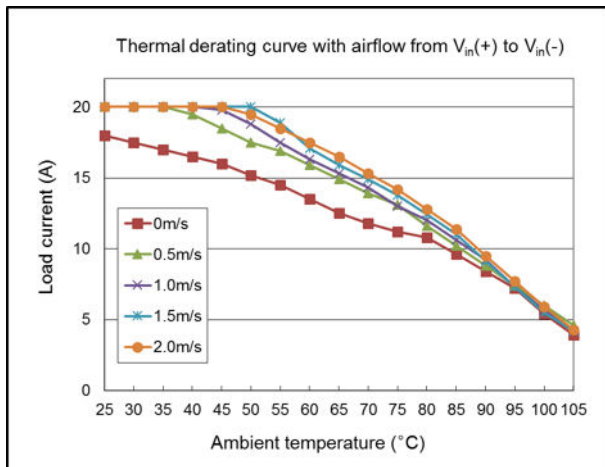

Thermal derating with airflow from  $V_{in}(+)$  to  $V_{in}(-)$  ( $V_{in} = 12\text{ V}$ ;  $V_{out} = 1.8\text{ V}$ )

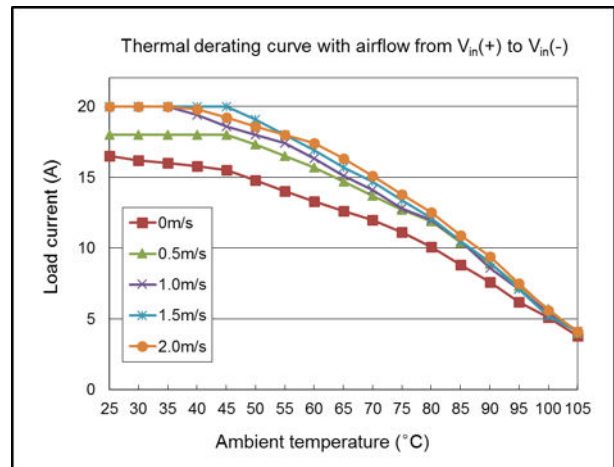

Thermal derating with airflow from  $V_{in}(+)$  to  $V_{in}(-)$  ( $V_{in} = 12\text{ V}$ ;  $V_{out} = 2.1\text{ V}$ )

Thermal derating with airflow from  $V_{in}(+)$  to  $V_{in}(-)$  ( $V_{in} = 12\text{ V}$ ;  $V_{out} = 2.5\text{ V}$ )

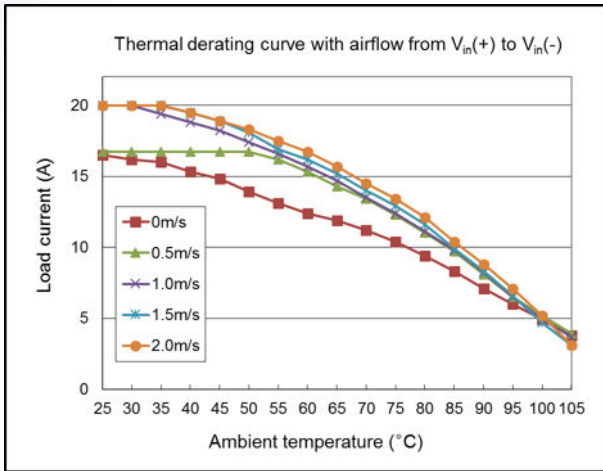

Thermal derating with airflow from  $V_{in}(+)$  to  $V_{in}(-)$  ( $V_{in} = 12\text{ V}$ ;  $V_{out} = 3.3\text{ V}$ )

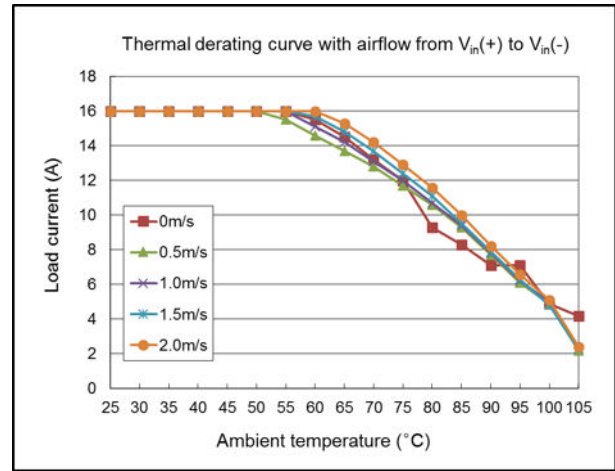

Thermal derating with airflow from  $V_{in}(+)$  to  $V_{in}(-)$  ( $V_{in} = 12\text{ V}$ ;  $V_{out} = 3.7\text{ V}$ )

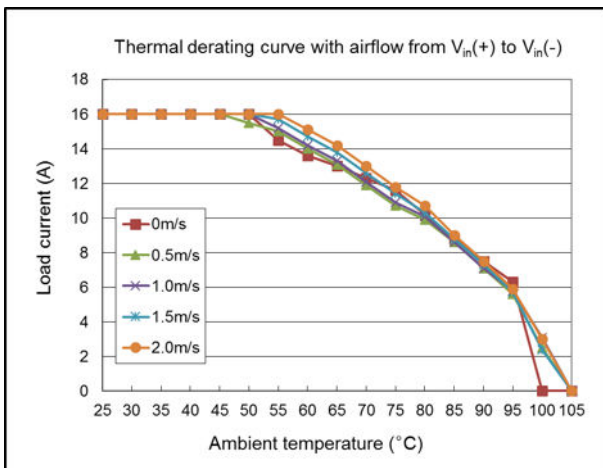

Thermal derating with airflow from  $V_{in}(+)$  to  $V_{in}(-)$  ( $V_{in} = 12\text{ V}$ ;  $V_{out} = 5.0\text{ V}$ )

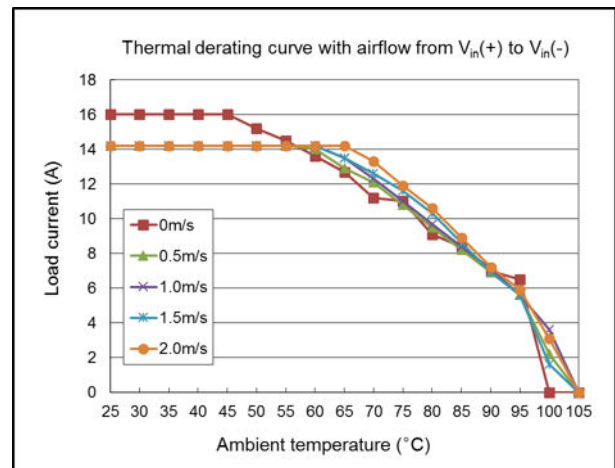

Thermal derating with airflow from  $V_{in}(+)$  to  $V_{in}(-)$  ( $V_{in} = 12\text{ V}$ ;  $V_{out} = 5.5\text{ V}$ )

# 4 Typical Waveforms

### NOTE

1. During the test of input reflected ripple current, the input must be connected to an external input filter (including a 12  $\mu\text{H}$  inductor and a 220  $\mu\text{F}$  electrolytic capacitor), which is not required in other tests.
2. Points B and C are used for testing the output voltage ripple.

## 4.1 Test Setup Diagram & Fundamental Circuit Diagram

Figure 4-1 Test setup diagram

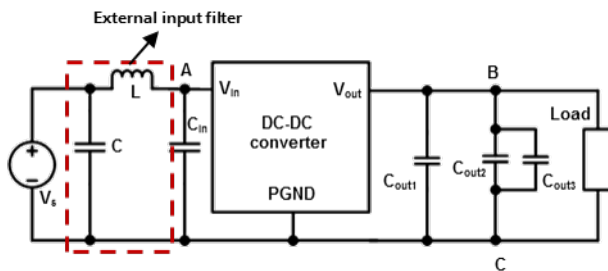

$C_{in}$ : The 30  $\mu\text{F}$  ceramic capacitor and 100  $\mu\text{F}$  polymer aluminum capacitor are recommended.

$C_{out1}$ : Five 47  $\mu\text{F}$  ceramic capacitors are recommended ( $V_{out} \leq 3.7\text{ V}$ ). Fifteen 22  $\mu\text{F}$  ceramic capacitors are recommended ( $V_{out} > 3.7\text{ V}$ ).

$C_{out2}$ : The 0.1  $\mu\text{F}$  ceramic capacitor is recommended.

$C_{out3}$ : The 10  $\mu\text{F}$  ceramic capacitor is recommended.

Figure 4-2 Application circuit

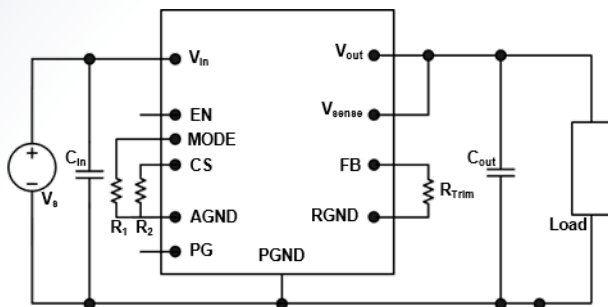

$C_{in}$ : The 30  $\mu\text{F}$  ceramic capacitor and 100  $\mu\text{F}$  polymer aluminum capacitor are recommended.

$C_{out}$ : Five 47  $\mu\text{F}$  ceramic capacitors are recommended ( $V_{out} \leq 3.7\text{ V}$ ). Fifteen 22  $\mu\text{F}$  ceramic capacitors are recommended ( $V_{out} > 3.7\text{ V}$ ).

## 4.2 Turn-on/Turn-off

Conditions:  $T_A = 25^\circ\text{C}$ ,  $V_{in} = 12.0\text{ V}$ , unless otherwise specified

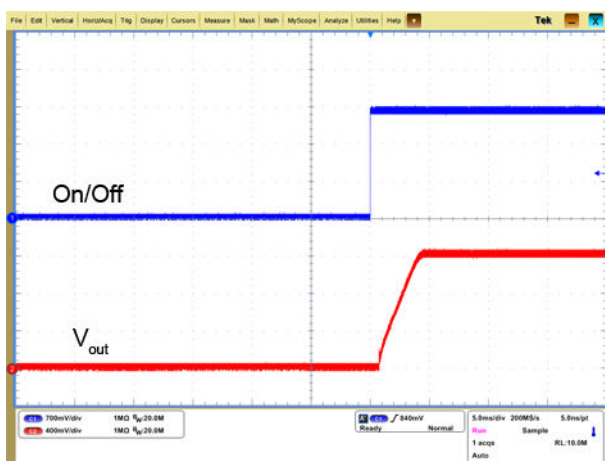

Startup from On/Off

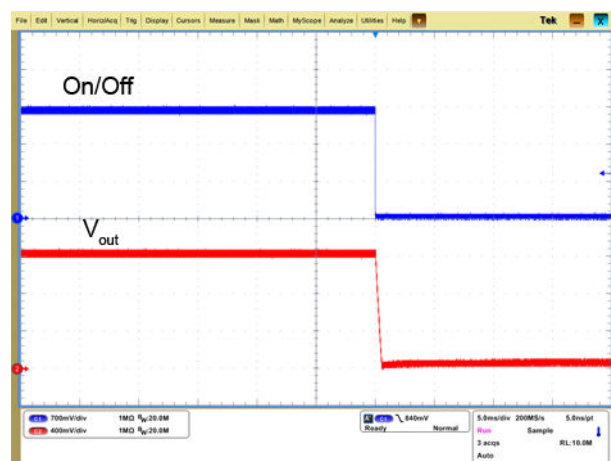

Shutdown from On/Off

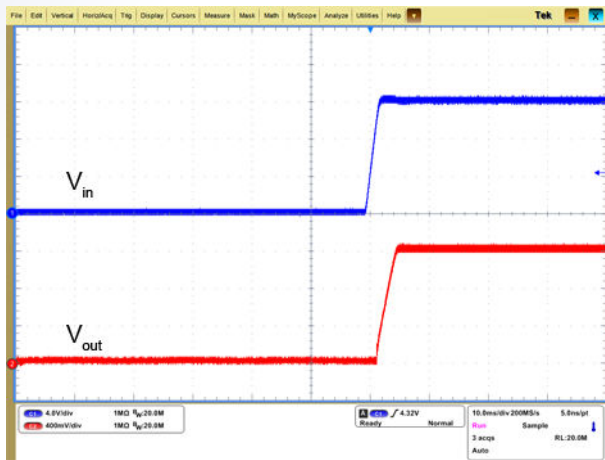

Startup by power-on

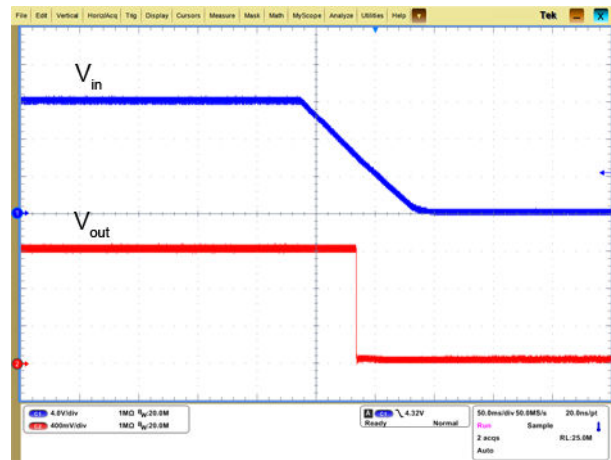

Shutdown by power-off

## 4.3 Output voltage ripple

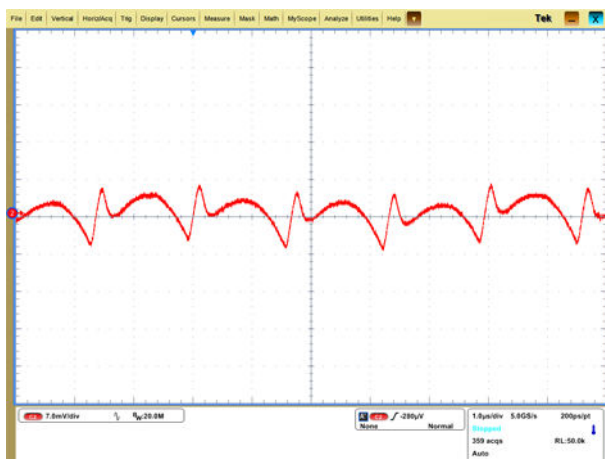

Output voltage ripple (for points B and C in the test set-up diagram,  $T_A = 25^\circ\text{C}$ ,  $V_{in} = 12.0\text{ V}$ ,  $V_{out} = 0.9\text{ V}$ )

## 4.4 Output Voltage Dynamic Response

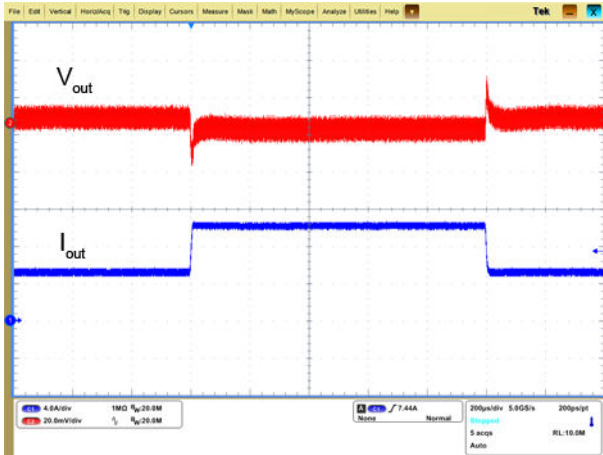

Load: 25%–50%–25%,  $di/dt = 5 \text{ A}/\mu\text{s}$

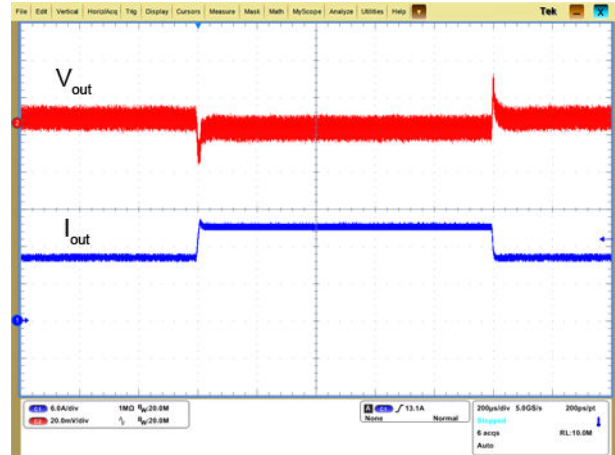

Load: 50%–75%–50%,  $di/dt = 5 \text{ A}/\mu\text{s}$

# 5 Control Features

## 5.1 Remote On/Off

EN Pin Level	Status
Low level	Off
High level	On

It is recommended that the On/Off (EN) pin be controlled using an open collector transistor or a similar device (the EN pin must be connected to the ground through a resistor).

**Figure 5-1** Circuit configuration for On/Off function

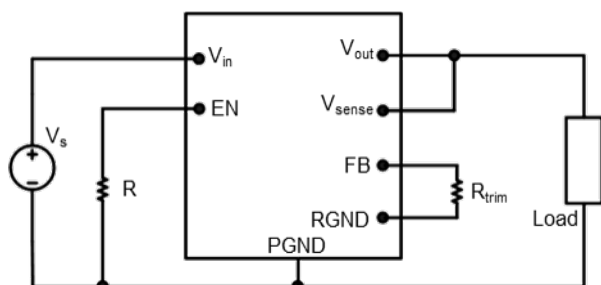

The following table describes the mapping between  $V_{in}$  and  $R$ .

$V_{in}$ (V)	$R$ (k $\Omega$ )
3.3	7.50
5.5	4.02
12.0	2.00



## 5.2 Output Voltage Trim

The output voltage can be adjusted by connecting an external resistor between the Trim (FB) pin and the RGND pin.

**Figure 5-2**  $R_{trim}$  external connections

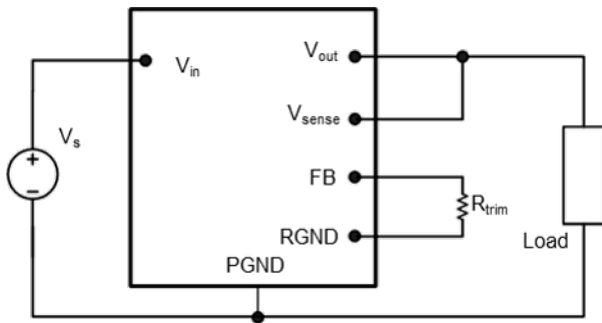

Relationship between  $R_{trim}$  and  $V_{out}$ :

$$R_{trim} = \left[ \frac{1.2}{V_{out} - 0.6} \right] k\Omega$$

### NOTE

The output voltage varies depending on  $R_{trim}$ . Note that the trim resistor tolerance directly affects the output voltage accuracy. The following table describes the mapping between  $V_{out}$  and  $R_{trim}$ .

$V_{out}$ (V)	$R_{trim}$ (k $\Omega$ )
0.6	-
0.7	12.000
0.8	6.000
0.9	4.000
1.0	3.000
1.2	2.000
1.5	1.333
1.8	1.000
2.5	0.632
3.3	0.444
3.7	0.387

$V_{out}$ (V)	$R_{trim}$ (k $\Omega$ )
5.0	0.273
5.5	0.245

## 5.3 Power Good Signal (PG)

The power good (PG) signal is pulled up to VCC or a fixed level 0.8–4.0 V through a resistor when in use. If the PG function is not required, the pin is left open.

**Figure 5-3** Configuration diagram of PG

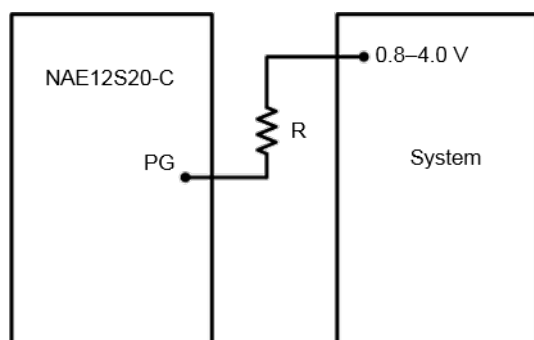

R: The 10 k $\Omega$  resistance is recommended.

# 6 Protection Features

---

## Input Undervoltage Protection

The converter will shut down if the input voltage drops below the undervoltage protection threshold. The converter will start to work again if the input voltage reaches the input undervoltage recovery threshold.

## Output Overcurrent Protection

The converter equipped with current limiting circuitry can provide protection from an output overload or short circuit condition. If the output current exceeds the output overcurrent protection set point, the converter enters hiccup mode. When the fault condition is removed, the converter will automatically restart.

## Output Overvoltage Protection

If the output voltage exceeds the output overvoltage protection threshold, the converter will enter protection mode. When the fault is rectified, the converter will automatically restart.

## Overtemperature Protection

A temperature sensor on the converter senses the average temperature of the converter. It protects the converter from being damaged at high temperatures. When the temperature exceeds the overtemperature protection threshold, the output will shut down. It will allow the converter to turn on again when the temperature of the sensed location falls by the value of the overtemperature protection hysteresis.

# 7 Qualification Testing

**Table 7-1** Device level test items

No.	Test Item	Units	Test Condition
1	Pre-condition	-	Visual inspection → Electrical test → C-SCAN/X-RAY → Bake (125°C, 24 h) → Moisture soaking → Reflow (3 cycles, 260°C) → Visual inspection → Electrical test → C-SCAN/X-RAY.
2	High temperature storage life test	77 pcs/3 lot	125°C, 1000 h
3	Temperature cycling	77 pcs/3 lot	1000 temperature cycles between -55°C and +125°C, 500/700/1000 cycles with no power on
4	ESD	3 pcs	HBM 2000 V, CDM 500 V
5	Solderability	22 Leads	Steam aging: 8 hours, Pb-free: 240–250°C, 4.5–5.5s
6	Unbiased highly accelerated stress test	77 pcs/3 lot	130°C/110°C, 85% RH, 96 h/264 h
7	Highly accelerated stress test	77 pcs/3 lot	130°C/110°C, 85% RH, Vcc, 96 h/264 h
8	Temperature humidity bias	77 pcs/3 lot	85°C, 85% RH, Vcc, 1200 operating hours
9	High temperature operating life test	77 pcs/3 lot	Input voltage: Vcc Ambient temperature: Defined by usage scenario; Output loading: Defined by junction temperature and derating requirements; On-off (1hour): on30->off1 >on9->off10->on1->off1 -> on1 >off1 ->on1 -> off1 -> on1-> off1-> on1 ->off1; Function monitor: continuous or sampled ≤ once a minute

No.	Test Item	Units	Test Condition
10	Power and temperature cycling test	77 pcs/3 lot	Input voltage: Vcc; Ambient temperature: Defined by usage scenario; Output loading: Defined by junction temperature and derating requirements; Temperature transforming rate : 10-20°C/min; Power-temperature cycle is designed as the following picture, notes:T1=4.5min-> T2+T3+T4=36min-> T5=6.5min->T6+T7=36min-> T8=6.5min
11	Highly accelerated life test	5-10 pcs	20 Hz to 2 kHz (log variation) in > 4 minutes, 4X in each orientation, 40G peak acceleration
12	Dendrite test	10 pcs/1 lot	High temperature (close to OTP protection working temperature) with full load, 9 days with no power off and no dendrite under 50X microscope
13	Withstand mechanical strength (for module)	33 pcs/3 lots	No thermal conductive pad. Test method refers to that of magnetic device.
14	Salt fog	16 pcs/1 lot	Classification C for 5 years: 2% NaCl, 90% RH, 35°C, 20 days
15	Damp dust	16 pcs/1 lot	Classification B for 10 years: Dust for 6 days (30 mg/m <sup>3</sup> ) - steady damp heat test for 12 days (95% RH, 40°C) - cyclic damp heat test for 4 days (25-40°C, 95% RH)
16	Shadow moire - High temp deformation test	3 pcs	≤ 0.08mm (leadless package), temperature range: 25-300°C

**Table 7-2** Board level test items

Index	Test Item	Units	Test Condition
1	Withstand mechanical strength (for solder)	24 pcs/1 lot	The vertical movement speed: 25.4 mm/min. Evaluation based on 70% of compression of super soft thermal conductive pad.
2	Board level drop test - daisy chain	20 pcs/1 lot	0.5 ms duration, 1500 g peak acceleration, 30 drops or 80% of failure

Index	Test Item	Units	Test Condition
3	Board level TCT - daisy chain	32 pcs/1 lot	-40-125°C, number: 1000 cycles. No power on, ramping rate 10~20°C/min
4	Bending	24 pcs/1 lot	4 Point bending test, 1 mm/min

# 8 EMC Specifications

Table 8-1

Items	Standard	Level
CE	EN 55022	Class A
ESD	IEC/EN61000-4-2	Level 3
EFT	IEC/EN61000-4-4	Level 3
SURGE	IEC/EN61000-4-5	0.6 kV
Conducted disturbances immunity	IEC/EN61000-4-6	Level 2
DC voltage dips, short interruption, variation	EN61000-4-29	-

# 9 Thermal Consideration

## Thermal Test Point

Sufficient airflow should be provided to ensure reliable operating of the converter. Therefore, thermal components are mounted on the top surface of the converter to dissipate heat to the surrounding environment by conduction, convection, and radiation. Proper airflow can be verified by measuring the temperature at the surface of the converter.

**Figure 9-1** Thermal test point

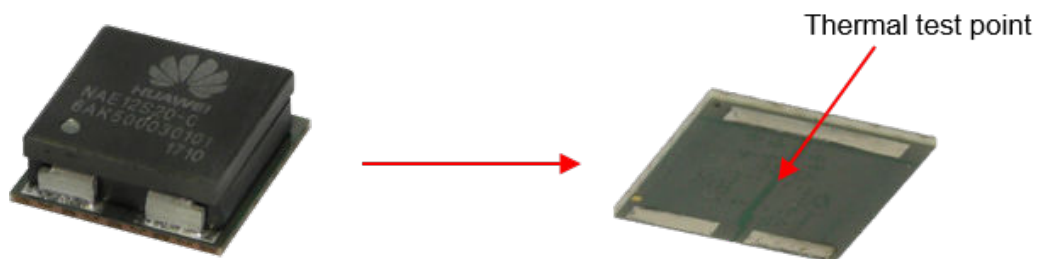

## Power Dissipation

The converter power dissipation is calculated based on efficiency. The following formula reflects the relationship between the consumed power ( $P_d$ ), efficiency ( $\eta$ ), and output power ( $P_o$ ):  $P_d = P_o (1 - \eta)/\eta$ .



# 10 Package Information

**Figure 10-1** Encapsulation Size Diagram

Unit of measurement: mm (in.)

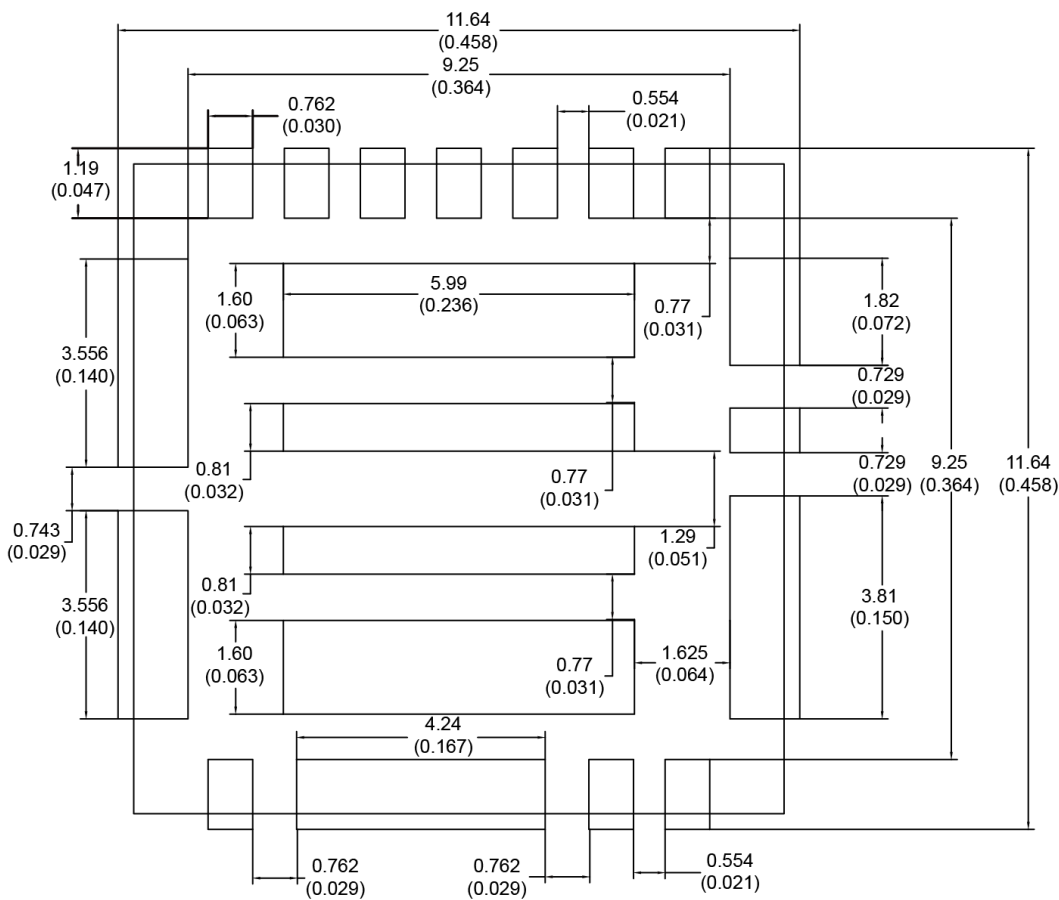

The converter is supplied in tape and reel packaging. The following figure shows the tape dimensions.

Unit of measurement: mm

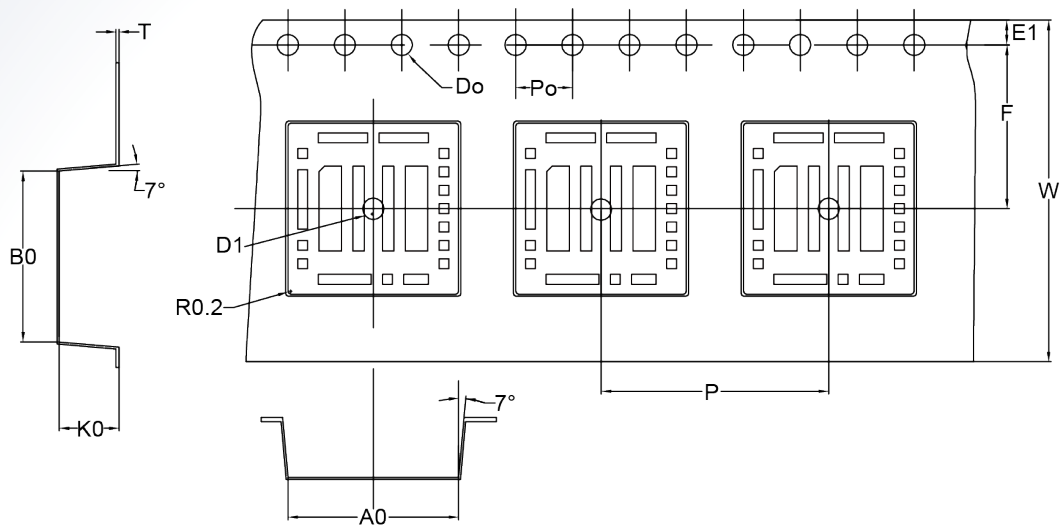

<b>Item</b>	W	A0	B0	K0	P0	E
<b>Spec.</b>	24.00 <sup>+0.20</sup> <sub>-0.20</sub>	11.50 <sup>+0.10</sup> <sub>-0.10</sub>	11.50 <sup>+0.10</sup> <sub>-0.10</sub>	4.20 <sup>+0.10</sup> <sub>-0.10</sub>	4.00 <sup>+0.10</sup> <sub>-0.10</sub>	1.75 <sup>+0.10</sup> <sub>-0.10</sub>
<b>Item</b>	F	D0	D1	P1	P2	T
<b>Spec.</b>	11.50 <sup>+0.05</sup> <sub>-0.05</sub>	1.55 <sup>+0.05</sup> <sub>-0.05</sub>	1.55 <sup>+0.05</sup> <sub>-0.05</sub>	16.00 <sup>+0.10</sup> <sub>-0.10</sub>	2.00 <sup>+0.05</sup> <sub>-0.05</sub>	0.40 <sup>+0.05</sup> <sub>-0.05</sub>

#### NOTE

- Carrier camber does not exceed 1 mm in 100 mm.
- Cumulative tolerance of 10 sprocket hole pitch: ±0.2 mm.
- Material: Blank anti-static PS 0.4 mm thick.
- All type and sprocket hole dimensioning are as per EIA-481 unless otherwise stated.
- A0 and B0 are measured on a place in the middle of the corner radii.

# 11 Mechanical Consideration

## Surface Mount Information

The converter uses a PSiP structure and is designed for a fully automated assembly process.

The flat surface of the label on the large inductor can be the patch mounting surface. The converter weight can be borne by a standard surface mount device (SMD). For most SMDs, the converter is heavy, and mounting on the capacitor surface will cause deviation. The solution is to optimize the model and size of the suction nozzle and increase the mounting speed and vacuum pressure.

The label meets all the requirements for surface mount processing, as well as safety standards, and is able to withstand reflow temperatures of up to 300°C. The label also carries product information such as product code and manufacturing date.

## Soldering

The converter supports reflow soldering techniques. Wave soldering and hand soldering are not allowed. During the reflow process, the peak temperature must not exceed 260°C at any time.

Figure 11-1 Recommended reflow profile using lead-free solder

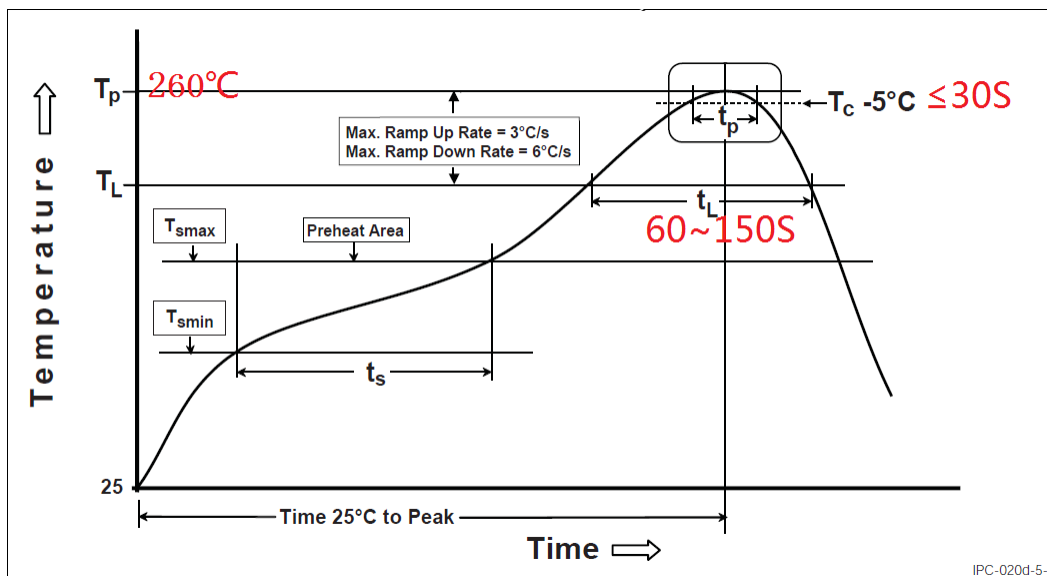

### Moisture Resistance Requirements

Store and transport the converter as required by the MSL rating 3 specified in the IPC/JEDEC J-STD-033.

The surface of a soldered converter must be clean and dry. Otherwise, the assembly, test, or even reliability of the converter will be negatively affected.



**Copyright © Huawei Technologies Co., Ltd. 2020. All rights reserved.**

No part of this document may be reproduced or transmitted in any form or by any means without prior written consent of Huawei Technologies Co., Ltd.

### **Trademarks and Permissions**



HUAWEI and other Huawei trademarks are trademarks of Huawei Technologies Co., Ltd.

All other trademarks and trade names mentioned in this document are the property of their respective holders.

### **Notice**

The purchased products, services and features are stipulated by the contract made between Huawei and the customer. All or part of the products, services and features described in this document may not be within the purchase scope or the usage scope. Unless otherwise specified in the contract, all statements, information, and recommendations in this document are provided "AS IS" without warranties, guarantees or representations of any kind, either express or implied.

The information in this document is subject to change without notice. Every effort has been made in the preparation of this document to ensure accuracy of the contents, but all statements, information, and recommendations in this document do not constitute a warranty of any kind, express or implied.

**Huawei Technologies Co., Ltd.**

Huawei Industrial Base  
Bantian, Longgang  
Shenzhen 518129  
People's Republic of China

**[www.huawei.com](http://www.huawei.com)**