



P-DUKE POWER

PDL06 Series

DC-DC Converter
Up to 6 Watts

3

YEARS
WARRANTY

ROHS
COMPLIANT

REACH
COMPLIANT

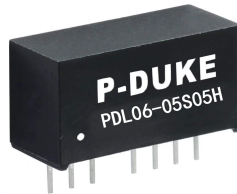

Automation



Datacom



IPC



Industry



Measurement



Telecom



Automobile



Boat



Charger



Medical



PV



Railway



3000
VDC
Isolation
Voltage

1600
VDC
Isolation
Voltage

2 : 1
Input
Range

NO
Min. Load
Required

REMOTE
ON
OFF

SCP

UVP

PART NUMBER STRUCTURE

PDL06 -	48	S	05	H
Series Name	Input Voltage (VDC)	Output Quantity	Output Voltage (VDC)	Case & Isolation Options
	05:4.5~9 12:9~18 24:18~36 48:36~75	S:Single D:Dual	3P3:3.3 05:5 09:9 12:12 15:15 24:24 05:±5 12:±12 15:±15	□:Standard type Plastic case 1600VDC isolation H:Plastic case 3000VDC isolation M:Metal case 1600VDC isolation

TECHNICAL SPECIFICATION All specifications are typical at nominal input, full load and 25°C unless otherwise noted

Model Number	Input Range	Output Voltage	Output Current @ Full Load	Input Current @ No Load	Efficiency	Maximum Capacitor Load
	VDC	VDC	mA	mA	%	μF
PDL06-05S3P3	4.5 ~ 9	3.3	1300	65	77	6600
PDL06-05S05	4.5 ~ 9	5	1200	105	81	3300
PDL06-05S09	4.5 ~ 9	9	666	105	83	2000
PDL06-05S12	4.5 ~ 9	12	500	105	84	1600
PDL06-05S15	4.5 ~ 9	15	400	105	84	1400
PDL06-05S24	4.5 ~ 9	24	250	105	84	680
PDL06-05D05	4.5 ~ 9	±5	±600	105	81	±2000
PDL06-05D12	4.5 ~ 9	±12	±250	105	84	±900
PDL06-05D15	4.5 ~ 9	±15	±200	105	84	±660
PDL06-12S3P3	9 ~ 18	3.3	1300	40	78	6600
PDL06-12S05	9 ~ 18	5	1200	55	83	3300
PDL06-12S09	9 ~ 18	9	666	55	85	2000
PDL06-12S12	9 ~ 18	12	500	55	85	1600
PDL06-12S15	9 ~ 18	15	400	55	85	1400
PDL06-12S24	9 ~ 18	24	250	55	84	680
PDL06-12D05	9 ~ 18	±5	±600	55	82	±2000
PDL06-12D12	9 ~ 18	±12	±250	55	84	±900
PDL06-12D15	9 ~ 18	±15	±200	55	85	±660
PDL06-24S3P3	18 ~ 36	3.3	1300	20	78	6600
PDL06-24S05	18 ~ 36	5	1200	28	83	3300
PDL06-24S09	18 ~ 36	9	666	28	85	2000
PDL06-24S12	18 ~ 36	12	500	28	86	1600
PDL06-24S15	18 ~ 36	15	400	28	86	1400
PDL06-24S24	18 ~ 36	24	250	28	85	680
PDL06-24D05	18 ~ 36	±5	±600	28	82	±2000
PDL06-24D12	18 ~ 36	±12	±250	28	85	±900
PDL06-24D15	18 ~ 36	±15	±200	28	85	±660
PDL06-48S3P3	36 ~ 75	3.3	1300	14	78	6600
PDL06-48S05	36 ~ 75	5	1200	14	82	3300
PDL06-48S09	36 ~ 75	9	666	14	84	2000
PDL06-48S12	36 ~ 75	12	500	14	85	1600
PDL06-48S15	36 ~ 75	15	400	14	86	1400
PDL06-48S24	36 ~ 75	24	250	14	84	680
PDL06-48D05	36 ~ 75	±5	±600	14	82	±2000
PDL06-48D12	36 ~ 75	±12	±250	14	84	±900
PDL06-48D15	36 ~ 75	±15	±200	14	85	±660

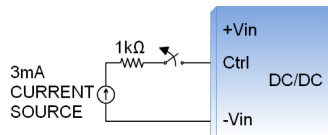
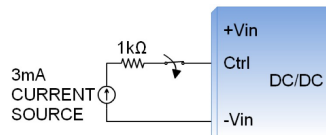
INPUT SPECIFICATIONS						
Parameter	Conditions		Min.	Typ.	Max.	Unit
Operating input voltage range	5Vin(nom)		4.5	5	9	VDC
	12Vin(nom)		9	12	18	
	24Vin(nom)		18	24	36	
	48Vin(nom)		36	48	75	
Start up voltage	5Vin(nom)				4.5	VDC
	12Vin(nom)				9	
	24Vin(nom)				18	
	48Vin(nom)				36	
Shutdown voltage	5Vin(nom)		2	3.5	4	VDC
	12Vin(nom)		5	7	8	
	24Vin(nom)		12	15	17	
	48Vin(nom)		26	33	35	
Start up time	Constant resistive load	Power up		5	10	ms
		Remote ON/OFF		5	10	
Input surge voltage	1 second, max.	5Vin(nom)			15	VDC
		12Vin(nom)			36	
		24Vin(nom)			50	
		48Vin(nom)			100	
Input filter			Capacitor type			
Remote ON/OFF	Ctrl pin applied current via 1k Ω	DC-DC ON			Open or high impedance	
		DC-DC OFF	2	3	4	mA
		Remote off input current			2.5	mA
Application circuit		DC-DC ON				
		DC-DC OFF				

OUTPUT SPECIFICATIONS						
Parameter	Conditions		Min.	Typ.	Max.	Unit
Voltage accuracy			-1.0		+1.0	%
Line regulation	Low Line to High Line at Full Load		-0.2		+0.2	%
Load regulation	No Load to Full Load	Single	-1.0		+1.0	%
		Dual	-1.0		+1.0	%
Cross regulation	Asymmetrical load 25%/100% FL	Dual	-5.0		+5.0	%
Ripple and noise	20MHz bandwidth			50		mVp-p
Temperature coefficient			-0.02		+0.02	%/°C
Transient response recovery time	25% load step change			500		μ s
Short circuit protection			Continuous, automatic recovery			

GENERAL SPECIFICATIONS							
Parameter	Conditions			Min.	Typ.	Max. Unit	
Isolation voltage	1 minute	Input to Output	Standard Type	1600		VDC	
			Suffix "H"	3000			
		Suffix "M"	1600				
	Input (Output) to Case	Suffix "M"	1000				
Isolation resistance	500VDC			1		GΩ	
Isolation capacitance						50	
						50	pF
						50	
Switching frequency	Full load to minimum load			100		kHz	
Safety approvals	IEC/ EN/ UL62368-1					UL:E193009 CB:UL(Demko)	
Case material						Non-conductive black plastic	
						Non-conductive black plastic	
						Copper	
Base material						None	
Potting material						Silicone (UL94 V-0)	
Weight						4.8g (0.17oz)	
						4.8g (0.17oz)	
						5.9g (0.21oz)	
MTBF	MIL-HDBK-217F		Standard Type			2.135 x 10 ⁶ hrs	
			Suffix "H"			2.135 x 10 ⁶ hrs	
			Suffix "M"			2.360 x 10 ⁶ hrs	

ENVIRONMENTAL SPECIFICATIONS						
Parameter	Conditions			Min.	Typ.	Max. Unit
Operating ambient temperature	Standard type		With derating	-40		+90
	Suffix "H"		With derating	-40		+90
	Suffix "M"		With derating	-40		+95
Maximum case temperature						105 °C
Storage temperature range				-55		+125 °C
Thermal shock						MIL-STD-810F
Vibration						MIL-STD-810F
Relative humidity						5% to 95% RH

EMC SPECIFICATIONS			
Parameter	Conditions		Level
EMI	EN55032	With external components	Class A · Class B
EMS	EN55024		
ESD	EN61000-4-2	Air ± 8kV and Contact ± 6kV	Perf. Criteria A
Radiated immunity	EN61000-4-3	10 V/m	Perf. Criteria A
Fast transient	EN61000-4-4	± 2kV	Perf. Criteria A
	5 VDC input	With an external input filter capacitor (Nippon chemi-con KY series, 330µF/50V)	
	Others	With an external input filter capacitor (Nippon chemi-con KY series, 220µF/100V.)	
Surge	EN61000-4-5	±1kV	Perf. Criteria A
	5 VDC input	With an external input filter capacitor (Nippon chemi-con KY series, 330µF/50V)	
	Others	With an external input filter capacitor (Nippon chemi-con KY series, 220µF/100V.)	
Conducted immunity	EN61000-4-6	10 Vr.m.s	Perf. Criteria A
Power frequency magnetic field	EN61000-4-8	100A/m continuous; 1000A/m 1 second	Perf. Criteria A

CAUTION: This power module is not internally fused. An input line fuse must always be used.

CHARACTERISTIC CURVE

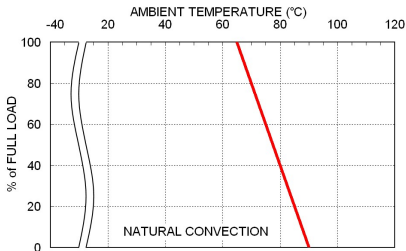

PDL06-48S05 Derating Curve

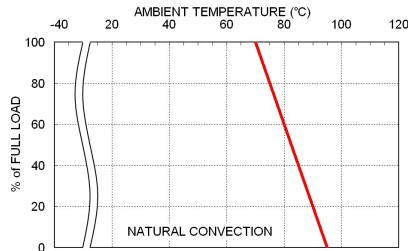

PDL06-48S05M Derating Curve

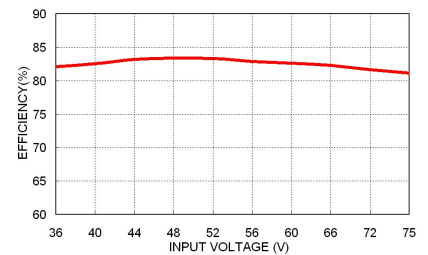

PDL06-48S05 Efficiency vs. Input Voltage

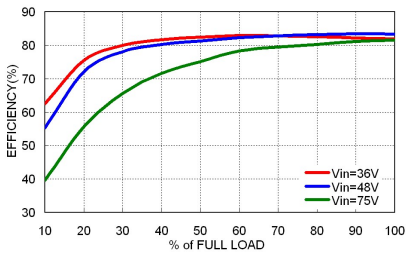

PDL06-48S05 Efficiency vs. Output Load

FUSE CONSIDERATION

This power module is not internally fused. An input line fuse must always be used.

This encapsulated power module can be used in a wide variety of applications, ranging from simple stand-alone operation to an integrated part of sophisticated power architecture.

To maximum flexibility, internal fusing is not included; however, to achieve maximum safety and system protection, always use an input line fuse.

The input line fuse suggest as below :

Model	Fuse Rating (A)	Fuse Type
PDL06-05S□□、PDL06-05D□□	3	Slow-Blow
PDL06-12S□□、PDL06-12D□□	1.6	Slow-Blow
PDL06-24S□□、PDL06-24D□□	1	Slow-Blow
PDL06-48S□□、PDL06-48D□□	0.5	Slow-Blow

The table based on the information provided in this data sheet on inrush energy and maximum DC input current at low Vin.

MECHANICAL DRAWING

Standard type, Suffix “H”

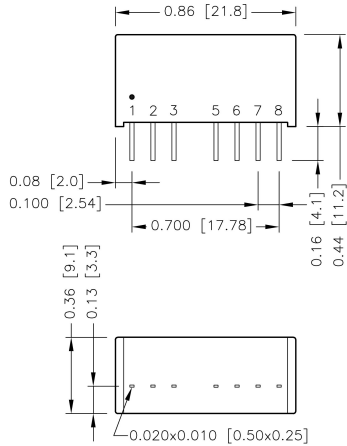

BOTTOM VIEW

Suffix “M”

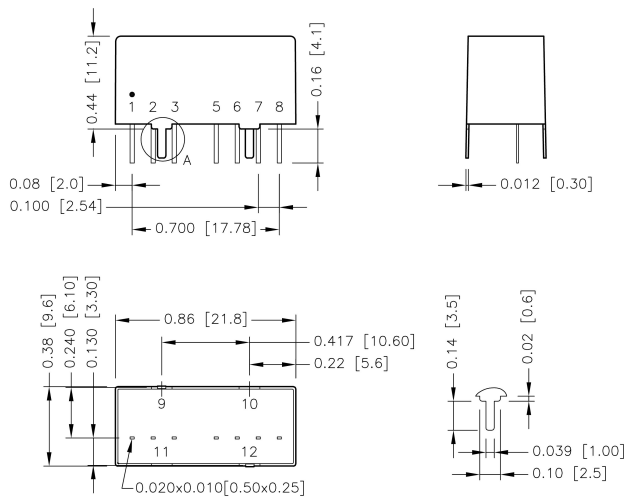

BOTTOM VIEW

A VIEW

PIN CONNECTION

PIN	SINGLE	DUAL
1	-Vin	-Vin
2	+Vin	+Vin
3	Ctrl	Ctrl
5	NC*/No pin**	NC*/No pin**
6	+Vout	+Vout
7	-Vout	Common
8	NC	-Vout

*NC pin for standard type model.

**No pin for 3kVDC isolation model (suffix “H”).

1. All dimensions in inch [mm]
2. Tolerance :x.xx±0.02 [x.x±0.5]
x.xxx±0.01 [x.xx±0.25]
3. Pin dimension tolerance ±0.004 [0.10]

PIN CONNECTION

PIN	SINGLE	DUAL
1	-Vin	-Vin
2	+Vin	+Vin
3	Ctrl	Ctrl
5	NC	NC
6	+Vout	+Vout
7	-Vout	Common
8	NC	-Vout
9	Case	Case
10	Stand off	Stand off
11	Stand off	Stand off
12	Case	Case

1. All dimensions in inch [mm]
2. Tolerance :x.xx±0.02 [x.x±0.5]
x.xxx±0.01 [x.xx±0.25]
3. Pin dimension tolerance ±0.004 [0.10]

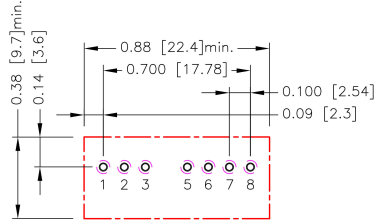
RECOMMENDED PAD LAYOUT
Standard type, Suffix "H"

All dimensions in inch[mm]
 Pad size(lead free recommended)
 Through hole 1.2.3.5.6.7.8: $\Phi 0.031[0.80]$
 Top view pad 1.2.3.5.6.7.8: $\Phi 0.039[1.00]$
 Bottom view pad 1.2.3.5.6.7.8: $\Phi 0.063[1.60]$

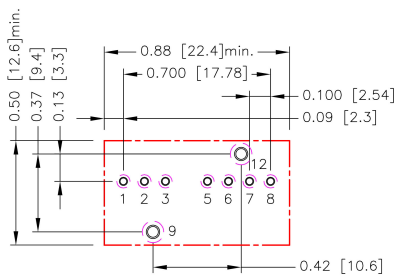
Suffix "M"

All dimensions in inch[mm]
 Pad size(lead free recommended)
 Through hole 1.2.3.5.6.7.8: $\Phi 0.031[0.80]$
 Through hole 9.12: $\Phi 0.051[1.30]$
 Top view pad 1.2.3.5.6.7.8: $\Phi 0.039[1.00]$
 Top view pad 9.12: $\Phi 0.064[1.63]$
 Bottom view pad 1.2.3.5.6.7.8: $\Phi 0.063[1.60]$
 Bottom view pad 9.12: $\Phi 0.102[2.60]$

THERMAL CONSIDERATIONS

The power module operates in a variety of thermal environments.

However, sufficient cooling should be provided to help ensure reliable operation of the unit.

Heat is removed by conduction, convection, and radiation to the surrounding Environment.

Proper cooling can be verified by measuring the point as the figure below.

The temperature at this location should not exceed "Maximum case temperature".

When Operating, adequate cooling must be provided to maintain the test point temperature at or below "Maximum case temperature".

You can limit this Temperature to a lower value for extremely high reliability.

- Thermal test condition with vertical direction by natural convection (20LFM).

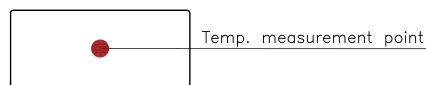

TOP VIEW