

### GENERAL DESCRIPTION

The SGM803, SGM809 and SGM810 are integrated microprocessor supervisory devices. Compared with the design using a single IC or discrete components, this integration design has the advantage of improving system stability and accuracy.

The devices can be reset under power-up, power-down or even voltage reduction brownout conditions. When  $V_{CC}$  is as low as 1V, the reset output can still operate. On the power-on state, the internal timer maintains a 240ms reset assertion that keeps the microprocessor in the reset state until the condition is stable.

The SGM803 has an open-drain  $\overline{\text{RESET}}$  output that needs a resistor pulled up to  $V_{CC}$ . The SGM809 has a push-pull  $\overline{\text{RESET}}$  output. And the SGM810 has a push-pull RESET output. All devices provide eight reset threshold voltage options for 1.8V, 2.5V, 3V, 3.3V and 5V voltage monitoring.

The devices also feature excellent transient immunity to ignore fast  $V_{CC}$  transients. Low quiescent current makes the SGM803, SGM809 and SGM810 very suitable for battery-powered applications.

The SGM803, SGM809 and SGM810 are available in Green SOT-23-3 and SOT-23 packages. They operate over an ambient temperature range of  $-40^{\circ}\text{C}$  to  $+125^{\circ}\text{C}$ .

### FEATURES

- Superior Upgrade for MAX803/MAX809/MAX810 and ADM803/ADM809/ADM810
- High Accuracy Fixed Detection Options: 1.8V, 2.5V, 3V, 3.3V and 5V
- Low Current Consumption: 13 $\mu\text{A}$  (TYP)
- 150ms (MIN) Power-On Reset
- Reset Output Options:
  - Open-Drain  $\overline{\text{RESET}}$  Output: SGM803
  - Push-Pull  $\overline{\text{RESET}}$  Output: SGM809
  - Push-Pull RESET Output: SGM810
- Reset Assertion Down to 1V  $V_{CC}$
- $-40^{\circ}\text{C}$  to  $+125^{\circ}\text{C}$  Operating Temperature Range
- Available in Green SOT-23-3 and SOT-23 Packages

### APPLICATIONS

- Computers
- Battery-Powered Applications
- Portable Equipment
- Automotive Equipment
- Controllers
- Intelligent Instruments
- Critical  $\mu\text{P}$  Power Monitoring

### TYPICAL APPLICATION

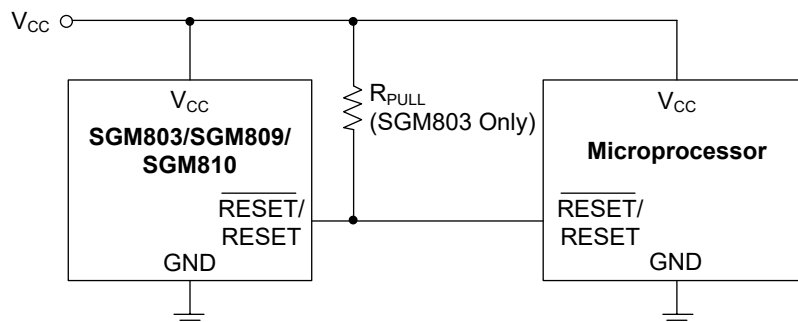

## PACKAGE/ORDERING INFORMATION

MODEL	RESET THRESHOLD (V)	PACKAGE DESCRIPTION	ORDERING NUMBER	PACKAGE MARKING	PACKING OPTION
SGM803	4.63	SOT-23-3	SGM803-LXN3/TR	803L	Tape and Reel, 3000
	4.63	SOT-23	SGM803-LXN3L/TR	803LL	Tape and Reel, 3000
	4.38	SOT-23-3	SGM803-MXN3/TR	803M	Tape and Reel, 3000
	4.38	SOT-23	SGM803-MXN3L/TR	803ML	Tape and Reel, 3000
	4.00	SOT-23-3	SGM803-JXN3/TR	803J	Tape and Reel, 3000
	4.00	SOT-23	SGM803-JXN3L/TR	803JL	Tape and Reel, 3000
	3.08	SOT-23-3	SGM803-TXN3/TR	803T	Tape and Reel, 3000
	3.08	SOT-23	SGM803-TXN3L/TR	803TL	Tape and Reel, 3000
	2.93	SOT-23-3	SGM803-SXN3/TR	803S	Tape and Reel, 3000
	2.93	SOT-23	SGM803-SXN3L/TR	803SL	Tape and Reel, 3000
	2.63	SOT-23-3	SGM803-RXN3/TR	803R	Tape and Reel, 3000
	2.63	SOT-23	SGM803-RXN3L/TR	803RL	Tape and Reel, 3000
	2.32	SOT-23-3	SGM803-ZXN3/TR	803Z	Tape and Reel, 3000
	2.32	SOT-23	SGM803-ZXN3L/TR	803ZL	Tape and Reel, 3000
	1.63	SOT-23-3	SGM803-XXN3/TR	803X	Tape and Reel, 3000
	1.63	SOT-23	SGM803-XXN3L/TR	803XL	Tape and Reel, 3000
SGM809	4.63	SOT-23-3	SGM809-LXN3/TR	809L	Tape and Reel, 3000
	4.63	SOT-23	SGM809-LXN3L/TR	809LL	Tape and Reel, 3000
	4.38	SOT-23-3	SGM809-MXN3/TR	809M	Tape and Reel, 3000
	4.38	SOT-23	SGM809-MXN3L/TR	809ML	Tape and Reel, 3000
	4.00	SOT-23-3	SGM809-JXN3/TR	809J	Tape and Reel, 3000
	4.00	SOT-23	SGM809-JXN3L/TR	809JL	Tape and Reel, 3000
	3.08	SOT-23-3	SGM809-TXN3/TR	809T	Tape and Reel, 3000
	3.08	SOT-23	SGM809-TXN3L/TR	809TL	Tape and Reel, 3000
	2.93	SOT-23-3	SGM809-SXN3/TR	809S	Tape and Reel, 3000
	2.93	SOT-23	SGM809-SXN3L/TR	809SL	Tape and Reel, 3000
	2.63	SOT-23-3	SGM809-RXN3/TR	809R	Tape and Reel, 3000
	2.63	SOT-23	SGM809-RXN3L/TR	809RL	Tape and Reel, 3000
	2.32	SOT-23-3	SGM809-ZXN3/TR	809Z	Tape and Reel, 3000
	2.32	SOT-23	SGM809-ZXN3L/TR	809ZL	Tape and Reel, 3000
	1.63	SOT-23-3	SGM809-XXN3/TR	809X	Tape and Reel, 3000
	1.63	SOT-23	SGM809-XXN3L/TR	809XL	Tape and Reel, 3000

**PACKAGE/ORDERING INFORMATION (continued)**

MODEL	RESET THRESHOLD (V)	PACKAGE DESCRIPTION	ORDERING NUMBER	PACKAGE MARKING	PACKING OPTION
SGM810	4.63	SOT-23-3	SGM810-LXN3/TR	810L	Tape and Reel, 3000
	4.63	SOT-23	SGM810-LXN3L/TR	810LL	Tape and Reel, 3000
	4.38	SOT-23-3	SGM810-MXN3/TR	810M	Tape and Reel, 3000
	4.38	SOT-23	SGM810-MXN3L/TR	810ML	Tape and Reel, 3000
	4.00	SOT-23-3	SGM810-JXN3/TR	810J	Tape and Reel, 3000
	4.00	SOT-23	SGM810-JXN3L/TR	810JL	Tape and Reel, 3000
	3.08	SOT-23-3	SGM810-TXN3/TR	810T	Tape and Reel, 3000
	3.08	SOT-23	SGM810-TXN3L/TR	810TL	Tape and Reel, 3000
	2.93	SOT-23-3	SGM810-SXN3/TR	810S	Tape and Reel, 3000
	2.93	SOT-23	SGM810-SXN3L/TR	810SL	Tape and Reel, 3000
	2.63	SOT-23-3	SGM810-RXN3/TR	810R	Tape and Reel, 3000
	2.63	SOT-23	SGM810-RXN3L/TR	810RL	Tape and Reel, 3000
	2.32	SOT-23-3	SGM810-ZXN3/TR	810Z	Tape and Reel, 3000
	2.32	SOT-23	SGM810-ZXN3L/TR	810ZL	Tape and Reel, 3000
	1.63	SOT-23-3	SGM810-XXN3/TR	810X	Tape and Reel, 3000
	1.63	SOT-23	SGM810-XXN3L/TR	810XL	Tape and Reel, 3000

Green (RoHS & HSF): SG Micro Corp defines "Green" to mean Pb-Free (RoHS compatible) and free of halogen substances. If you have additional comments or questions, please contact your SGMICRO representative directly.

**ABSOLUTE MAXIMUM RATINGS**

(Typical values are at T<sub>A</sub> = +25°C, unless otherwise noted.)  
V<sub>CC</sub>..... -0.3V to 6V  
RESET,  $\overline{\text{RESET}}$ .....-0.3V to V<sub>CC</sub> + 0.3V  
Input Current, V<sub>CC</sub>..... 20mA  
Output Current, RESET,  $\overline{\text{RESET}}$  ..... 20mA  
Rate of Rise, V<sub>CC</sub>..... 100V/μs  
Power Dissipation, P<sub>D</sub> @ T<sub>A</sub> = +25°C  
SOT-23-3 ..... 0.4W  
Package Thermal Resistance  
SOT-23-3, θ<sub>JA</sub> ..... 250°C/W  
Junction Temperature ..... +150°C  
Storage Temperature Range .....-65°C to +150°C  
Lead Temperature (Soldering, 10s).....+260°C  
ESD Susceptibility  
HBM..... 4000V  
MM..... 400V

**RECOMMENDED OPERATING CONDITIONS**

Operating Temperature Range .....-40°C to +125°C

**OVERSTRESS CAUTION**

Stresses beyond those listed in Absolute Maximum Ratings may cause permanent damage to the device. Exposure to absolute maximum rating conditions for extended periods may affect reliability. Functional operation of the device at any conditions beyond those indicated in the Recommended Operating Conditions section is not implied.

**ESD SENSITIVITY CAUTION**

This integrated circuit can be damaged by ESD if you don't pay attention to ESD protection. SGMICRO recommends that all integrated circuits be handled with appropriate precautions. Failure to observe proper handling and installation procedures can cause damage. ESD damage can range from subtle performance degradation to complete device failure. Precision integrated circuits may be more susceptible to damage because very small parametric changes could cause the device not to meet its published specifications.

**DISCLAIMER**

SG Micro Corp reserves the right to make any change in circuit design, or specifications without prior notice.

PIN CONFIGURATIONS

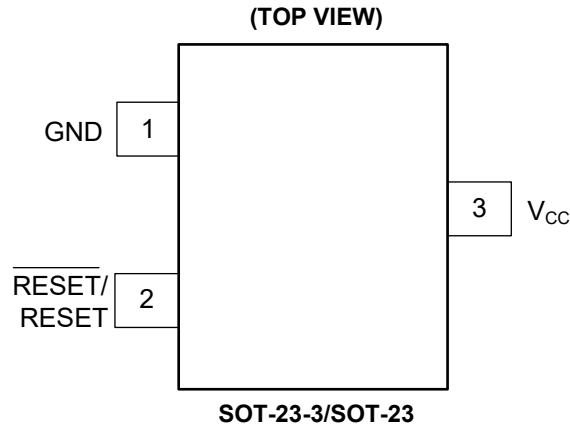

PIN DESCRIPTION

NAME	PIN NUMBER			FUNCTION
	SGM803	SGM809	SGM810	
GND	1	1	1	Ground Pin.
$\overline{\text{RESET}}$	2	2	—	Active-Low Reset Output (SGM803/SGM809). If V <sub>CC</sub> is lower than the reset threshold, the $\overline{\text{RESET}}$ goes low. If V <sub>CC</sub> voltage is higher than the reset threshold, the reset output remains low within a timeout period (240ms, TYP)
RESET	—	—	2	Active-High Reset Output Pin (SGM810). It is the inverse of $\overline{\text{RESET}}$ .
V <sub>CC</sub>	3	3	3	Supply Voltage Pin.

**ELECTRICAL CHARACTERISTICS**(V<sub>CC</sub> = 5V for L/M/J Models, 3.3V for T/S Models, 3V for R Models, 2.5V for Z Model, 1.8V for X Model, unless otherwise noted.)

PARAMETER	CONDITIONS	MIN	TYP	MAX	UNITS
<b>SUPPLY</b>					
Voltage	T <sub>A</sub> = 0°C to +70°C	1.0		5.5	V
	T <sub>A</sub> = -40°C to +125°C	1.2		5.5	V
Current	V <sub>CC</sub> < 5.5V, SGM8_L/M/J, T <sub>A</sub> = +25°C		17	30	μA
	V <sub>CC</sub> < 5.5V, SGM8_L/M/J, T <sub>A</sub> = -40°C to +125°C			50	μA
	V <sub>CC</sub> < 3.6V, SGM8_R/S/T/Z/X, T <sub>A</sub> = +25°C		13	25	μA
	V <sub>CC</sub> < 3.6V, SGM8_R/S/T/Z/X, T <sub>A</sub> = -40°C to +125°C			45	μA
<b>RESET VOLTAGE THRESHOLD</b>					
SGM8_L	T <sub>A</sub> = +25°C	4.537	4.63	4.723	V
	T <sub>A</sub> = -40°C to +125°C	4.40		4.86	V
SGM8_M	T <sub>A</sub> = +25°C	4.292	4.38	4.468	V
	T <sub>A</sub> = -40°C to +125°C	4.16		4.56	V
SGM8_J	T <sub>A</sub> = +25°C	3.92	4.00	4.08	V
	T <sub>A</sub> = -40°C to +125°C	3.8		4.2	V
SGM8_T	T <sub>A</sub> = +25°C	3.003	3.08	3.157	V
	T <sub>A</sub> = -40°C to +125°C	2.92		3.23	V
SGM8_S	T <sub>A</sub> = +25°C	2.857	2.93	3.003	V
	T <sub>A</sub> = -40°C to +125°C	2.78		3.08	V
SGM8_R	T <sub>A</sub> = +25°C	2.564	2.63	2.696	V
	T <sub>A</sub> = -40°C to +125°C	2.50		2.76	V
SGM8_Z	T <sub>A</sub> = +25°C	2.262	2.32	2.378	V
	T <sub>A</sub> = -40°C to +125°C	2.22		2.42	V
SGM8_X	T <sub>A</sub> = +25°C	1.589	1.63	1.671	V
	T <sub>A</sub> = -40°C to +125°C	1.55		1.71	V
Reset Threshold Temperature Coefficient			30		ppm/°C
V <sub>CC</sub> to RESET/RESET Delay	V <sub>CC</sub> = V <sub>TH</sub> to (V <sub>TH</sub> - 100mV)		20		μs
Reset Active Timeout Period	T <sub>A</sub> = -40°C to +85°C	150	240	560	ms
	T <sub>A</sub> = -40°C to +125°C	100		840	ms
<b>RESET/RESET OUTPUT VOLTAGE</b>					
Low (SGM803R/S/T/Z/X) Low (SGM809R/S/T/Z/X)	V <sub>CC</sub> = V <sub>TH(MIN)</sub> , I <sub>SINK</sub> = 1.2mA			0.3	V
Low (SGM803L/M/J) Low (SGM809L/M/J)	V <sub>CC</sub> = V <sub>TH(MIN)</sub> , I <sub>SINK</sub> = 3.2mA			0.4	V
Low (SGM803R/S/T/L/M/J/Z/X) Low (SGM809R/S/T/L/M/J/Z/X)	V <sub>CC</sub> > 1.0V, I <sub>SINK</sub> = 50μA			0.3	V
High (SGM809R/S/T/Z/X)	V <sub>CC</sub> > V <sub>TH(MAX)</sub> , I <sub>SOURCE</sub> = 500μA	0.8 × V <sub>CC</sub>			V
High (SGM809L/M/J)	V <sub>CC</sub> > V <sub>TH(MAX)</sub> , I <sub>SOURCE</sub> = 800μA	V <sub>CC</sub> - 1.5			V
Low (SGM810R/S/T/Z/X)	V <sub>CC</sub> = V <sub>TH(MAX)</sub> , I <sub>SINK</sub> = 1.2mA			0.3	V
Low (SGM810L/M/J)	V <sub>CC</sub> = V <sub>TH(MAX)</sub> , I <sub>SINK</sub> = 3.2mA			0.4	V
High (SGM810R/S/T/L/M/J/Z)	1.8V < V <sub>CC</sub> < V <sub>TH(MIN)</sub> , I <sub>SOURCE</sub> = 150μA	0.8 × V <sub>CC</sub>			V
High (SGM810X)	1.2V < V <sub>CC</sub> < V <sub>TH(MIN)</sub> , I <sub>SOURCE</sub> = 150μA	0.8 × V <sub>CC</sub>			V
RESET Open-Drain Output Leakage Current (SGM803)	V <sub>CC</sub> > V <sub>TH</sub> , reset de-asserted			1	μA

TYPICAL PERFORMANCE CHARACTERISTICS

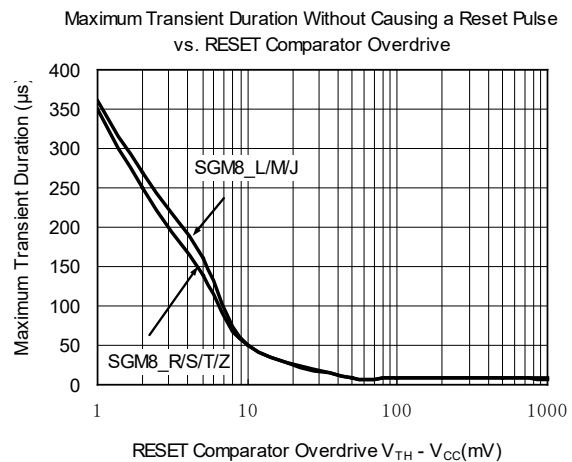
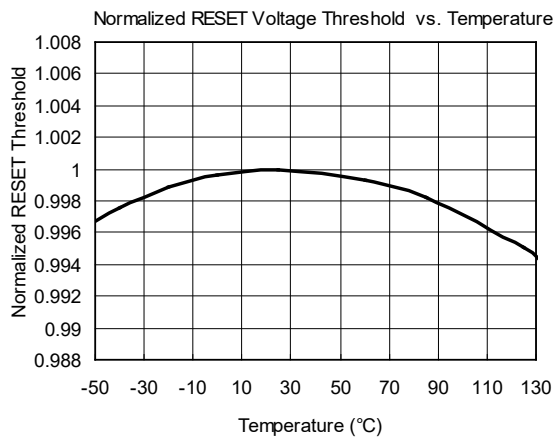
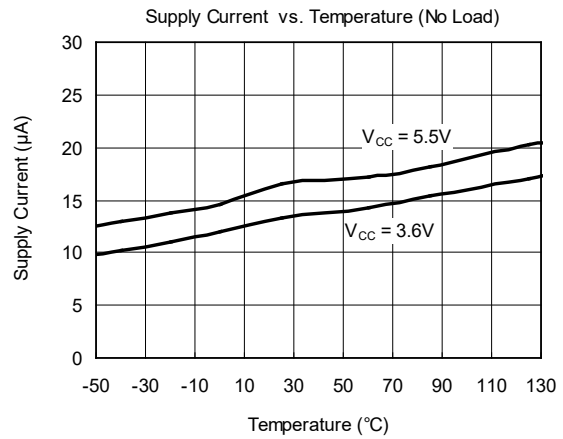
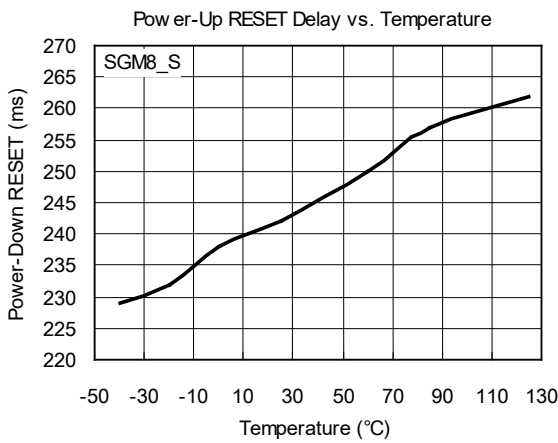
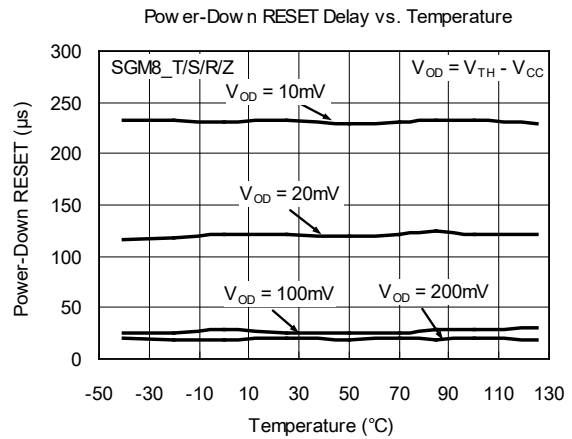
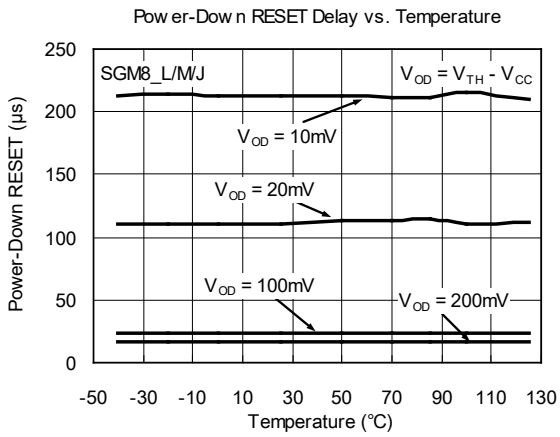

TYPICAL PERFORMANCE CHARACTERISTICS (continued)

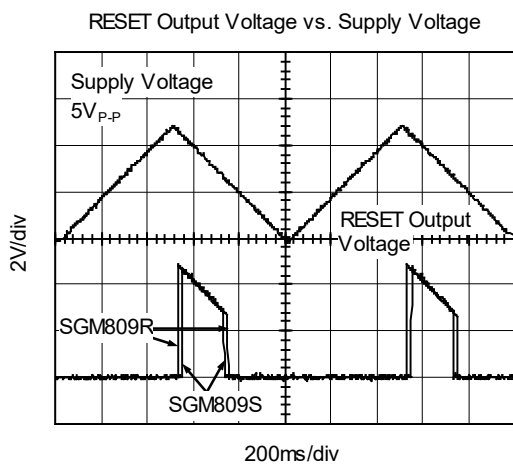

**REVISION HISTORY**

NOTE: Page numbers for previous revisions may differ from page numbers in the current version.

**JANUARY 2018 – REV.E.2 to REV.E.3**

---

Changed Reset Timing Diagram.....9

---

**SEPTEMBER 2015 – REV.E.1 to REV.E.2**

---

Changed Electrical Characteristics section ..... 5

---

**JANUARY 2013 – REV.E to REV.E.1**

---

Added Recommended Land Pattern Information ..... 10, 11

Added Tape and Reel Information..... 12, 13

---



PACKAGE OUTLINE DIMENSIONS

SOT-23

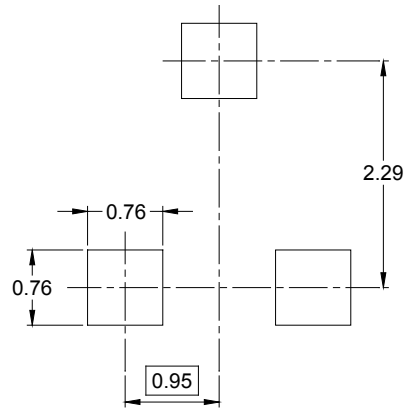
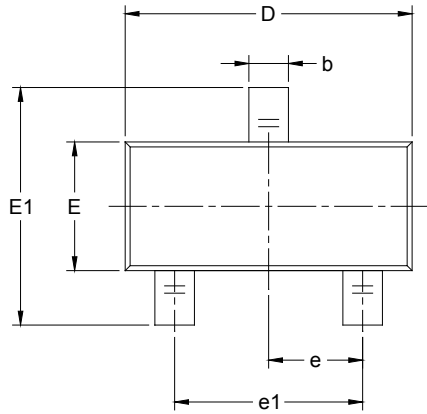

RECOMMENDED LAND PATTERN (Unit: mm)

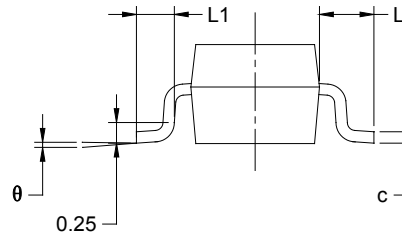
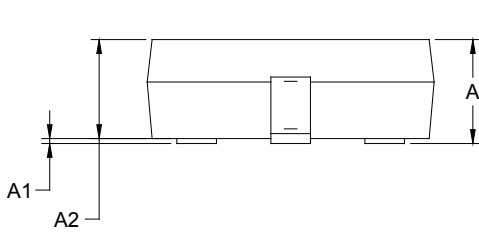

Symbol	Dimensions In Millimeters		Dimensions In Inches	
	MIN	MAX	MIN	MAX
A	0.900	1.150	0.035	0.045
A1	0.000	0.100	0.000	0.004
A2	0.900	1.050	0.035	0.041
b	0.300	0.500	0.012	0.020
c	0.080	0.150	0.003	0.006
D	2.800	3.000	0.110	0.118
E	1.200	1.400	0.047	0.055
E1	2.250	2.550	0.089	0.100
e	0.950 BSC		0.037 BSC	
e1	1.900 BSC		0.075 BSC	
L	0.550 REF		0.022 REF	
L1	0.300	0.500	0.012	0.020
$\theta$	0°	8°	0°	8°

PACKAGE OUTLINE DIMENSIONS

SOT-23-3

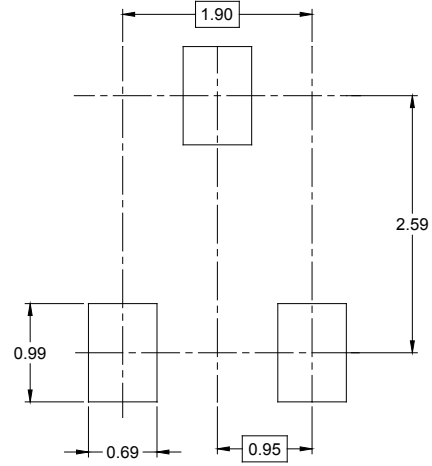
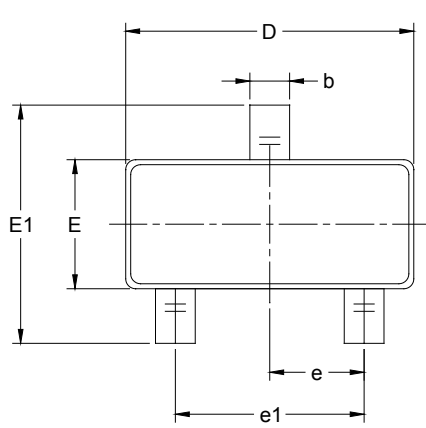

RECOMMENDED LAND PATTERN (Unit: mm)

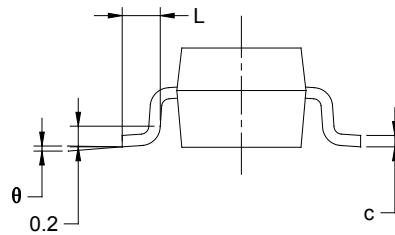
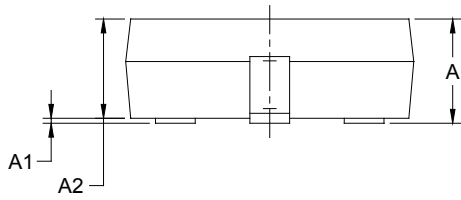

Symbol	Dimensions In Millimeters		Dimensions In Inches	
	MIN	MAX	MIN	MAX
A	1.050	1.250	0.041	0.049
A1	0.000	0.100	0.000	0.004
A2	1.050	1.150	0.041	0.045
b	0.300	0.500	0.012	0.020
c	0.100	0.200	0.004	0.008
D	2.820	3.020	0.111	0.119
E	1.500	1.700	0.059	0.067
E1	2.650	2.950	0.104	0.116
e	0.950 BSC		0.037 BSC	
e1	1.900 BSC		0.075 BSC	
L	0.300	0.600	0.012	0.024
$\theta$	0°	8°	0°	8°

## TAPE AND REEL INFORMATION

### REEL DIMENSIONS



### TAPE DIMENSIONS



NOTE: The picture is only for reference. Please make the object as the standard.

### KEY PARAMETER LIST OF TAPE AND REEL

Package Type	Reel Diameter	Reel Width W1 (mm)	A0 (mm)	B0 (mm)	K0 (mm)	P0 (mm)	P1 (mm)	P2 (mm)	W (mm)	Pin1 Quadrant
SOT-23	7"	9.5	3.15	2.77	1.22	4.0	4.0	2.0	8.0	Q3
SOT-23-3	7"	9.0	3.20	3.30	1.30	4.0	4.0	2.0	8.0	Q3

DD0001

# PACKAGE INFORMATION

## CARTON BOX DIMENSIONS



NOTE: The picture is only for reference. Please make the object as the standard.

## KEY PARAMETER LIST OF CARTON BOX

Reel Type	Length (mm)	Width (mm)	Height (mm)	Pizza/Carton
7" (Option)	368	227	224	8
7"	442	410	224	18

DD0002