



SGM8557-1/SGM8557-2 SGM8557-3/SGM8557-5

15MHz, High Output Drive, High Precision, Low Noise Operational Amplifiers

GENERAL DESCRIPTION

The SGM8557-1 (single), SGM8557-3 (single with shutdown), SGM8557-2 (dual) and SGM8557-5 (dual with shutdown) are low noise, high precision CMOS operational amplifiers that provide a high output current of 240mA, rail-to-rail output operation from a range of 2.7V to 5.5V single supply. The SGM8557-1/2/3/5 offer low input offset voltage, low input offset voltage drift, wide bandwidth and high output current drive. These devices also can achieve a high 15MHz gain-bandwidth product and a high 7V/ μ s slew rate. The SGM8557-3/5 are both available with shutdown pins that drive the output voltage low.

The SGM8557-1 is available in Green SOIC-8, MSOP-8 and SOT-23-5 packages. The SGM8557-2 is available in a Green SOIC-8 package. The SGM8557-3 is available in Green SOIC-8 and SOT-23-6 packages. The SGM8557-5 is available in a Green MSOP-10 package. They operate over an ambient temperature range of -40°C to +125°C.

APPLICATIONS

Battery-Powered Audio Equipment
Audio Output Portable Systems
Hands-Free Mobile Phones (Kits)
Mobile communication Equipment
Wireless Handset Applications
DAC Buffers
Powered Speaker Systems
Transformer/Line Drivers

FEATURES

- 240mA High Output Drive Capability
- Low Input Offset Voltage: 5 μ V (MAX)
- Low Input Offset Voltage Drift: 27nV/°C (TYP)
- Low Noise: 30nV/ $\sqrt{\text{Hz}}$ at 1kHz
- Over-Temperature Protection
- Gain-Bandwidth Product: 15MHz
- High Slew Rate: 7V/ μ s
- High Open-Loop Gain ($R_L = 2\text{k}\Omega$): 144dB
- Power Supply Rejection Ratio: 120dB
- No Phase Reversal for Overdriven Inputs
- Rail-to-Rail Output
- Supply Voltage Range: 2.7V to 5.5V
- Quiescent Supply Current:
 - 1.2mA/Amplifier (TYP)
 - 0.3 μ A/Amplifier (TYP) Shutdown Current for SGM8557-3/5
- Small Packaging:
 - SGM8557-1 Available in Green SOIC-8, MSOP-8, and SOT-23-5 Packages
 - SGM8557-2 Available in a Green SOIC-8 Package
 - SGM8557-3 Available in Green SOIC-8 and SOT-23-6 Packages
 - SGM8557-5 Available in a Green MSOP-10 Package

PACKAGE/ORDERING INFORMATION

MODEL	PACKAGE DESCRIPTION	SPECIFIED TEMPERATURE RANGE	ORDERING NUMBER	PACKAGE MARKING	PACKING OPTION
SGM8557-1	SOIC-8	-40°C to +125°C	SGM8557-1XS8G/TR	SGM 85571XS8 XXXXX	Tape and Reel, 2500
	MSOP-8	-40°C to +125°C	SGM8557-1XMS8G/TR	SGM85571 XMS8 XXXXX	Tape and Reel, 4000
	SOT-23-5	-40°C to +125°C	SGM8557-1AXN5G/TR	GG8XX	Tape and Reel, 3000
	SOT-23-5	-40°C to +125°C	SGM8557-1BXN5G/TR	GCEXX	Tape and Reel, 3000
SGM8557-2	SOIC-8	-40°C to +125°C	SGM8557-2XS8G/TR	SGM 85572XS8 XXXXX	Tape and Reel, 2500
SGM8557-3	SOIC-8	-40°C to +125°C	SGM8557-3XS8G/TR	SGM 85573XS8 XXXXX	Tape and Reel, 2500
	SOT-23-6	-40°C to +125°C	SGM8557-3XN6G/TR	GCFXX	Tape and Reel, 3000
SGM8557-5	MSOP-10	-40°C to +125°C	SGM8557-5XMS10G/TR	SGM85575 XMS10 XXXXX	Tape and Reel, 4000

MARKING INFORMATION

SOT-23-5/SOT-23-6

(1) XX = Date Code.

YYY X X

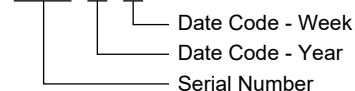

SGM8557-2: SOIC-8

(3) XXXXX = Trace Code and Vendor Code.

XXXXX

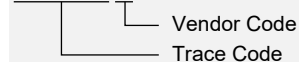

SOIC-8/MSOP-8

(2) XXXXX = Date Code and Vendor Code.

XXXXX

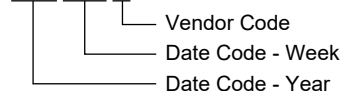

SGM8557-5: MSOP-10

(4) XXXXX = Trace Code and Vendor Code.

XXXXX

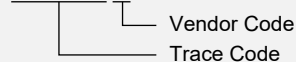

Green (RoHS & HSF): SG Micro Corp defines "Green" to mean Pb-Free (RoHS compatible) and free of halogen substances. If you have additional comments or questions, please contact your SGMICRO representative directly.

ABSOLUTE MAXIMUM RATINGS

Supply Voltage, +V _s to -V _s	6V
All Other Pins.....	(-V _s) - 0.3V to (+V _s) + 0.3V
Junction Temperature.....	+150°C
Storage Temperature Range.....	-65°C to +150°C
Lead Temperature (Soldering, 10s).....	+260°C
ESD Susceptibility	
HBM.....	7000V
MM.....	400V
CDM.....	1000V

RECOMMENDED OPERATING CONDITIONS

Operating Temperature Range.....	-40°C to +125°C
Operating Supply Voltage Range.....	2.7V to 5.5V

OVERSTRESS CAUTION

Stresses beyond those listed in Absolute Maximum Ratings may cause permanent damage to the device. Exposure to absolute maximum rating conditions for extended periods may affect reliability. Functional operation of the device at any conditions beyond those indicated in the Recommended Operating Conditions section is not implied.

ESD SENSITIVITY CAUTION

This integrated circuit can be damaged if ESD protections are not considered carefully. SGMICRO recommends that all integrated circuits be handled with appropriate precautions. Failure to observe proper handling and installation procedures can cause damage. ESD damage can range from subtle performance degradation to complete device failure. Precision integrated circuits may be more susceptible to damage because even small parametric changes could cause the device not to meet the published specifications.

DISCLAIMER

SG Micro Corp reserves the right to make any change in circuit design, or specifications without prior notice.

PIN CONFIGURATIONS

SGM8557-1 (TOP VIEW)

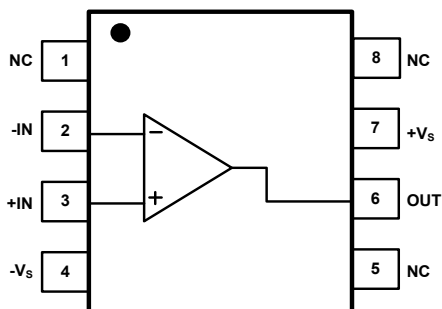

SOIC-8/MSOP-8

SGM8557-1AXN5G (TOP VIEW)

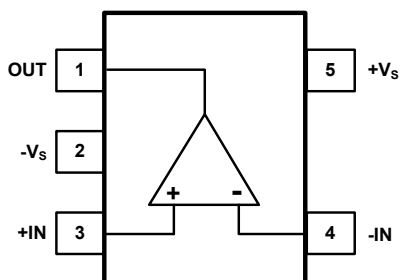

SOT-23-5

SGM8557-1BXN5G (TOP VIEW)

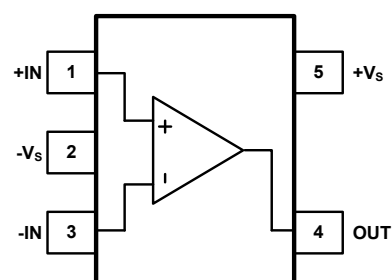

SOT-23-5

SGM8557-3 (TOP VIEW)

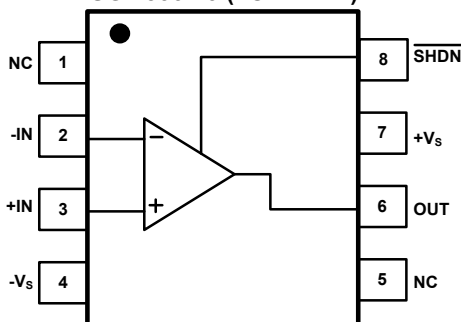

SOIC-8

SGM8557-3 (TOP VIEW)

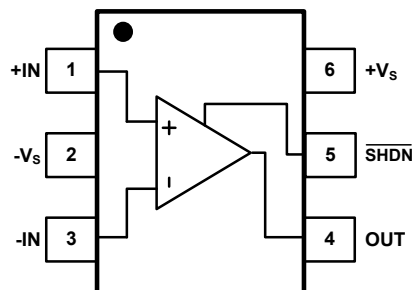

SOT-23-6

SGM8557-2 (TOP VIEW)

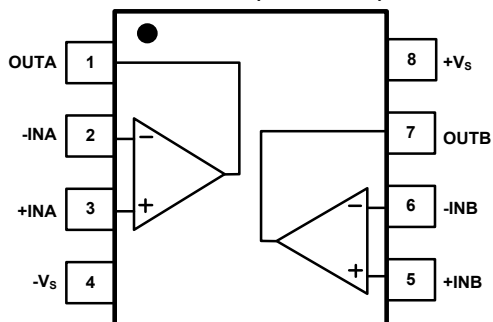

SOIC-8

SGM8557-5 (TOP VIEW)

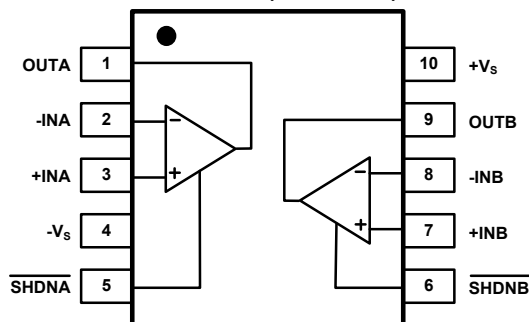

MSOP-10

ELECTRICAL CHARACTERISTICS

($V_S = 2.7V$ to $5V$, $-V_S = 0V$, $V_{CM} = V_S/2$, $V_{OUT} = V_S/2$, R_L connected to $V_S/2$, $V_{SHDN} = V_S$, Full = $-40^\circ C$ to $+125^\circ C$, typical values are at $T_A = +25^\circ C$, unless otherwise noted.)

PARAMETER	SYMBOL	CONDITIONS	TEMP	MIN	TYP	MAX	UNITS	
Input Characteristics								
Input Offset Voltage	V_{OS}	$V_S = 2.7V$	+25°C		2.4	5	μV	
		$V_S = 5V$	+25°C		2.8	5		
Input Offset Voltage Drift	$\Delta V_{OS}/\Delta T$	$V_S = 2.7V$	Full		27	126	nV/°C	
		$V_S = 5V$	Full		27	130		
Input Bias Current	I_B	$V_S = 5V$	+25°C		240		pA	
Input Offset Current	I_{OS}	$V_S = 5V$	+25°C		480		pA	
Input Common Mode Voltage Range	V_{CM}	Inferred from CMRR test	Full	$(-V_S) - 0.1$		$(+V_S) + 0.1$	V	
Common Mode Rejection Ratio	CMRR	$V_S = 2.7V$, $(-V_S) - 0.1V < V_{CM} < (+V_S) + 0.1V$	+25°C	106	120		dB	
			Full	102				
		$V_S = 5V$, $(-V_S) - 0.1V < V_{CM} < (+V_S) + 0.1V$	+25°C	106	120			
			Full	90				
Open-Loop Voltage Gain	A_{OL}	$V_S = 2.7V$, $(-V_S) + 0.2V < V_{OUT} < (+V_S) - 0.2V$	$R_L = 2k\Omega$	+25°C	112	135	dB	
			$R_L = 200\Omega$	+25°C	110	136		
			$R_L = 2k\Omega$	Full	109			
			$R_L = 200\Omega$	Full	107			
		$V_S = 5V$, $(-V_S) + 0.2V < V_{OUT} < (+V_S) - 0.2V$	$R_L = 2k\Omega$	+25°C	117	144		
			$R_L = 200\Omega$	+25°C	110	142		
			$R_L = 2k\Omega$	Full	114			
			$R_L = 200\Omega$	Full	107			
Output Characteristics								
Output Voltage Swing from Rail	V_{OUT}	$V_S = 2.7V$	$R_L = 32\Omega$	+25°C		240	300	mV
				Full			370	
			$R_L = 200\Omega$	+25°C		45	60	
				Full			72	
			$R_L = 2k\Omega$	+25°C		5	10	
				Full			11	
			$I_{OUT} = 10mA$	+25°C		60	95	
				Full			115	
		$V_S = 5V$	$R_L = 32\Omega$	+25°C		390	485	
				Full			580	
			$R_L = 200\Omega$	+25°C		72	90	
				Full			110	
			$R_L = 2k\Omega$	+25°C		8	15	
				Full			18	
			$I_{OUT} = 10mA$	+25°C		60	82	
				Full			98	
Short-Circuit Current Limit	I_{SC}	$V_S = 2.7V$	+25°C	92	120		mA	
			Full	64				
		$V_S = 5V$	+25°C	182	240			
			Full	148				

ELECTRICAL CHARACTERISTICS (continued)

($V_S = 2.7V$ to $5V$, $-V_S = 0V$, $V_{CM} = V_S/2$, $V_{OUT} = V_S/2$, R_L connected to $V_S/2$, $V_{\overline{SHDN}} = V_S$, Full = $-40^\circ C$ to $+125^\circ C$, typical values are at $T_A = +25^\circ C$, unless otherwise noted.)

PARAMETER	SYMBOL	CONDITIONS	TEMP	MIN	TYP	MAX	UNITS
Power-Down Disable (SGM8557-3/5 Only)							
Shutdown Supply Current/Amplifier	$I_{Q(SHDN)}$	$V_{\overline{SHDN}} = 0V$, $R_L = \infty$, $V_S = 5V$	$+25^\circ C$		0.3	2	μA
\overline{SHDN} Logic Threshold	V_{IL}	Shutdown mode	$+25^\circ C$			0.8	V
	V_{IH}	Normal mode	$+25^\circ C$	$(+V_S) \times 0.57$			
\overline{SHDN} Input Bias Current		$-V_S < V_{\overline{SHDN}} < V_S$	$+25^\circ C$		50		μA
Shutdown Output Impedance	R_{OUT}	$V_{\overline{SHDN}} = 0V$	$+25^\circ C$		10		Ω
Output Voltage in Shutdown	$V_{OUT(SHDN)}$	$V_{\overline{SHDN}} = 0V$, $R_L = 200\Omega$	$+25^\circ C$		70		mV
Power Supply							
Supply Voltage Range	V_S	Inferred from PSRR test	Full	2.7		5.5	V
Power Supply Rejection Ratio	PSRR		$+25^\circ C$	102	120		dB
			Full	94			
Quiescent Supply Current/Amplifier	I_Q	$V_S = 2.7V$	$+25^\circ C$		1.15	1.62	mA
			$+25^\circ C$		1.15	1.65	
			Full			2.15	
Quiescent Supply Current/Amplifier	I_Q	$V_S = 5V$	$+25^\circ C$		1.15	1.65	mA
			$+25^\circ C$		1.15	1.65	
			Full			2.15	
Dynamic Performance							
Gain-Bandwidth Product	GBP		$+25^\circ C$		15		MHz
Slew Rate	SR		$+25^\circ C$		7		$V/\mu s$
Total Harmonic Distortion + Noise	THD+N	$V_S = 5V$, $R_L = 32\Omega$, $f = 10kHz$, BW = 10Hz to 90kHz, $V_{OUT} = 2V_{P-P}$, $A_{VCL} = 1V/V$	$+25^\circ C$		0.017		%
Input Capacitance	C_{IN}		$+25^\circ C$		20		pF
Channel-to-Channel Isolation		$f = 1kHz$, $R_L = 100k\Omega$	$+25^\circ C$		-125		dB
Capacitive-Load Stability		$A_{VCL} = 1V/V$, no sustained oscillations	$+25^\circ C$		780		pF
Noise							
Input Voltage Noise		$f = 0.1Hz$ to $10Hz$	$+25^\circ C$		0.5		μV_{P-P}
Input Voltage Noise Density	e_n	$f = 1kHz$	$+25^\circ C$		30		nV/\sqrt{Hz}
		$f = 10kHz$	$+25^\circ C$		28		

TYPICAL PERFORMANCE CHARACTERISTICS

At $T_A = +25^\circ\text{C}$, $V_S = 5\text{V}$, unless otherwise noted.

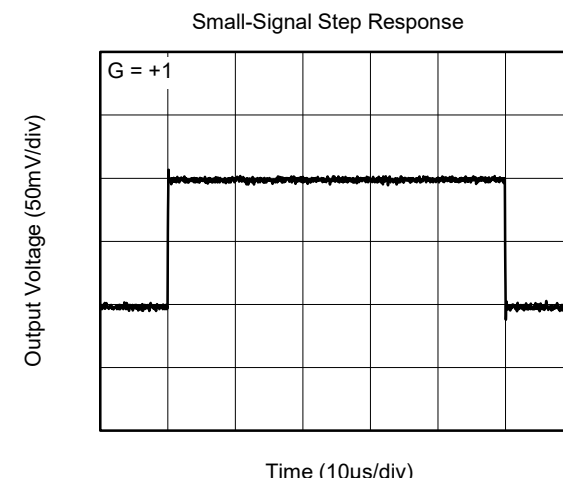
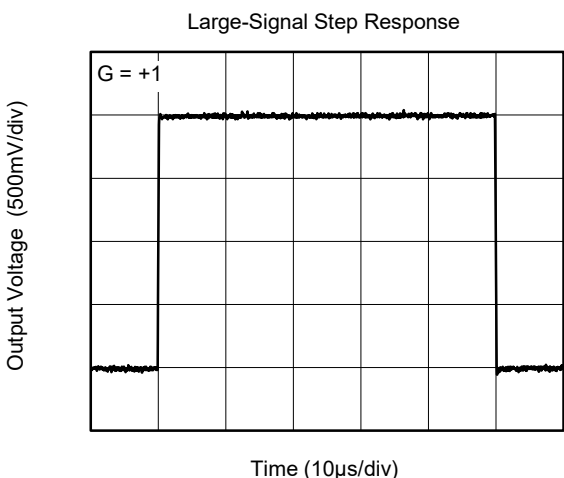
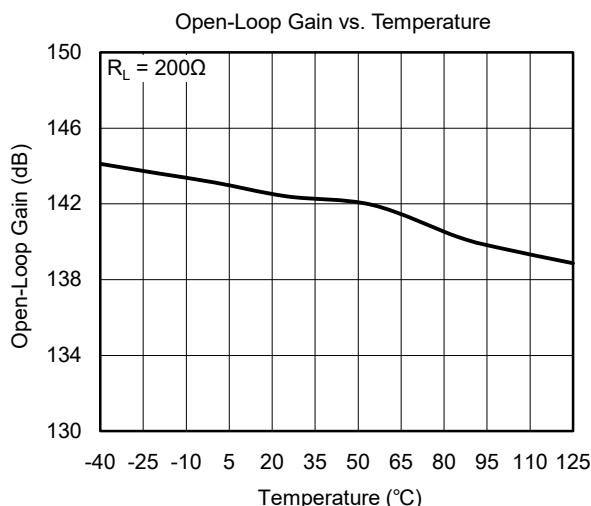
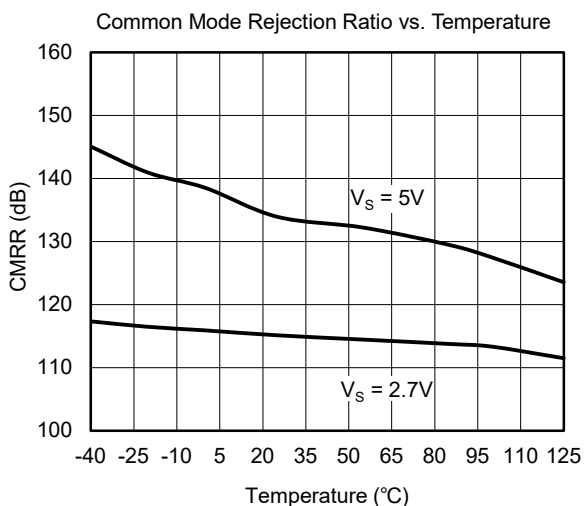
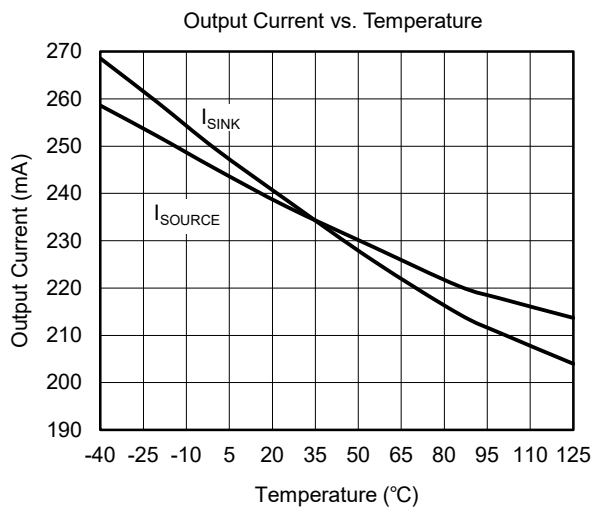
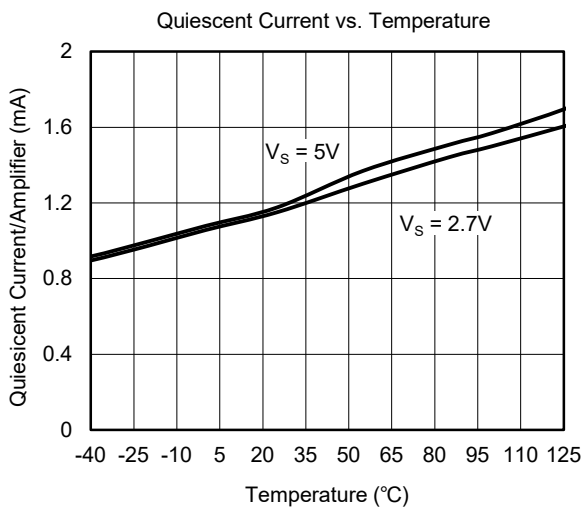

TYPICAL PERFORMANCE CHARACTERISTICS (continued)

At $T_A = +25^\circ\text{C}$, $V_S = 5\text{V}$, unless otherwise noted.

0.1Hz to 10Hz Noise

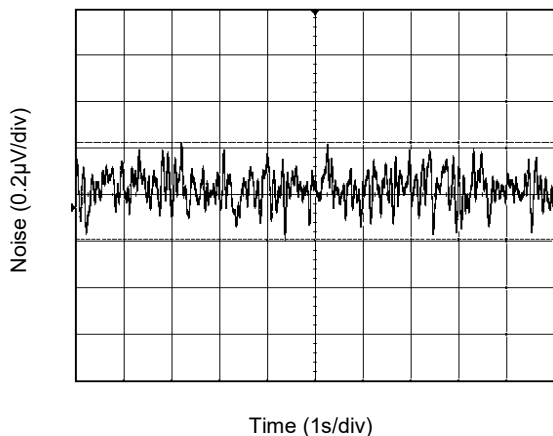

Input Voltage Noise Density vs. Frequency

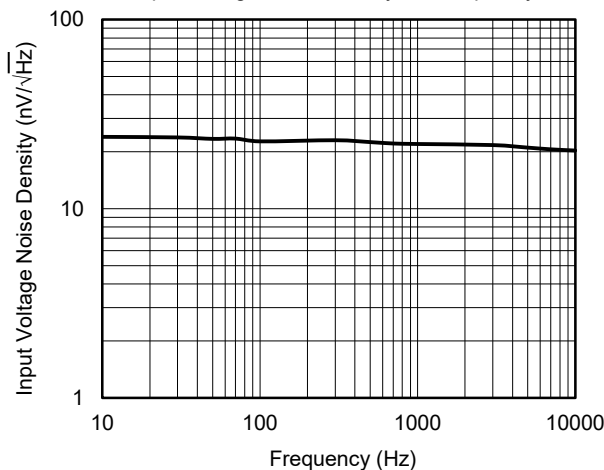

Common Mode Rejection Ratio vs. Frequency

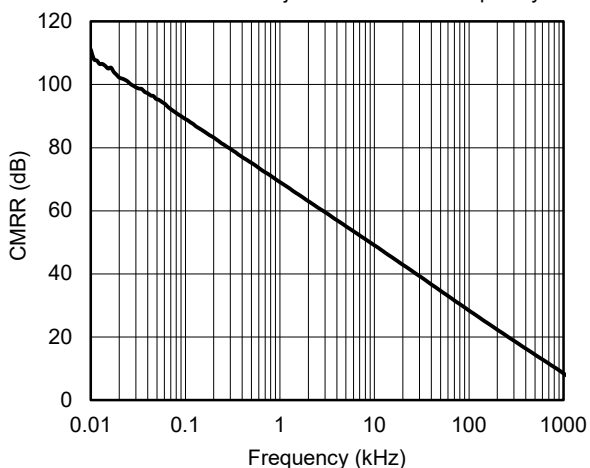

Power Supply Rejection Ratio vs. Frequency

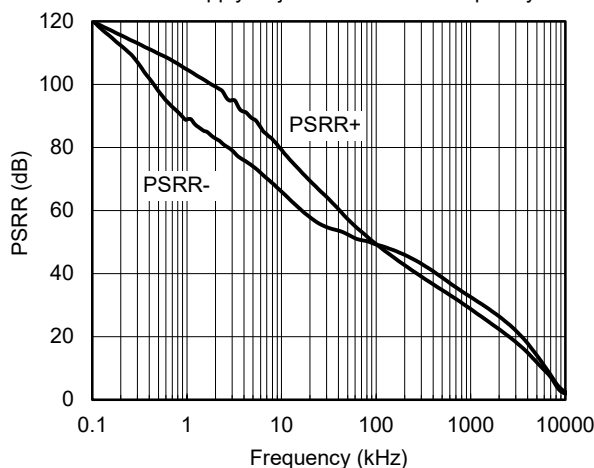

THD+N vs. Output Voltage

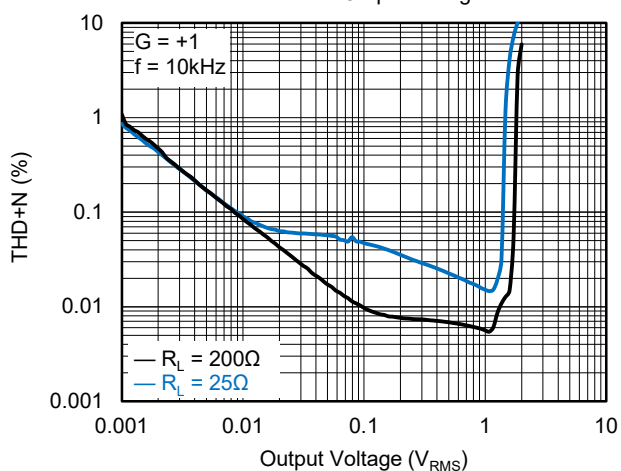

THD+N vs. Output Voltage

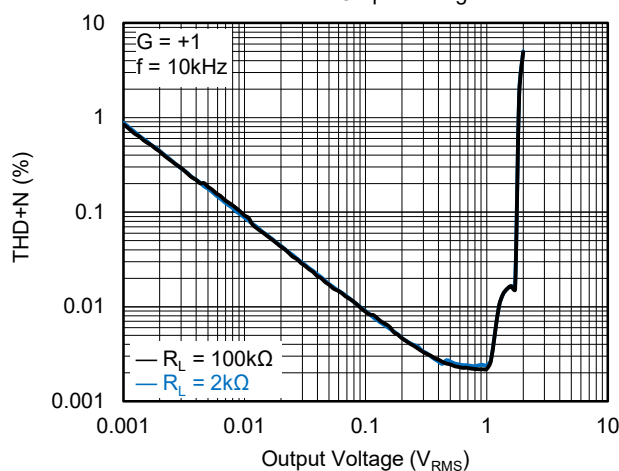

TYPICAL PERFORMANCE CHARACTERISTICS (continued)

At $T_A = +25^\circ\text{C}$, $V_S = 5\text{V}$, unless otherwise noted.

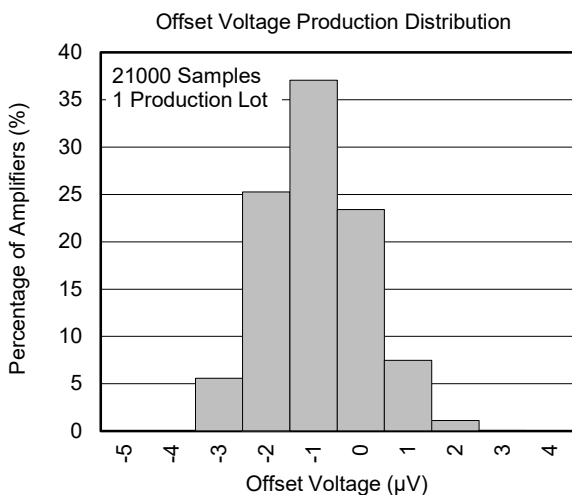
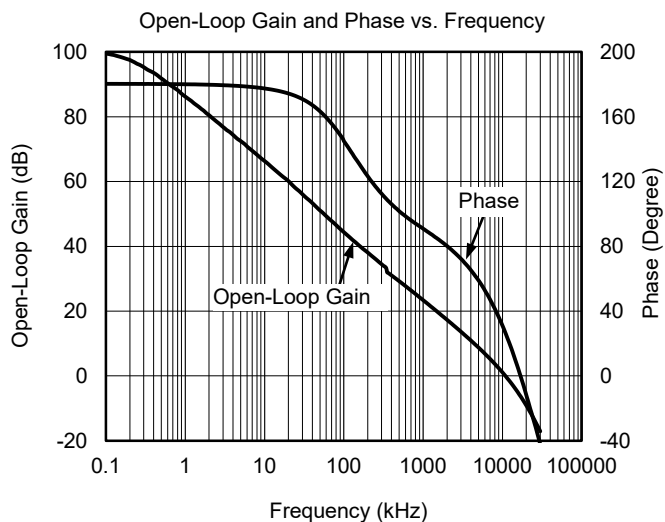
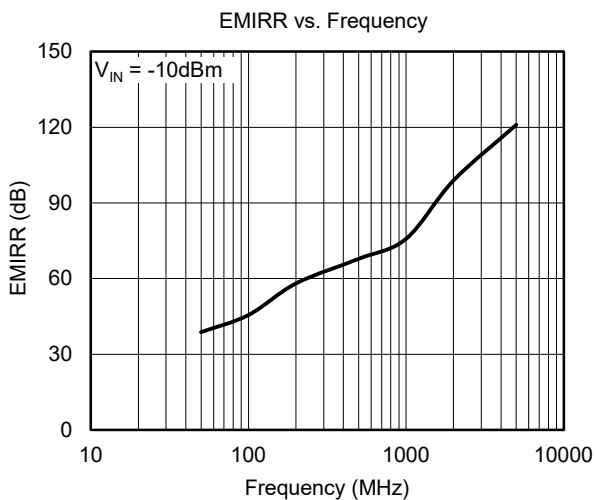

REVISION HISTORY

NOTE: Page numbers for previous revisions may differ from page numbers in the current version.

SEPTEMBER 2021 – REV.A.4 to REV.B	Page
Updated Marking Information section.....	2
Updated Absolute Maximum Ratings section.....	3
Updated Electrical Characteristics section.....	5, 6
Updated Typical Performance Characteristics section.....	7 ~ 9
Updated Application Information section.....	10

OCTOBER 2019 – REV.A.3 to REV.A.4	Page
Updated Marking Information section.....	2

JANUARY 2019 – REV.A.2 to REV.A.3	Page
Changed Figure 2.....	9

DECEMBER 2017 – REV.A.1 to REV.A.2	Page
Added Typical Performance Characteristics.....	8

NOVEMBER 2017 – REV.A to REV.A.1	Page
Changed Electrical Characteristics section.....	4
Changed Typical Performance Characteristics section.....	7, 8

Changes from Original (DECEMBER 2016) to REV.A	Page
Changed from product preview to production data.....	All

PACKAGE OUTLINE DIMENSIONS

SOT-23-5

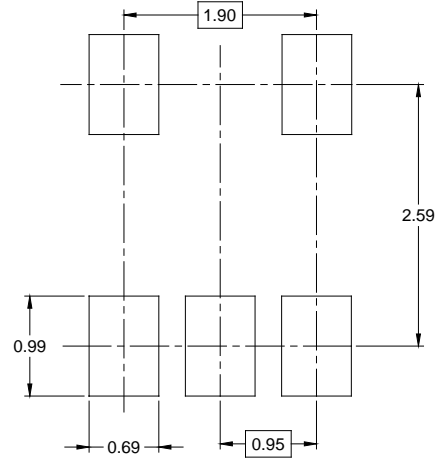
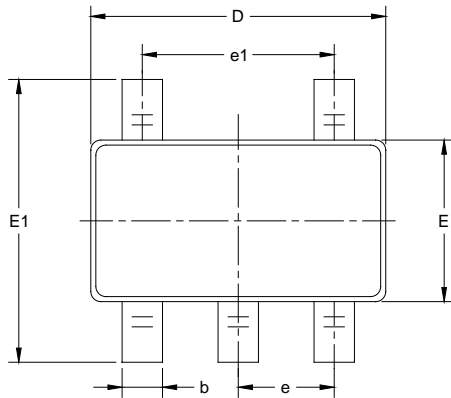

RECOMMENDED LAND PATTERN (Unit: mm)

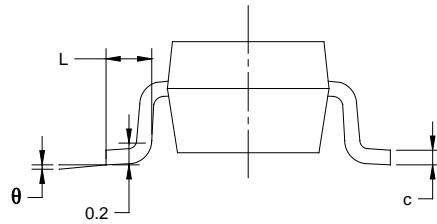
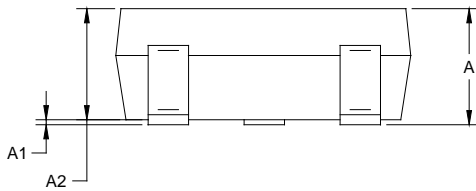

Symbol	Dimensions In Millimeters		Dimensions In Inches	
	MIN	MAX	MIN	MAX
A	1.050	1.250	0.041	0.049
A1	0.000	0.100	0.000	0.004
A2	1.050	1.150	0.041	0.045
b	0.300	0.500	0.012	0.020
c	0.100	0.200	0.004	0.008
D	2.820	3.020	0.111	0.119
E	1.500	1.700	0.059	0.067
E1	2.650	2.950	0.104	0.116
e	0.950 BSC		0.037 BSC	
e1	1.900 BSC		0.075 BSC	
L	0.300	0.600	0.012	0.024
θ	0°	8°	0°	8°

NOTES:

1. Body dimensions do not include mode flash or protrusion.
2. This drawing is subject to change without notice.

PACKAGE OUTLINE DIMENSIONS

SOT-23-6

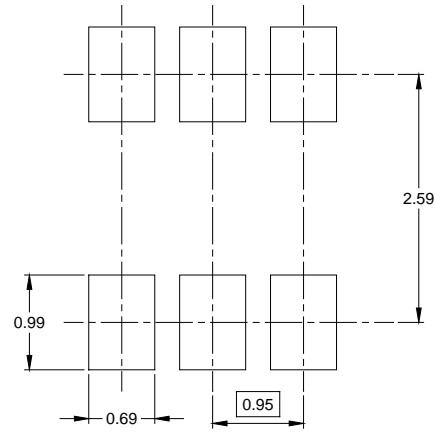
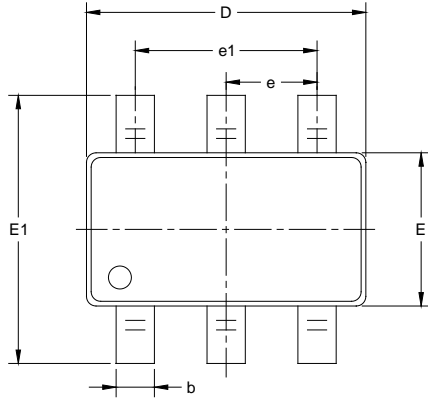

RECOMMENDED LAND PATTERN (Unit: mm)

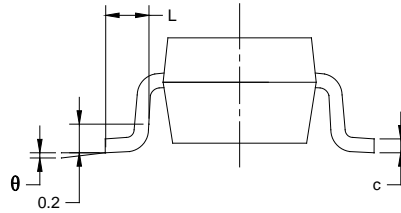
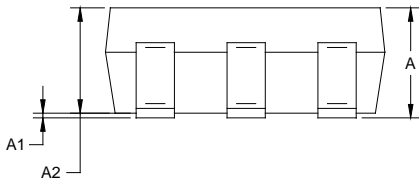

Symbol	Dimensions In Millimeters		Dimensions In Inches	
	MIN	MAX	MIN	MAX
A	1.050	1.250	0.041	0.049
A1	0.000	0.100	0.000	0.004
A2	1.050	1.150	0.041	0.045
b	0.300	0.500	0.012	0.020
c	0.100	0.200	0.004	0.008
D	2.820	3.020	0.111	0.119
E	1.500	1.700	0.059	0.067
E1	2.650	2.950	0.104	0.116
e	0.950 BSC		0.037 BSC	
e1	1.900 BSC		0.075 BSC	
L	0.300	0.600	0.012	0.024
θ	0°	8°	0°	8°

NOTES:

1. Body dimensions do not include mode flash or protrusion.
2. This drawing is subject to change without notice.

PACKAGE OUTLINE DIMENSIONS

SOIC-8

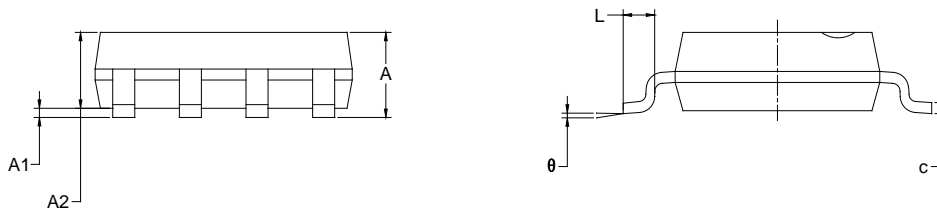
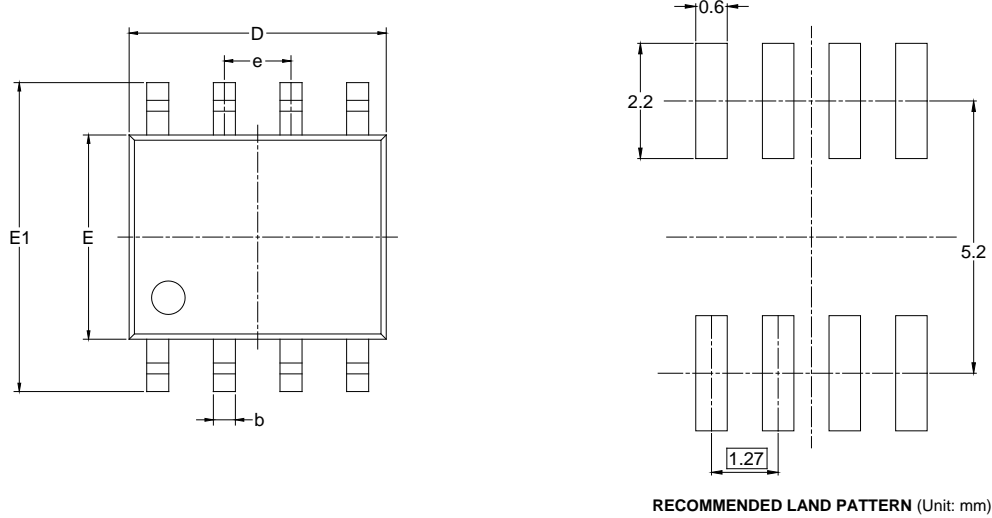

Symbol	Dimensions In Millimeters		Dimensions In Inches	
	MIN	MAX	MIN	MAX
A	1.350	1.750	0.053	0.069
A1	0.100	0.250	0.004	0.010
A2	1.350	1.550	0.053	0.061
b	0.330	0.510	0.013	0.020
c	0.170	0.250	0.006	0.010
D	4.700	5.100	0.185	0.200
E	3.800	4.000	0.150	0.157
E1	5.800	6.200	0.228	0.244
e	1.27 BSC		0.050 BSC	
L	0.400	1.270	0.016	0.050
θ	0°	8°	0°	8°

NOTES:
 1. Body dimensions do not include mode flash or protrusion.
 2. This drawing is subject to change without notice.

PACKAGE OUTLINE DIMENSIONS

MSOP-8

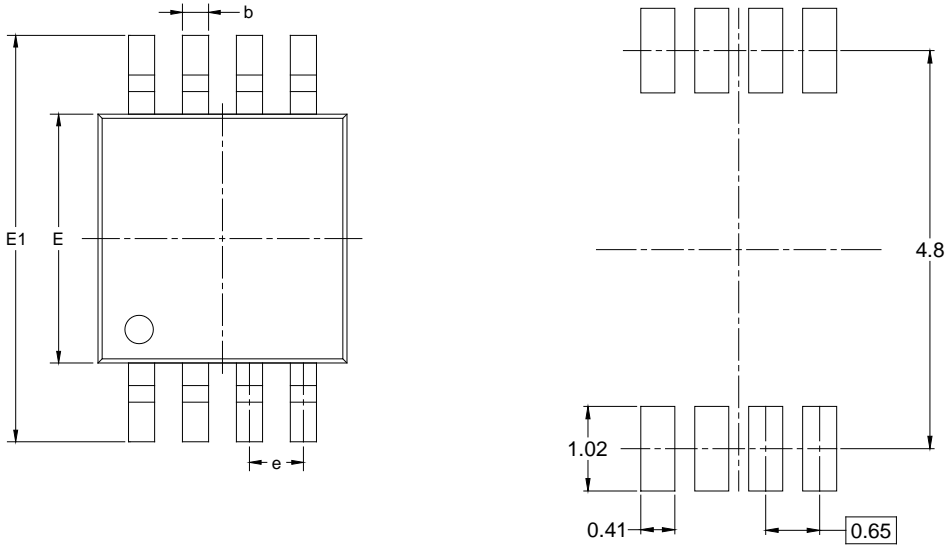

RECOMMENDED LAND PATTERN (Unit: mm)

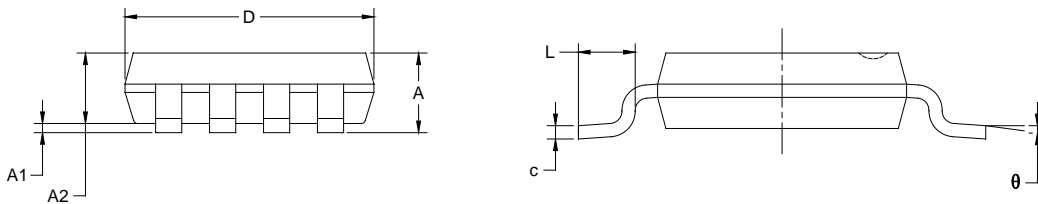

Symbol	Dimensions In Millimeters		Dimensions In Inches	
	MIN	MAX	MIN	MAX
A	0.820	1.100	0.032	0.043
A1	0.020	0.150	0.001	0.006
A2	0.750	0.950	0.030	0.037
b	0.250	0.380	0.010	0.015
c	0.090	0.230	0.004	0.009
D	2.900	3.100	0.114	0.122
E	2.900	3.100	0.114	0.122
E1	4.750	5.050	0.187	0.199
e	0.650 BSC		0.026 BSC	
L	0.400	0.800	0.016	0.031
θ	0°	6°	0°	6°

NOTES:

1. Body dimensions do not include mode flash or protrusion.
2. This drawing is subject to change without notice.

PACKAGE OUTLINE DIMENSIONS

MSOP-10

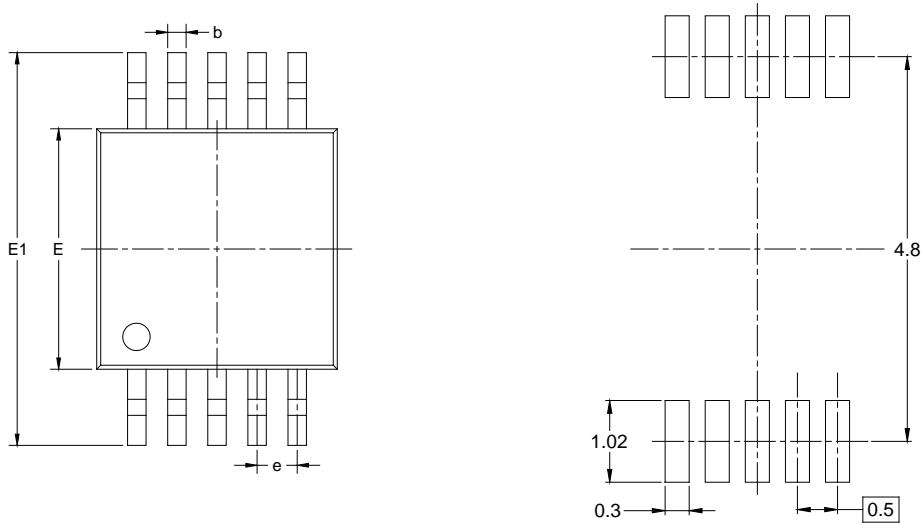

RECOMMENDED LAND PATTERN (Unit: mm)

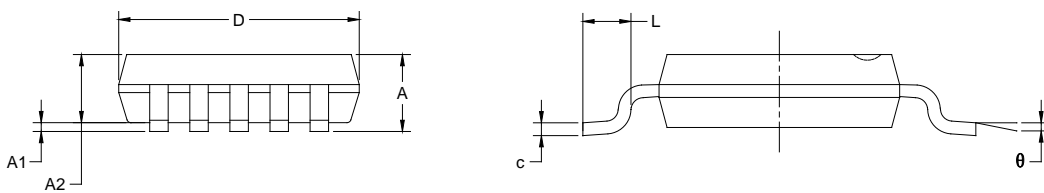

Symbol	Dimensions In Millimeters		Dimensions In Inches	
	MIN	MAX	MIN	MAX
A	0.820	1.100	0.032	0.043
A1	0.020	0.150	0.001	0.006
A2	0.750	0.950	0.030	0.037
b	0.180	0.280	0.007	0.011
c	0.090	0.230	0.004	0.009
D	2.900	3.100	0.114	0.122
E	2.900	3.100	0.114	0.122
E1	4.750	5.050	0.187	0.199
e	0.500 BSC		0.020 BSC	
L	0.400	0.800	0.016	0.031
θ	0°	6°	0°	6°

NOTES:

1. Body dimensions do not include mode flash or protrusion.
2. This drawing is subject to change without notice.

PACKAGE INFORMATION

TAPE AND REEL INFORMATION

REEL DIMENSIONS



TAPE DIMENSIONS



NOTE: The picture is only for reference. Please make the object as the standard.

KEY PARAMETER LIST OF TAPE AND REEL

Package Type	Reel Diameter	Reel Width W1 (mm)	A0 (mm)	B0 (mm)	K0 (mm)	P0 (mm)	P1 (mm)	P2 (mm)	W (mm)	Pin1 Quadrant
SOT-23-5	7"	9.5	3.20	3.20	1.40	4.0	4.0	2.0	8.0	Q3
SOT-23-6	7"	9.5	3.17	3.23	1.37	4.0	4.0	2.0	8.0	Q3
SOIC-8	13"	12.4	6.40	5.40	2.10	4.0	8.0	2.0	12.0	Q1
MSOP-8	13"	12.4	5.20	3.30	1.50	4.0	8.0	2.0	12.0	Q1
MSOP-10	13"	12.4	5.20	3.30	1.20	4.0	8.0	2.0	12.0	Q1

D20001

PACKAGE INFORMATION

CARTON BOX DIMENSIONS



NOTE: The picture is only for reference. Please make the object as the standard.

KEY PARAMETER LIST OF CARTON BOX

Reel Type	Length (mm)	Width (mm)	Height (mm)	Pizza/Carton
7" (Option)	368	227	224	8
7"	442	410	224	18
13"	386	280	370	5

DD0002