



SGM8255A-1/SGM8255A-2

8.5MHz, High Voltage, High Precision, Low Noise, Operational Amplifiers

GENERAL DESCRIPTION

The single SGM8255A-1 and dual SGM8255A-2 are high voltage, low noise and high precision operational amplifiers which can operate from 4.5V to 36V single supply. These devices provide rail-to-rail output operation.

The SGM8255A-1/2 offer a low offset voltage less than 25 μ V and a low bias current. The combination of characteristics makes the SGM8255A-1/2 good choices for temperature measurements, pressure and position sensors, strain gauge amplifiers and medical instrumentation, or any other 4.5V to 36V applications requiring precision and long-term stability.

The SGM8255A-1 is available in Green SOT-23-5, SOIC-8 and MSOP-8 packages. The SGM8255A-2 is available in Green SOIC-8 and MSOP-8 packages. The SGM8255A-1/2 are rated over the -40°C to +125°C temperature range.

FEATURES

- **Low Offset Voltage: 25 μ V (MAX)**
- **Open-Loop Voltage Gain: 150dB (TYP)**
- **PSRR: 150dB (TYP)**
- **CMRR: 135dB (TYP)**
- **0.1Hz to 10Hz Noise: 0.2 μ V_{P-P}**
- **Input Voltage Noise Density: 12nV/ $\sqrt{\text{Hz}}$ at 1kHz**
- **Gain-Bandwidth Product: 8.5MHz**
- **Overload Recovery Time: 0.7 μ s**
- **Rail-to-Rail Output Swing**
- **Supply Voltage Range: 4.5V to 36V**
- **Low Supply Current: 0.85mA/Amplifier (TYP)**
- **-40°C to +125°C Operating Temperature Range**
- **Small Packaging:**
 - SGM8255A-1 Available in Green SOT-23-5, SOIC-8 and MSOP-8 Packages
 - SGM8255A-2 Available in Green SOIC-8 and MSOP-8 Packages

APPLICATIONS

Pressure Sensors
Temperature Measurements
Precision Current Sensing
Electronic Scales
Strain Gauge Amplifiers
Handheld Test Equipment
Thermocouple Amplifiers
Medical Instrumentation

PACKAGE/ORDERING INFORMATION

MODEL	PACKAGE DESCRIPTION	SPECIFIED TEMPERATURE RANGE	ORDERING NUMBER	PACKAGE MARKING	PACKING OPTION
SGM8255A-1	SOT-23-5	-40°C to +125°C	SGM8255A-1XN5G/TR	GZ8XX	Tape and Reel, 3000
	MSOP-8	-40°C to +125°C	SGM8255A-1XMS8G/TR	SGM8255A1 XMS8 XXXXX	Tape and Reel, 4000
	SOIC-8	-40°C to +125°C	SGM8255A-1XS8G/TR	SGM 8255A1XS8 XXXXX	Tape and Reel, 4000
SGM8255A-2	SOIC-8	-40°C to +125°C	SGM8255A-2XS8G/TR	SGM 8255A2XS8 XXXXX	Tape and Reel, 4000
	MSOP-8	-40°C to +125°C	SGM8255A-2XMS8G/TR	SGM8255A2 XMS8 XXXXX	Tape and Reel, 4000

MARKING INFORMATION

SOT-23-5

(1) XX = Date Code.

YYY X X

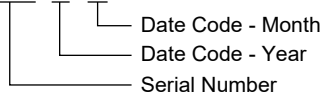

MSOP-8/SOIC-8

(2) XXXXX = Date Code and Vendor Code.

XXXXX

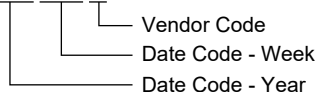

SGM8255A-2: SOIC-8

(3) XXXXX = Date Code, Trace Code and Vendor Code.

XXXXX



Green (RoHS & HSF): SG Micro Corp defines "Green" to mean Pb-Free (RoHS compatible) and free of halogen substances. If you have additional comments or questions, please contact your SGMICRO representative directly.

ABSOLUTE MAXIMUM RATINGS

Supply Voltage.....	40V
Input Voltage Range.....	(-V _S) - 0.3V to (+V _S) + 0.3V
Differential Input Voltage Range.....	-1V to +1V
Package Thermal Resistance @ T _A = +25°C	
SOT-23-5, θ _{JA}	183°C/W
SOT-23-5, θ _{JC}	71°C/W
SOIC-8, θ _{JA}	105°C/W
SOIC-8, θ _{JB}	57°C/W
SOIC-8, θ _{JC}	43.5°C/W
Junction Temperature.....	+150°C
Storage Temperature Range.....	-65°C to +150°C
Lead Temperature (Soldering, 10s).....	+260°C
ESD Susceptibility	
HBM.....	6000V
MM.....	300V
CDM.....	1000V

RECOMMENDED OPERATING CONDITIONS

Operating Voltage Range.....	4.5V to 36V
Operating Temperature Range.....	-40°C to +125°C

OVERSTRESS CAUTION

Stresses beyond those listed in Absolute Maximum Ratings may cause permanent damage to the device. Exposure to absolute maximum rating conditions for extended periods may affect reliability. Functional operation of the device at any conditions beyond those indicated in the Recommended Operating Conditions section is not implied.

ESD SENSITIVITY CAUTION

This integrated circuit can be damaged if ESD protections are not considered carefully. SGMICRO recommends that all integrated circuits be handled with appropriate precautions. Failure to observe proper handling and installation procedures can cause damage. ESD damage can range from subtle performance degradation to complete device failure. Precision integrated circuits may be more susceptible to damage because even small parametric changes could cause the device not to meet the published specifications.

DISCLAIMER

SG Micro Corp reserves the right to make any change in circuit design, or specifications without prior notice.

PIN CONFIGURATIONS

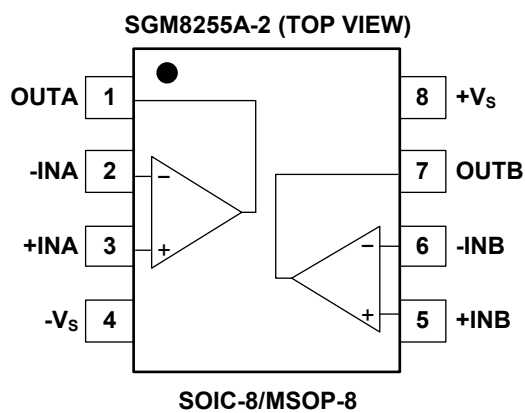
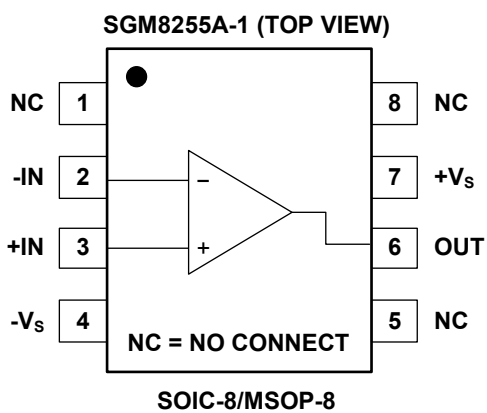
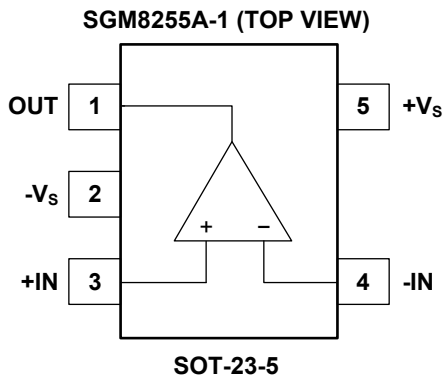

ELECTRICAL CHARACTERISTICS

(At $T_A = +25^\circ\text{C}$, $V_S = \pm 2.5\text{V}$ to $V_S = \pm 18\text{V}$, $V_{CM} = 0\text{V}$ and $R_L = 10\text{k}\Omega$ connected to 0V , Full = -40°C to $+125^\circ\text{C}$, unless otherwise noted.)

PARAMETER	CONDITIONS	TEMP	MIN	TYP	MAX	UNITS
Input Characteristics						
Input Offset Voltage (V_{OS})		+25°C		4	25	μV
		Full			30	
Input Offset Voltage Drift ($\Delta V_{OS}/\Delta T$)		Full		18		nV/°C
Input Bias Current (I_B)		+25°C		±100	±400	pA
Input Offset Current (I_{OS})		+25°C		±200	±600	
Input Common Mode Voltage Range (V_{CM})		Full	$(-V_S) - 0.05$		$(+V_S) - 1.5$	V
Common Mode Rejection Ratio ⁽¹⁾ (CMRR)	$V_{CM} = (-V_S) - 0.05\text{V}$ to $(+V_S) - 1.5\text{V}$	+25°C	118	135		dB
		Full	115			
Open-Loop Voltage Gain (A_{OL})	$V_S = \pm 2.5\text{V}$, $V_{OUT} = \pm 2.0\text{V}$	+25°C	120	150		dB
		Full	117			
	$V_S = \pm 18\text{V}$, $V_{OUT} = \pm 17.5\text{V}$	+25°C	134	155		
		Full	131			
Output Characteristics						
Output Voltage Swing from Rail	$V_S = \pm 2.5\text{V}$	+25°C		12	18	mV
		Full			25	
	$V_S = \pm 18\text{V}$	+25°C		88	135	
		Full			165	
Output Short-Circuit Current (I_{SC})	$V_S = \pm 2.5\text{V}$	+25°C	±24	±35		mA
		Full	±13			
	$V_S = \pm 18\text{V}$	+25°C	±60	±70		
		Full	±39			
Power Supply						
Operating Voltage Range (V_S)		Full	4.5		36	V
Quiescent Current/Amplifier (I_Q)	$I_{OUT} = 0$	+25°C		0.85	1.1	mA
		Full			1.2	
Power Supply Rejection Ratio ⁽¹⁾ (PSRR)	$V_S = 4.5\text{V}$ to 36V	+25°C	128	150		dB
		Full	125			
Dynamic Performance						
Gain-Bandwidth Product (GBP)	$V_{OUT} = 100\text{mV}_{P-P}$, $C_L = 10\text{pF}$	+25°C		8.5		MHz
Slew Rate (SR)		+25°C		5		V/μs
Settling Time to 0.1% (t_s)	$V_{IN} = 1\text{V Step}$, $A_V = +1$	+25°C		0.8		μs
Overload Recovery Time	$V_{IN} \times A_V > V_S$	+25°C		0.7		μs
Total Harmonic Distortion + Noise (THD+N)	$V_{IN} = 2\text{V}_{P-P}$, $A_V = +1$, $f = 1\text{kHz}$	+25°C		0.0003		%
Noise						
Input Voltage Noise	$f = 0.1\text{Hz}$ to 10Hz	+25°C		0.2		μV _{P-P}
Input Voltage Noise Density (e_n)	$f = 0.1\text{kHz}$	+25°C		12		nV/√Hz
	$f = 1\text{kHz}$	+25°C		12		
	$f = 10\text{kHz}$	+25°C		13		
		+25°C				

NOTE 1: PSRR and CMRR are affected by the matching between external gain-setting resistor ratios.

TYPICAL PERFORMANCE CHARACTERISTICS

At $T_A = +25^\circ\text{C}$, $V_S = \pm 15\text{V}$, $C_L = 10\text{pF}$ and $R_L = 10\text{k}\Omega$, unless otherwise noted.

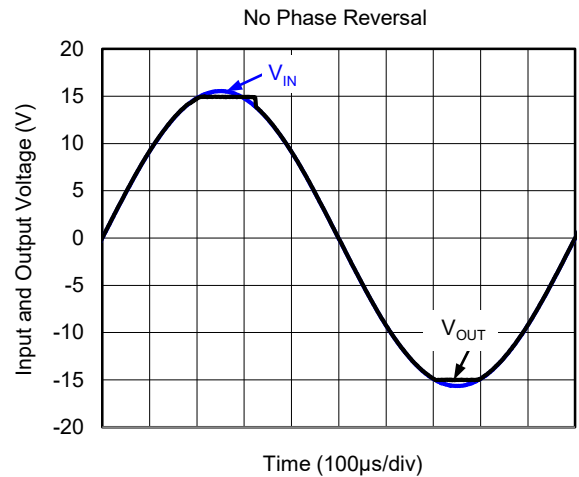
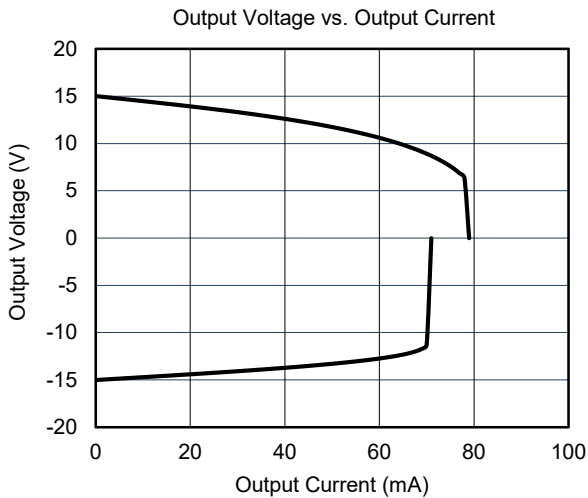
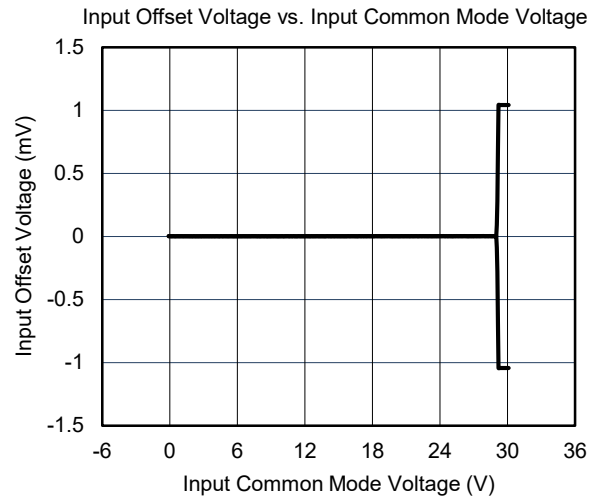
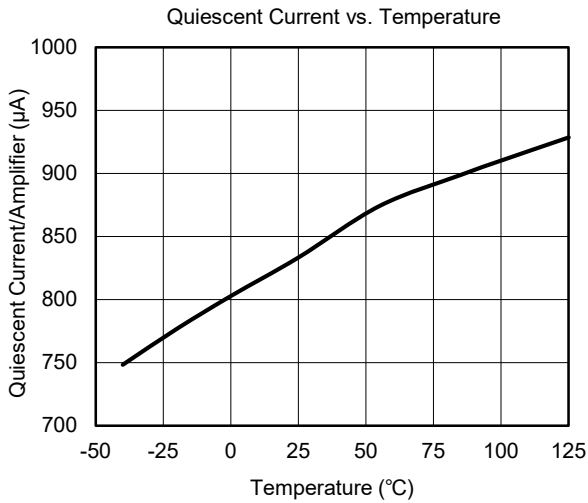
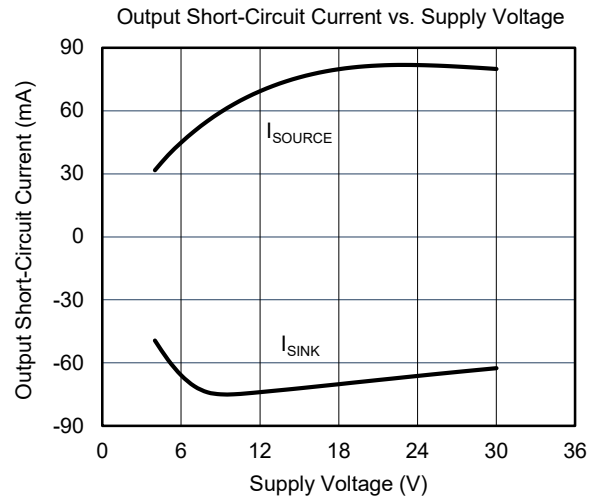
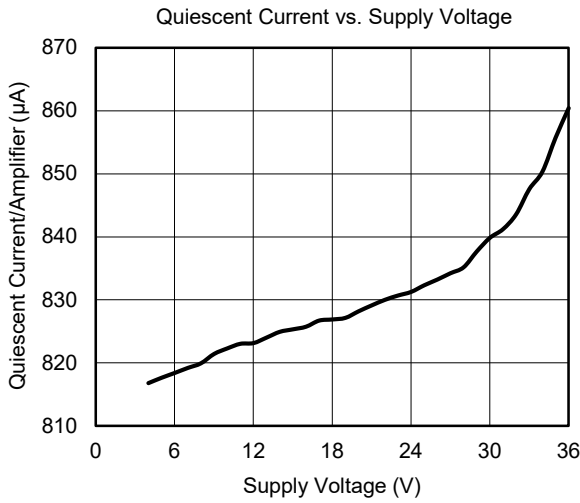

TYPICAL PERFORMANCE CHARACTERISTICS (continued)

At $T_A = +25^\circ\text{C}$, $V_S = \pm 15\text{V}$, $C_L = 10\text{pF}$ and $R_L = 10\text{k}\Omega$, unless otherwise noted.

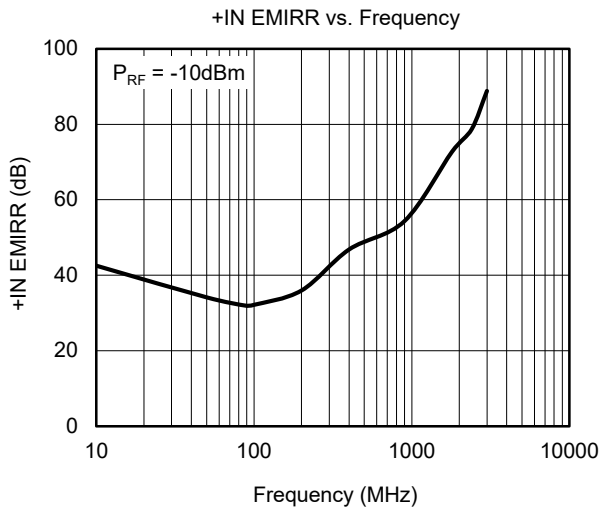
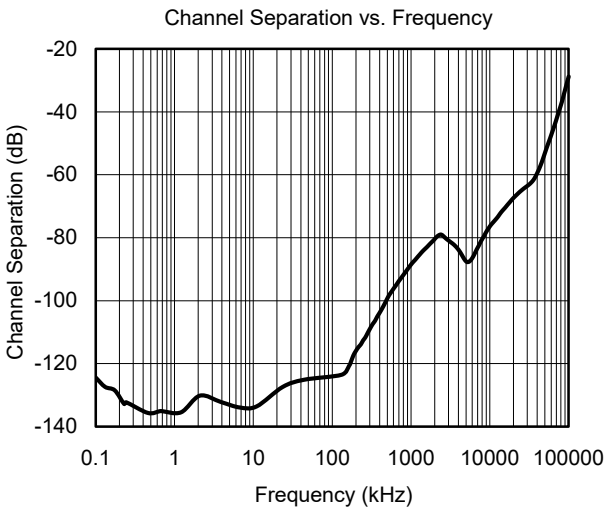
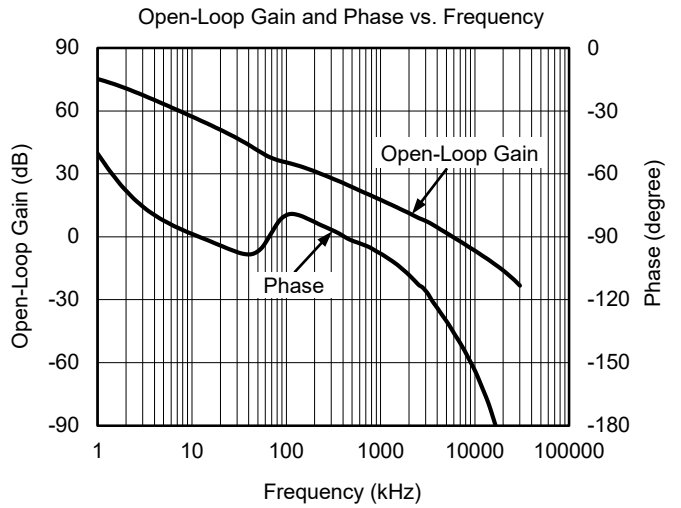
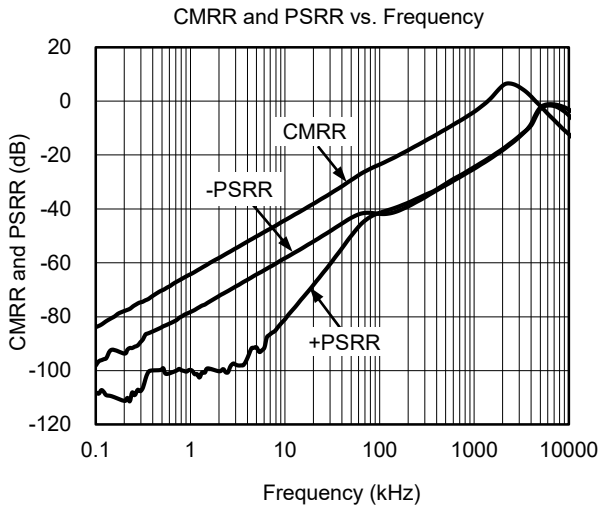
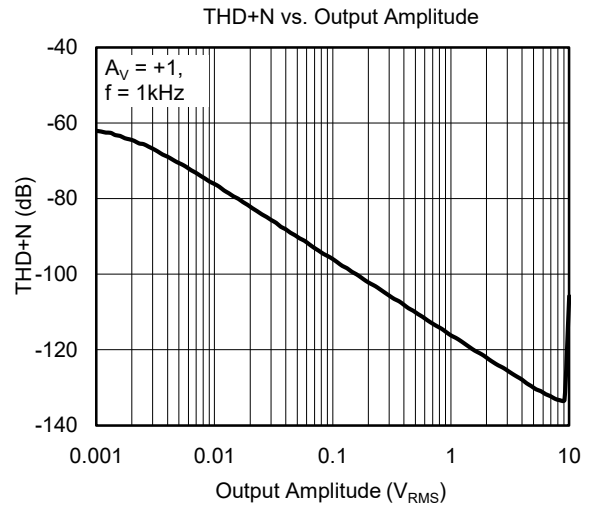
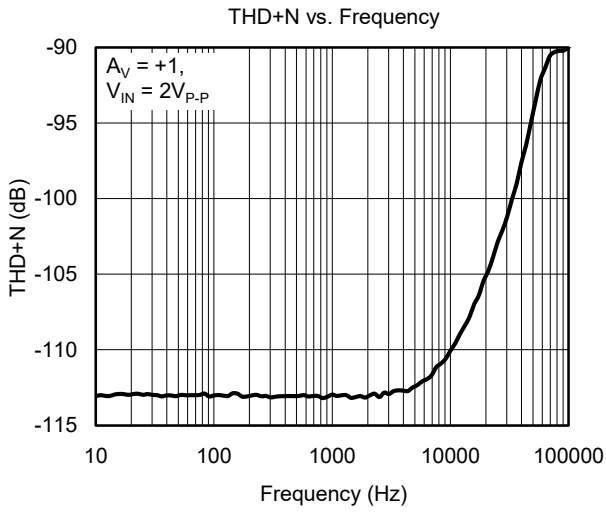

TYPICAL PERFORMANCE CHARACTERISTICS (continued)

At $T_A = +25^\circ\text{C}$, $V_S = \pm 15\text{V}$, $C_L = 10\text{pF}$ and $R_L = 10\text{k}\Omega$, unless otherwise noted.

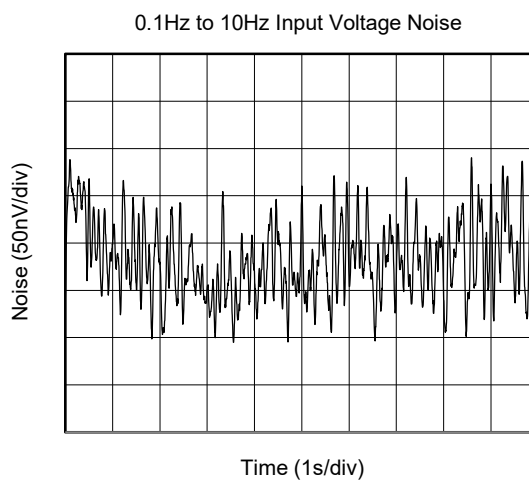
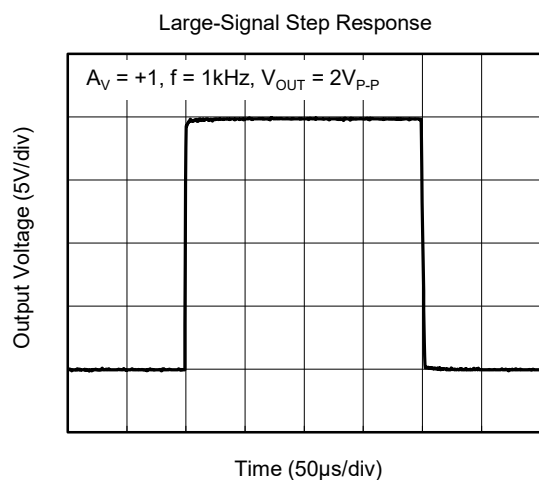
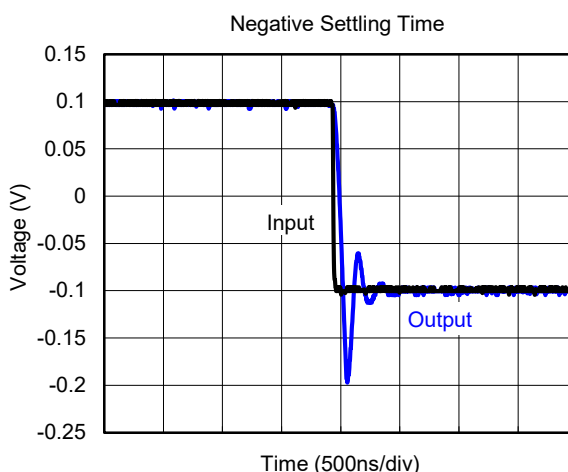
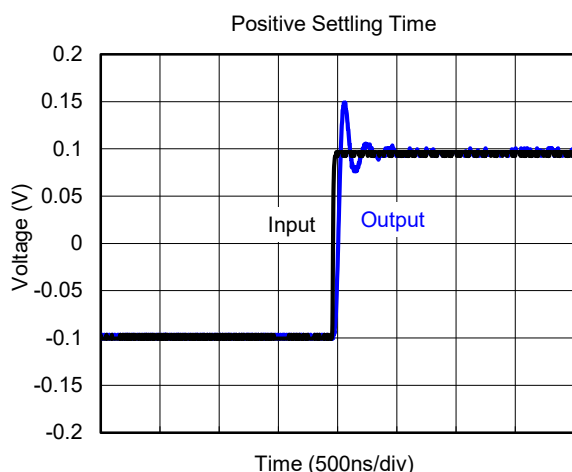
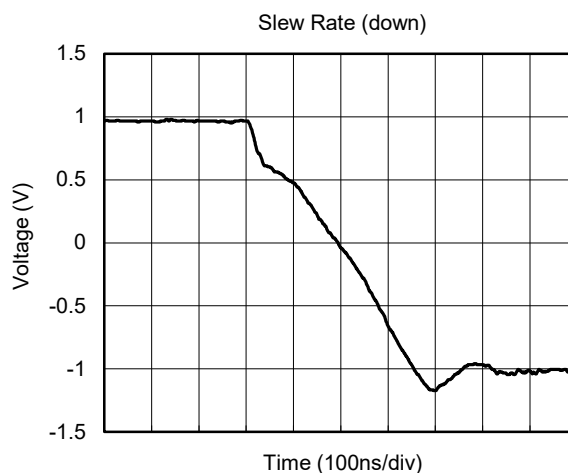
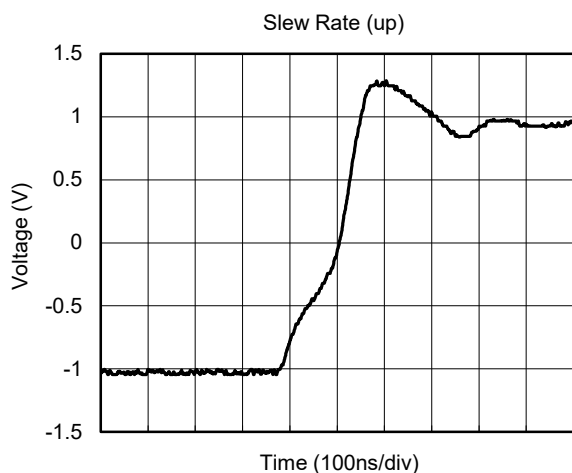

TYPICAL PERFORMANCE CHARACTERISTICS (continued)

At $T_A = +25^\circ\text{C}$, $V_S = \pm 15\text{V}$, $C_L = 10\text{pF}$ and $R_L = 10\text{k}\Omega$, unless otherwise noted.

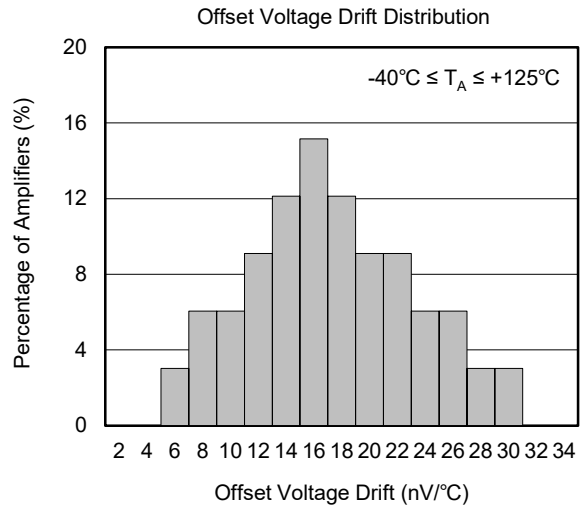
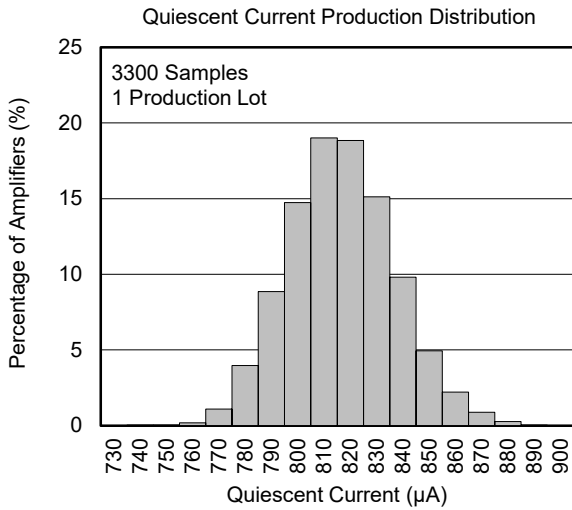
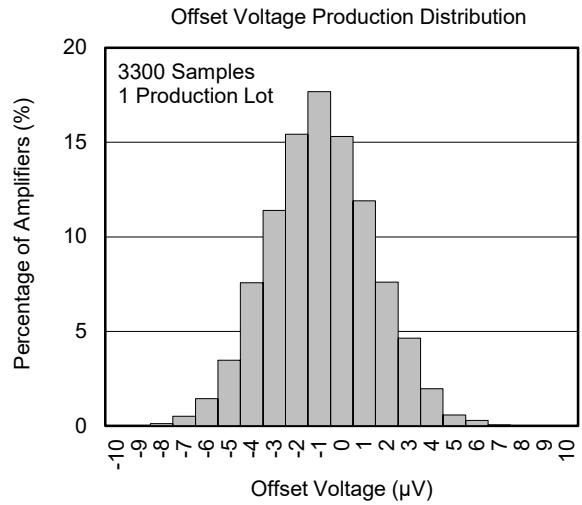
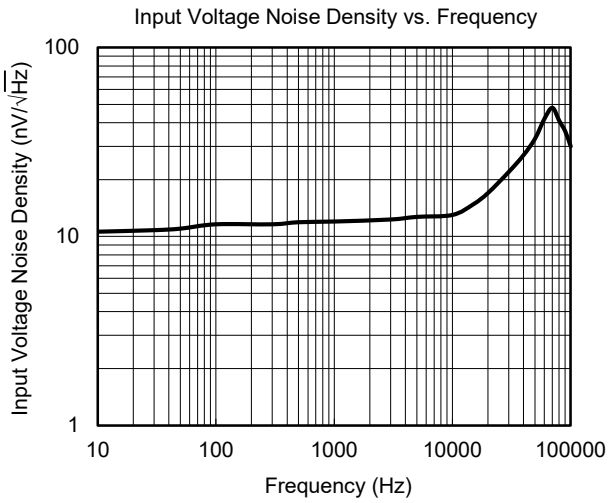

REVISION HISTORY

NOTE: Page numbers for previous revisions may differ from page numbers in the current version.

NOVEMBER 2020 – REV.A.1 to REV.A.2	Page
Updated Marking Information section.....	2

JUNE 2020 – REV.A to REV.A.1	Page
Updated Absolute Maximum Ratings section.....	2

Changes from Original (DECEMBER 2017) to REV.A	Page
Changed from product preview to production data.....	All

PACKAGE INFORMATION

PACKAGE OUTLINE DIMENSIONS

SOT-23-5

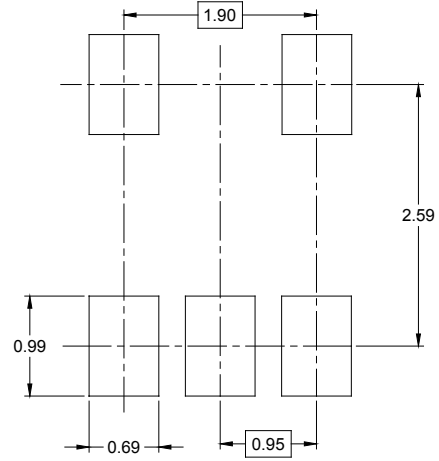
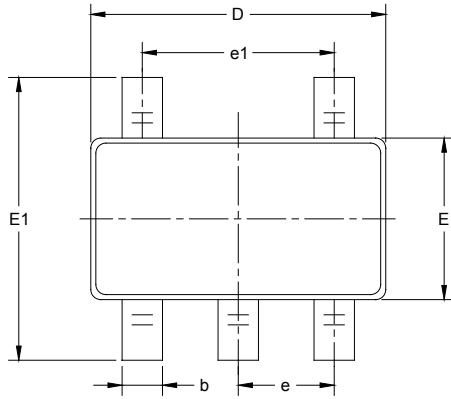

RECOMMENDED LAND PATTERN (Unit: mm)

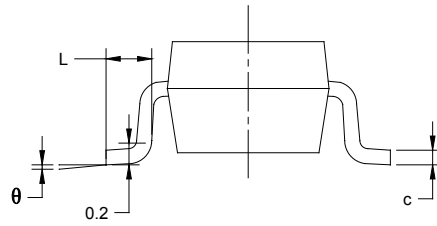
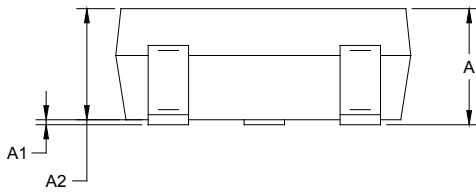

Symbol	Dimensions In Millimeters		Dimensions In Inches	
	MIN	MAX	MIN	MAX
A	1.050	1.250	0.041	0.049
A1	0.000	0.100	0.000	0.004
A2	1.050	1.150	0.041	0.045
b	0.300	0.500	0.012	0.020
c	0.100	0.200	0.004	0.008
D	2.820	3.020	0.111	0.119
E	1.500	1.700	0.059	0.067
E1	2.650	2.950	0.104	0.116
e	0.950 BSC		0.037 BSC	
e1	1.900 BSC		0.075 BSC	
L	0.300	0.600	0.012	0.024
θ	0°	8°	0°	8°

PACKAGE OUTLINE DIMENSIONS

SOIC-8

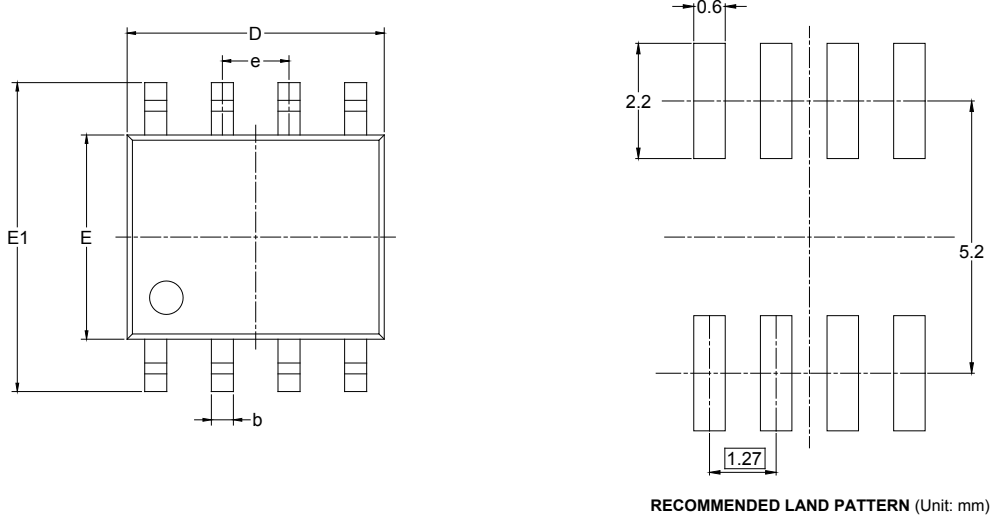

Symbol	Dimensions In Millimeters		Dimensions In Inches	
	MIN	MAX	MIN	MAX
A	1.350	1.750	0.053	0.069
A1	0.100	0.250	0.004	0.010
A2	1.350	1.550	0.053	0.061
b	0.330	0.510	0.013	0.020
c	0.170	0.250	0.006	0.010
D	4.700	5.100	0.185	0.200
E	3.800	4.000	0.150	0.157
E1	5.800	6.200	0.228	0.244
e	1.27 BSC		0.050 BSC	
L	0.400	1.270	0.016	0.050
θ	0°	8°	0°	8°

PACKAGE OUTLINE DIMENSIONS

MSOP-8



RECOMMENDED LAND PATTERN (Unit: mm)

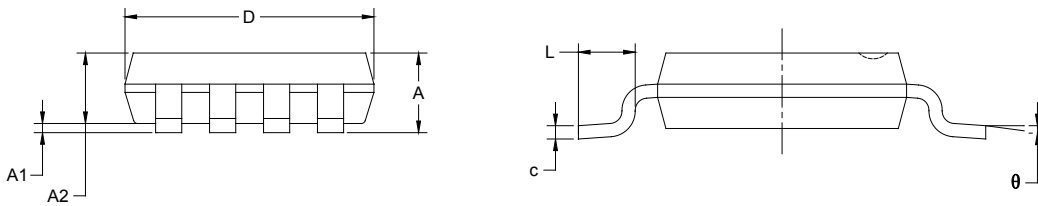

Symbol	Dimensions In Millimeters		Dimensions In Inches	
	MIN	MAX	MIN	MAX
A	0.820	1.100	0.032	0.043
A1	0.020	0.150	0.001	0.006
A2	0.750	0.950	0.030	0.037
b	0.250	0.380	0.010	0.015
c	0.090	0.230	0.004	0.009
D	2.900	3.100	0.114	0.122
E	2.900	3.100	0.114	0.122
E1	4.750	5.050	0.187	0.199
e	0.650 BSC		0.026 BSC	
L	0.400	0.800	0.016	0.031
θ	0°	6°	0°	6°

PACKAGE INFORMATION

TAPE AND REEL INFORMATION

REEL DIMENSIONS



TAPE DIMENSIONS



NOTE: The picture is only for reference. Please make the object as the standard.

KEY PARAMETER LIST OF TAPE AND REEL

Package Type	Reel Diameter	Reel Width W1 (mm)	A0 (mm)	B0 (mm)	K0 (mm)	P0 (mm)	P1 (mm)	P2 (mm)	W (mm)	Pin1 Quadrant
SOT-23-5	7"	9.5	3.20	3.20	1.40	4.0	4.0	2.0	8.0	Q3
SOIC-8	13"	12.4	6.40	5.40	2.10	4.0	8.0	2.0	12.0	Q1
MSOP-8	13"	12.4	5.20	3.30	1.50	4.0	8.0	2.0	12.0	Q1

DD0001

PACKAGE INFORMATION

CARTON BOX DIMENSIONS



NOTE: The picture is only for reference. Please make the object as the standard.

KEY PARAMETER LIST OF CARTON BOX

Reel Type	Length (mm)	Width (mm)	Height (mm)	Pizza/Carton
7" (Option)	368	227	224	8
7"	442	410	224	18
13"	386	280	370	5

DD0002