



# SGM8291/SGM8292/SGM8294 High Voltage Rail-to-Rail Output Operational Amplifiers

## GENERAL DESCRIPTION

The SGM8291 (single), SGM8292 (dual) and SGM8294 (quad) are high voltage operational amplifiers, which can operate from 4.5V to 36V single supply or from  $\pm 2.25V$  to  $\pm 18V$  dual power supplies. They provide a wide input common mode voltage range and rail-to-rail output voltage swing.

The SGM8291/2/4 provide high slew rate, low offset, drift and bias current.

The SGM8291 is available in Green SOT-23-5, MSOP-8 and SOIC-8 packages. The SGM8292 is available in Green SOIC-8 and MSOP-8 packages. The SGM8294 is available in Green SOIC-14 and TSSOP-14 packages. They are specified over the extended  $-40^{\circ}C$  to  $+125^{\circ}C$  temperature range.

## FEATURES

- Rail-to-Rail Output
- Wide Input Common Mode Voltage Range
- Low Offset Voltage: 1.5mV (MAX)
- Low Input Bias Current
- Low Input Offset Current
- Low Quiescent Current: 150 $\mu$ A/Amplifier
- Output Short-Circuit Protection
- High Input Impedance
- High Slew Rate: 7V/ $\mu$ s
- Small Packaging:
  - SGM8291 Available in Green SOT-23-5, MSOP-8 and SOIC-8 Packages
  - SGM8292 Available in Green MSOP-8 and SOIC-8 Packages
  - SGM8294 Available in Green TSSOP-14 and SOIC-14 Packages

## APPLICATIONS

High Impedance Sensor  
Precision Instrumentation  
Photodiode Amplifier  
Phase-Locked Loop Filter  
High End, Professional Audio  
Medical  
ATE  
DAC Output Amplifier



**ABSOLUTE MAXIMUM RATINGS**

Supply Voltage, +Vs to -Vs .....	40V
Input Common Mode Voltage Range .....	(-Vs) - 0.1V to (+Vs) - 1.5V
Input/Output Voltage Range .....	(-Vs) - 0.3V to (+Vs) + 0.3V
Differential Input Voltage.....	1.5V
Junction Temperature.....	+150°C
Storage Temperature Range .....	-65°C to +150°C
Lead Temperature (Soldering, 10s).....	+260°C
ESD Susceptibility	
HBM.....	4000V
MM (SGM8291/2) .....	150V
MM (SGM8294) .....	200V

**RECOMMENDED OPERATING CONDITIONS**

Operating Temperature Range .....	-40°C to +125°C
-----------------------------------	-----------------

**NOTE:**

1. Proper power supply sequencing is recommended for the CMOS device. Always sequence Vs on first, followed by the inputs and outputs.

**OVERSTRESS CAUTION**

Stresses beyond those listed in Absolute Maximum Ratings may cause permanent damage to the device. Exposure to absolute maximum rating conditions for extended periods may affect reliability. Functional operation of the device at any conditions beyond those indicated in the Recommended Operating Conditions section is not implied.

**ESD SENSITIVITY CAUTION**

This integrated circuit can be damaged if ESD protections are not considered carefully. SGMICRO recommends that all integrated circuits be handled with appropriate precautions. Failure to observe proper handling and installation procedures can cause damage. ESD damage can range from subtle performance degradation to complete device failure. Precision integrated circuits may be more susceptible to damage because even small parametric changes could cause the device not to meet the published specifications.

**DISCLAIMER**

SG Micro Corp reserves the right to make any change in circuit design, or specifications without prior notice.

**PIN CONFIGURATIONS**

**SGM8291AYN5G (TOP VIEW)**

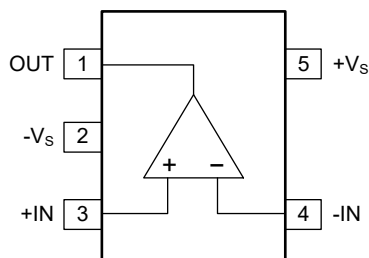

**SOT-23-5**

**SGM8291BYN5G (TOP VIEW)**

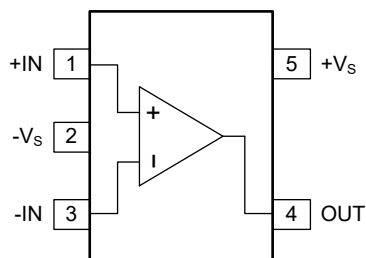

**SOT-23-5**

**SGM8291 (TOP VIEW)**

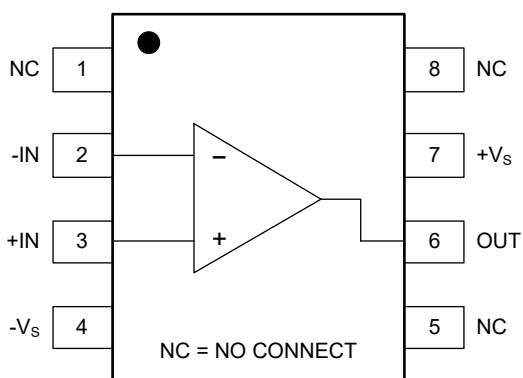

**SOIC-8/MSOP-8**

**SGM8292 (TOP VIEW)**

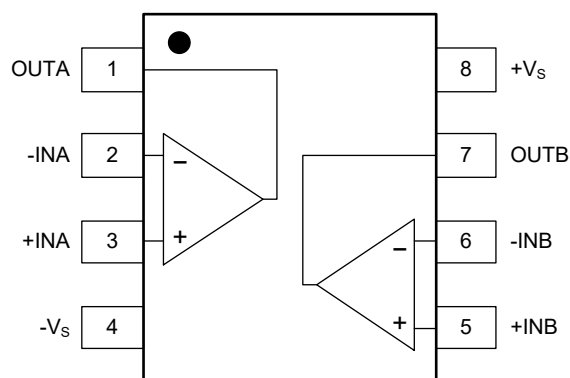

**SOIC-8/MSOP-8**

**SGM8294 (TOP VIEW)**

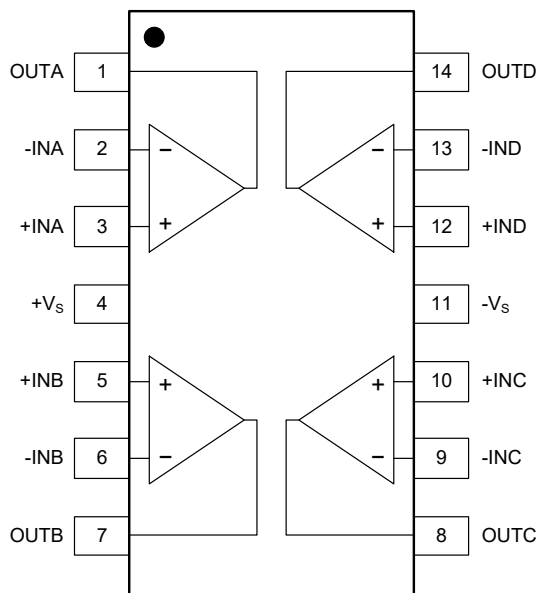

**SOIC-14/TSSOP-14**

**ELECTRICAL CHARACTERISTICS**

( $V_S = +5V$ ,  $R_L = 2k\Omega$  connected to 2.5V, unless otherwise noted.)

PARAMETER	CONDITIONS	SGM8291/2/4						
		TYP	MIN/MAX OVER TEMPERATURE				UNITS	MIN/MAX
		+25°C	+25°C	-40°C to +85°C	-40°C to +125°C			
Input Offset Voltage ( $V_{OS}$ )	$V_{CM} = 2.5V$	0.3	1.5	2.4	2.75	mV	MAX	
Input Offset Voltage Drift ( $\Delta V_{OS}/\Delta T$ )		3				$\mu V/^\circ C$	TYP	
Input Bias Current ( $I_B$ )		20				pA	TYP	
Input Offset Current ( $I_{OS}$ )		20				pA	TYP	
Open-Loop Voltage Gain ( $A_{OL}$ )	$V_{OUT} = 0.5V$ to $4.5V$ , $R_L = 5k\Omega$	86	75	72	70	dB	MIN	
Output Voltage Swing from Rail	$V_{OH}$ $R_L = 10k\Omega$	16	39	43	46	mV	MAX	
	$V_{OL}$ $R_L = 10k\Omega$	14	30	34	38	mV	MAX	
Output Short-Circuit Current ( $I_{SC}$ )	Sink $R_L = 10\Omega$	46.2	34.1	21.5	11.0	mA	MIN	
	Source $R_L = 10\Omega$	44.4	30.5	20.7	12.3			
Input Common Mode Voltage Range ( $V_{CM}$ )		-0.1 to 3.5				V	TYP	
Common Mode Rejection Ratio (CMRR)	$V_{CM} = -0.1V$ to $3.5V$	84	67	62	60	dB	MIN	
Power Supply Rejection Ratio (PSRR)	$V_S = 4.5V$ to $36V$	103	82	80	78	dB	MIN	
Quiescent Current/Amplifier	$I_{OUT} = 0A$	144	275	309	329	$\mu A$	MAX	
Gain-Bandwidth Product (GBP)	$C_L = 100pF$ , $V_{CM} = 2.5V$	1.4				MHz	TYP	
Gain Margin	$C_L = 100pF$ , $V_{CM} = 2.5V$	-10				dB	TYP	
Phase Margin	$C_L = 100pF$ , $V_{CM} = 2.5V$	50				$^\circ$	TYP	
Channel-to-Channel Crosstalk	$f = 1MHz$	-80				dB	TYP	
Slew Rate (SR)	Up $V_{OUT} = 2V_{PP}$ step, $C_L = 100pF$ , $A_V = 1$	5				$V/\mu s$	TYP	
	Down $V_{OUT} = 2V_{PP}$ step, $C_L = 100pF$ , $A_V = 1$	5				$V/\mu s$	TYP	
Overload Recovery Time (ORT)	Up $V_{IN} \times Gain = V_S$	2.0				$\mu s$	TYP	
	Down $V_{IN} \times Gain = V_S$	4.0						
Settling Time ( $t_s$ )	$C_L = 100pF$ , $A_V = 1$ , 200mV output step	2				$\mu s$	TYP	
Input Voltage Noise Density ( $e_n$ )	$f = 20kHz$ , $V_{CM} = 2.5V$	30				$nV/\sqrt{Hz}$	TYP	
	$f = 1kHz$ , $V_{CM} = 2.5V$	45						
Total Harmonic Distortion + Noise (THD+N)	$V_{OUT} = 2V_{PP}$ , $f = 1kHz$ , $A_V = 1$ , $R_L = 600\Omega$	0.018				%	TYP	
	$V_{OUT} = 2V_{PP}$ , $f = 1kHz$ , $A_V = 1$ , $R_L = 2k\Omega$	0.009						

**ELECTRICAL CHARACTERISTICS (continued)**

( $V_S = \pm 5V$ ,  $R_L = 2k\Omega$  connected to 0V, unless otherwise noted.)

PARAMETER	CONDITIONS	SGM8291/2/4						
		TYP	MIN/MAX OVER TEMPERATURE				UNITS	MIN/MAX
		+25°C	+25°C	-40°C to +85°C	-40°C to +125°C			
Input Offset Voltage ( $V_{OS}$ )	$V_{CM} = 0V$	0.3	1.5	2.4	2.75	mV	MAX	
Input Offset Voltage Drift ( $\Delta V_{OS}/\Delta T$ )		3				$\mu V/^\circ C$	TYP	
Input Bias Current ( $I_B$ )		20				pA	TYP	
Input Offset Current ( $I_{OS}$ )		20				pA	TYP	
Open-Loop Voltage Gain ( $A_{OL}$ )	$V_{OUT} = -4.5V$ to $4.5V$ , $R_L = 5k\Omega$	93	81	78	76	dB	MIN	
Output Voltage Swing from Rail	$V_{OH}$ $R_L = 10k\Omega$	28	67	73	79	mV	MAX	
	$V_{OL}$ $R_L = 10k\Omega$	23	39	47	62	mV	MAX	
Output Current ( $I_{OUT}$ )		60				mA	TYP	
Input Common Mode Voltage Range ( $V_{CM}$ )		-5.1 to 3.5				V	TYP	
Common Mode Rejection Ratio (CMRR)	$V_{CM} = -5.1V$ to $3.5V$	92	75	68	66	dB	MIN	
Quiescent Current/Amplifier	$I_{OUT} = 0A$	145	276	311	332	$\mu A$	MAX	
Gain-Bandwidth Product (GBP)	$C_L = 100pF$ , $V_{CM} = 0V$	1.4				MHz	TYP	
Gain Margin	$C_L = 100pF$ , $V_{CM} = 0V$	-10				dB	TYP	
Phase Margin	$C_L = 100pF$ , $V_{CM} = 0V$	50				$^\circ$	TYP	
Channel-to-Channel Crosstalk	$f = 1MHz$	-80				dB	TYP	
Slew Rate (SR)	Up $V_{OUT} = 2V_{PP}$ step, $C_L = 100pF$ , $A_V = 1$	6				$V/\mu s$	TYP	
	Down $V_{OUT} = 2V_{PP}$ step, $C_L = 100pF$ , $A_V = 1$	4				$V/\mu s$	TYP	
Overload Recovery Time (ORT)	Up $V_{IN} \times Gain = V_S$	1.5				$\mu s$	TYP	
	Down $V_{IN} \times Gain = V_S$	2.5						
Settling Time ( $t_s$ )	$C_L = 100pF$ , $A_V = 1$ , 200mV output step	2				$\mu s$	TYP	
Input Voltage Noise Density ( $e_n$ )	$f = 20kHz$ , $V_{CM} = 0V$	30				$nV/\sqrt{Hz}$	TYP	
	$f = 1kHz$ , $V_{CM} = 0V$	45						
Total Harmonic Distortion + Noise (THD+N)	$V_{OUT} = 2V_{PP}$ , $f = 1kHz$ , $A_V = 1$ , $R_L = 600\Omega$	0.018				%	TYP	
	$V_{OUT} = 2V_{PP}$ , $f = 1kHz$ , $A_V = 1$ , $R_L = 2k\Omega$	0.009						

**ELECTRICAL CHARACTERISTICS (continued)**

( $V_S = \pm 15V$ ,  $R_L = 2k\Omega$  connected to 0V, unless otherwise noted.)

PARAMETER	CONDITIONS	SGM8291/2/4						
		TYP	MIN/MAX OVER TEMPERATURE				UNITS	MIN/MAX
		+25°C	+25°C	-40°C to +85°C	-40°C to +125°C			
Input Offset Voltage ( $V_{OS}$ )	$V_{CM} = 0V$	0.3	1.5	2.4	2.75	mV	MAX	
Input Offset Voltage Drift ( $\Delta V_{OS}/\Delta T$ )		3				$\mu V/^\circ C$	TYP	
Input Bias Current ( $I_B$ )		20				pA	TYP	
Input Offset Current ( $I_{OS}$ )		20				pA	TYP	
Open-Loop Voltage Gain ( $A_{OL}$ )	$V_{OUT} = -14.5V$ to $14.5V$ , $R_L = 5k\Omega$	100	85	82	80	dB	MIN	
Output Voltage Swing from Rail	$V_{OH}$ $R_L = 10k\Omega$	67	174	193	210	mV	MAX	
	$V_{OL}$ $R_L = 10k\Omega$	63	102	124	148	mV	MAX	
Output Current ( $I_{OUT}$ )		60				mA	TYP	
Input Common Mode Voltage Range ( $V_{CM}$ )		-15.1 to 13.5				V	TYP	
Common Mode Rejection Ratio (CMRR)	$V_{CM} = -15.1V$ to $13.5V$	95	79	71	66	dB	MIN	
Quiescent Current/Amplifier	$I_{OUT} = 0A$	150	286	320	337	$\mu A$	MAX	
Gain-Bandwidth Product (GBP)	$C_L = 100pF$ , $V_{CM} = 0V$	1.4				MHz	TYP	
Gain Margin	$C_L = 100pF$ , $V_{CM} = 0V$	-10				dB	TYP	
Phase Margin	$C_L = 100pF$ , $V_{CM} = 0V$	50				$^\circ$	TYP	
Channel-to-Channel Crosstalk	$f = 1MHz$	-80				dB	TYP	
Slew Rate (SR)	Up $V_{OUT} = 2V_{PP}$ step, $C_L = 100pF$ , $A_V = 1$	7				$V/\mu s$	TYP	
	Down $V_{OUT} = 2V_{PP}$ step, $C_L = 100pF$ , $A_V = 1$	4				$V/\mu s$	TYP	
Overload Recovery Time (ORT)	Up $V_{IN} \times Gain = V_S$	0.5				$\mu s$	TYP	
	Down $V_{IN} \times Gain = V_S$	1.0						
Settling Time ( $t_s$ )	$C_L = 100pF$ , $A_V = 1$ , 200mV output step	2				$\mu s$	TYP	
Input Voltage Noise Density ( $e_n$ )	$f = 20kHz$ , $V_{CM} = 0V$	29				$nV/\sqrt{Hz}$	TYP	
	$f = 1kHz$ , $V_{CM} = 0V$	43						
Total Harmonic Distortion + Noise (THD+N)	$V_{OUT} = 2V_{PP}$ , $f = 1kHz$ , $A_V = 1$ , $R_L = 600\Omega$	0.018				%	TYP	
	$V_{OUT} = 2V_{PP}$ , $f = 1kHz$ , $A_V = 1$ , $R_L = 2k\Omega$	0.009						

**ELECTRICAL CHARACTERISTICS (continued)**

( $V_S = \pm 18V$ ,  $R_L = 2k\Omega$  connected to 0V, unless otherwise noted.)

PARAMETER	CONDITIONS	SGM8291/2/4						
		TYP	MIN/MAX OVER TEMPERATURE				UNITS	MIN/MAX
		+25°C	+25°C	-40°C to +85°C	-40°C to +125°C			
Input Offset Voltage ( $V_{OS}$ )	$V_{CM} = 0V$	0.3	1.5	2.4	2.75	mV	MAX	
Input Offset Voltage Drift ( $\Delta V_{OS}/\Delta T$ )		3				$\mu V/^\circ C$	TYP	
Input Bias Current ( $I_B$ )		20				pA	TYP	
Input Offset Current ( $I_{OS}$ )		20				pA	TYP	
Open-Loop Voltage Gain ( $A_{OL}$ )	$V_{OUT} = -17.5V$ to $17.5V$ , $R_L = 5k\Omega$	101	87	84	82	dB	MIN	
Output Voltage Swing from Rail	$V_{OH}$ $R_L = 10k\Omega$	81	208	231	251	mV	MAX	
	$V_{OL}$ $R_L = 10k\Omega$	73	119	146	172	mV	MAX	
Output Current ( $I_{OUT}$ )		60				mA	TYP	
Input Common Mode Voltage Range ( $V_{CM}$ )		-18.1 to 16.5				V	TYP	
Common Mode Rejection Ratio (CMRR)	$V_{CM} = -18.1V$ to $16.5V$	91	78	72	69	dB	MIN	
Quiescent Current/Amplifier	$I_{OUT} = 0A$	157	299	332	352	$\mu A$	MAX	
Gain-Bandwidth Product (GBP)	$C_L = 100pF$ , $V_{CM} = 0V$	1.4				MHz	TYP	
Gain Margin	$C_L = 100pF$ , $V_{CM} = 0V$	-10				dB	TYP	
Phase Margin	$C_L = 100pF$ , $V_{CM} = 0V$	50				$^\circ$	TYP	
Channel-to-Channel Crosstalk	$f = 1MHz$	-80				dB	TYP	
Slew Rate (SR)	Up $V_{OUT} = 2V_{PP}$ step, $C_L = 100pF$ , $A_V = 1$	7				$V/\mu s$	TYP	
	Down $V_{OUT} = 2V_{PP}$ step, $C_L = 100pF$ , $A_V = 1$	4				$V/\mu s$	TYP	
Overload Recovery Time (ORT)	Up $V_{IN} \times Gain = V_S$	0.5				$\mu s$	TYP	
	Down $V_{IN} \times Gain = V_S$	1.0						
Settling Time ( $t_s$ )	$C_L = 100pF$ , $A_V = 1$ , 200mV output step	2				$\mu s$	TYP	
Input Voltage Noise Density ( $e_n$ )	$f = 20kHz$ , $V_{CM} = 0V$	29				$nV/\sqrt{Hz}$	TYP	
	$f = 1kHz$ , $V_{CM} = 0V$	43						
Total Harmonic Distortion + Noise (THD+N)	$V_{OUT} = 2V_{PP}$ , $f = 1kHz$ , $A_V = 1$ , $R_L = 600\Omega$	0.018				%	TYP	
	$V_{OUT} = 2V_{PP}$ , $f = 1kHz$ , $A_V = 1$ , $R_L = 2k\Omega$	0.009						



**TYPICAL PERFORMANCE CHARACTERISTICS**

At  $T_A = +25^\circ\text{C}$ ,  $V_S = \pm 15\text{V}$ ,  $R_L = 2\text{k}\Omega$  connected to  $0\text{V}$ , unless otherwise noted.

Large Signal Step Response

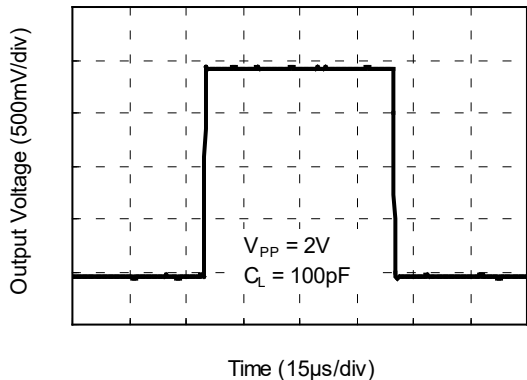

Small Signal Step Response

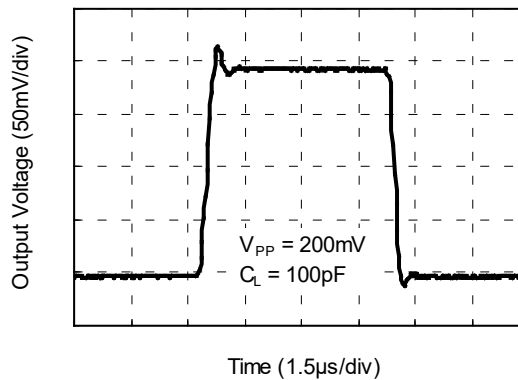

Gain and Phase vs. Frequency

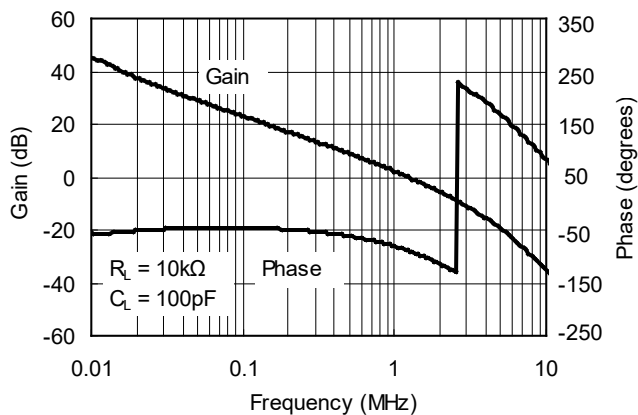

Input Voltage Noise Spectral Density vs. Frequency

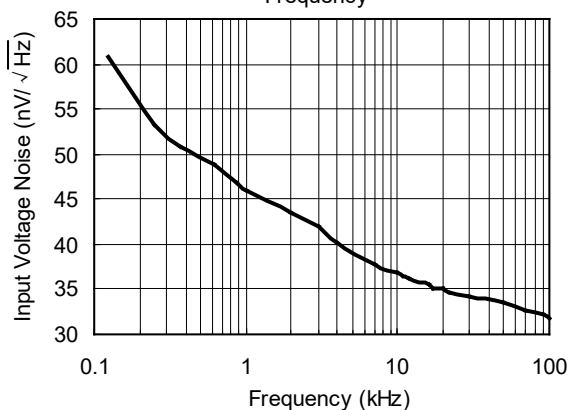

Negative Overload Recovery Time

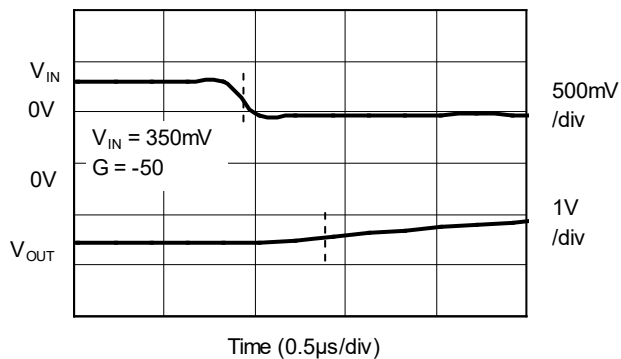

Positive Overload Recovery Time

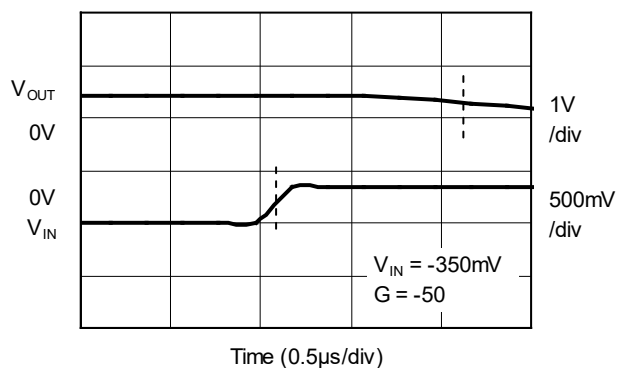

**TYPICAL PERFORMANCE CHARACTERISTICS (continued)**

At  $T_A = +25^\circ\text{C}$ ,  $V_S = \pm 15\text{V}$ ,  $R_L = 2\text{k}\Omega$  connected to  $0\text{V}$ , unless otherwise noted.

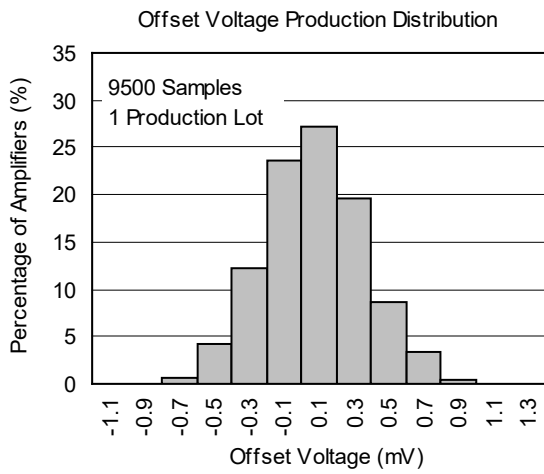

---

## **REVISION HISTORY**

NOTE: Page numbers for previous revisions may differ from page numbers in the current version.

<b>JANUARY 2017 – REV.A.1 to REV.A.2</b>	<b>Page</b>
Updated Absolute Maximum Ratings section.....	3

---

<b>JANUARY 2016 – REV.A to REV.A.1</b>	<b>Page</b>
Changed Electrical Characteristics section .....	6~8
Changed Package Outline Dimensions section .....	15~16
Changed Features section.....	1

---

<b>Changes from Original (DECEMBER 2012) to REV.A</b>	<b>Page</b>
Changed from product preview to production data.....	All

---

PACKAGE OUTLINE DIMENSIONS

SOT-23-5

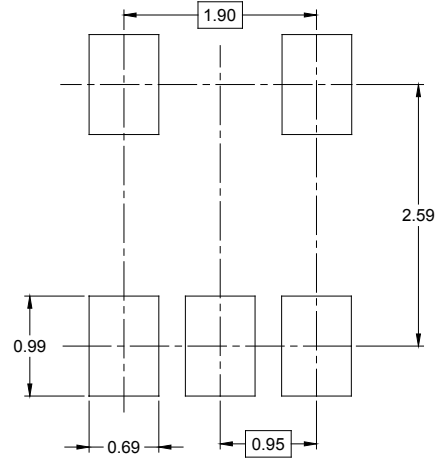
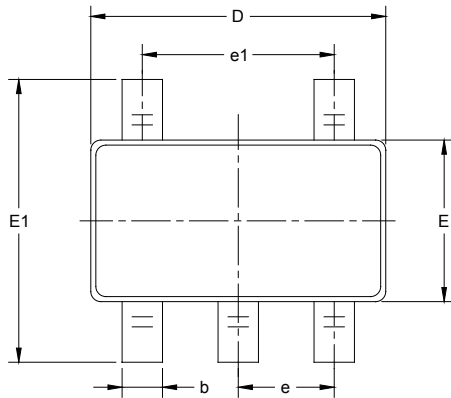

RECOMMENDED LAND PATTERN (Unit: mm)

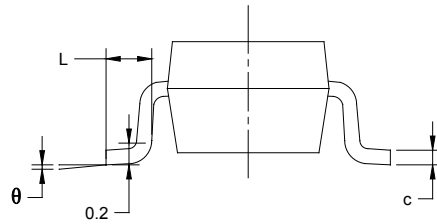
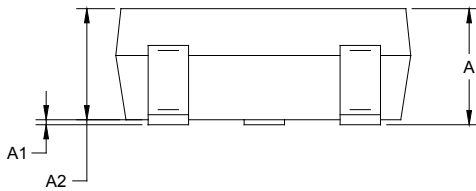

Symbol	Dimensions In Millimeters		Dimensions In Inches	
	MIN	MAX	MIN	MAX
A	1.050	1.250	0.041	0.049
A1	0.000	0.100	0.000	0.004
A2	1.050	1.150	0.041	0.045
b	0.300	0.500	0.012	0.020
c	0.100	0.200	0.004	0.008
D	2.820	3.020	0.111	0.119
E	1.500	1.700	0.059	0.067
E1	2.650	2.950	0.104	0.116
e	0.950 BSC		0.037 BSC	
e1	1.900 BSC		0.075 BSC	
L	0.300	0.600	0.012	0.024
$\theta$	0°	8°	0°	8°

PACKAGE OUTLINE DIMENSIONS

SOIC-8

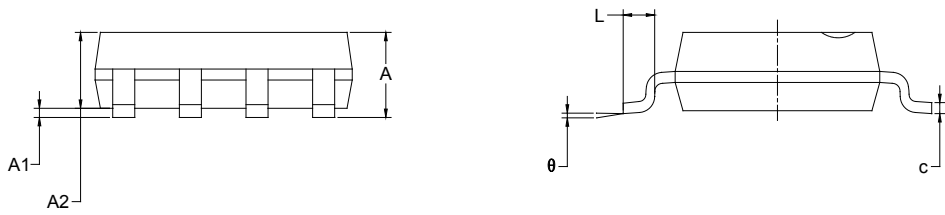
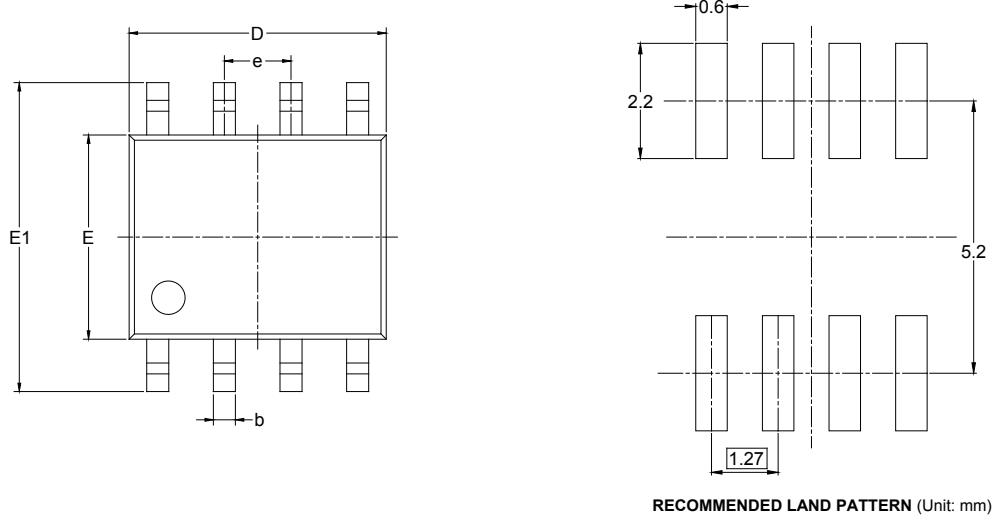

Symbol	Dimensions In Millimeters		Dimensions In Inches	
	MIN	MAX	MIN	MAX
A	1.350	1.750	0.053	0.069
A1	0.100	0.250	0.004	0.010
A2	1.350	1.550	0.053	0.061
b	0.330	0.510	0.013	0.020
c	0.170	0.250	0.006	0.010
D	4.700	5.100	0.185	0.200
E	3.800	4.000	0.150	0.157
E1	5.800	6.200	0.228	0.244
e	1.27 BSC		0.050 BSC	
L	0.400	1.270	0.016	0.050
θ	0°	8°	0°	8°

PACKAGE OUTLINE DIMENSIONS

MSOP-8

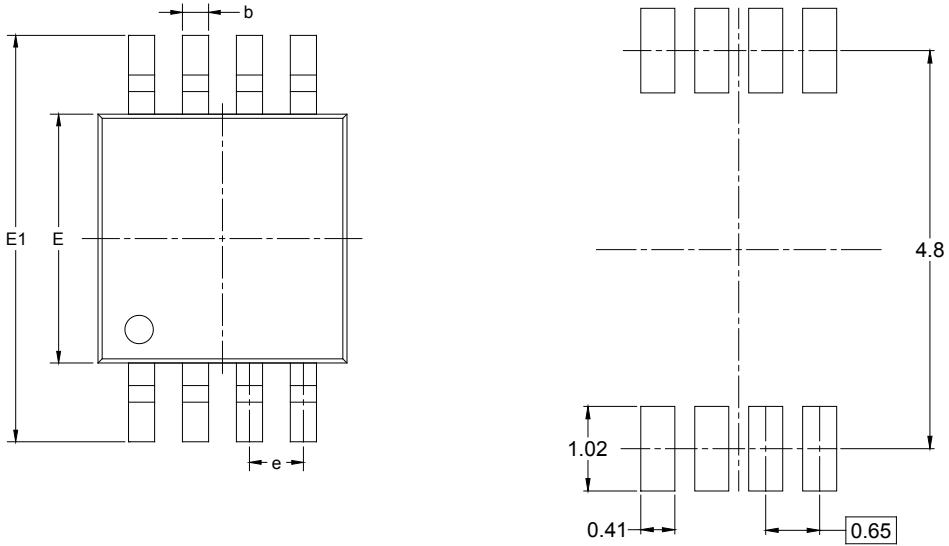

RECOMMENDED LAND PATTERN (Unit: mm)

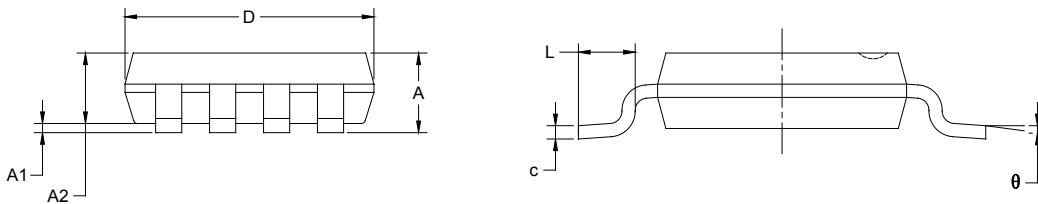

Symbol	Dimensions In Millimeters		Dimensions In Inches	
	MIN	MAX	MIN	MAX
A	0.820	1.100	0.032	0.043
A1	0.020	0.150	0.001	0.006
A2	0.750	0.950	0.030	0.037
b	0.250	0.380	0.010	0.015
c	0.090	0.230	0.004	0.009
D	2.900	3.100	0.114	0.122
E	2.900	3.100	0.114	0.122
E1	4.750	5.050	0.187	0.199
e	0.650 BSC		0.026 BSC	
L	0.400	0.800	0.016	0.031
θ	0°	6°	0°	6°

# PACKAGE INFORMATION

## PACKAGE OUTLINE DIMENSIONS

### SOIC-14

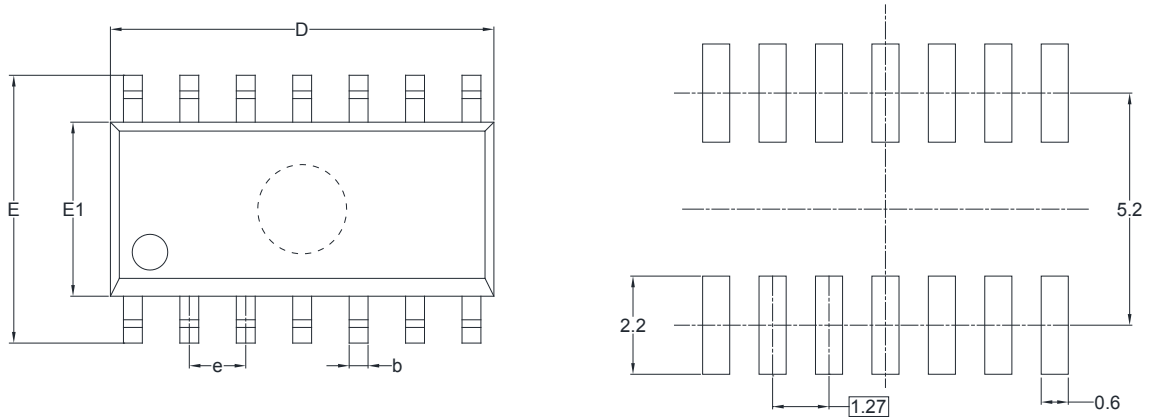

RECOMMENDED LAND PATTERN (Unit: mm)

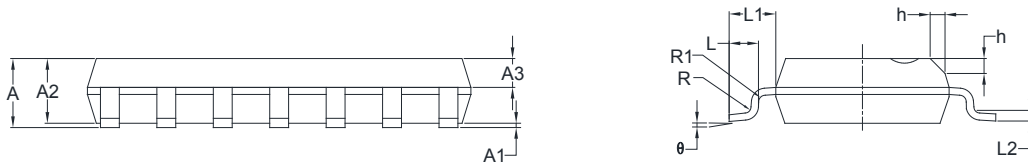

Symbol	Dimensions In Millimeters		Dimensions In Inches	
	MIN	MAX	MIN	MAX
A	1.35	1.75	0.053	0.069
A1	0.10	0.25	0.004	0.010
A2	1.25	1.65	0.049	0.065
A3	0.55	0.75	0.022	0.030
b	0.36	0.49	0.014	0.019
D	8.53	8.73	0.336	0.344
E	5.80	6.20	0.228	0.244
E1	3.80	4.00	0.150	0.157
e	1.27 BSC		0.050 BSC	
L	0.45	0.80	0.018	0.032
L1	1.04 REF		0.040 REF	
L2	0.25 BSC		0.01 BSC	
R	0.07		0.003	
R1	0.07		0.003	
h	0.30	0.50	0.012	0.020
θ	0°	8°	0°	8°

PACKAGE OUTLINE DIMENSIONS

TSSOP-14

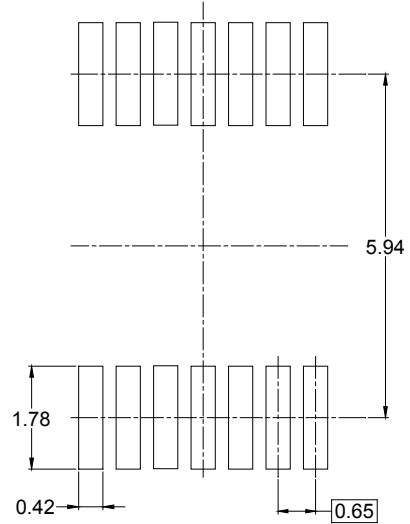
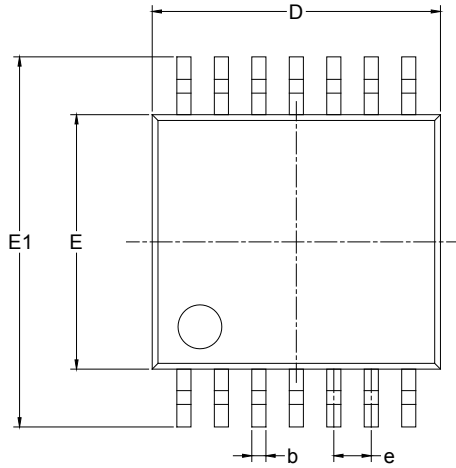

RECOMMENDED LAND PATTERN (Unit: mm)

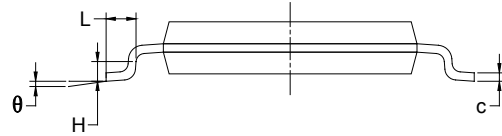
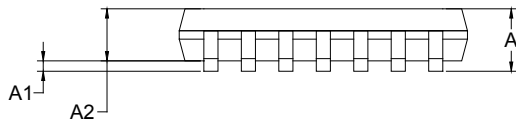

Symbol	Dimensions In Millimeters		Dimensions In Inches	
	MIN	MAX	MIN	MAX
A		1.200		0.047
A1	0.050	0.150	0.002	0.006
A2	0.800	1.050	0.031	0.041
b	0.190	0.300	0.007	0.012
c	0.090	0.200	0.004	0.008
D	4.860	5.100	0.191	0.201
E	4.300	4.500	0.169	0.177
E1	6.250	6.550	0.246	0.258
e	0.650 BSC		0.026 BSC	
L	0.500	0.700	0.02	0.028
H	0.25 TYP		0.01 TYP	
$\theta$	1°	7°	1°	7°



# PACKAGE INFORMATION

## TAPE AND REEL INFORMATION

### REEL DIMENSIONS

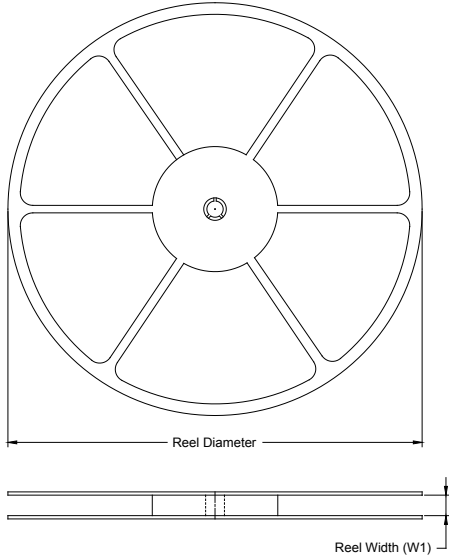

### TAPE DIMENSIONS

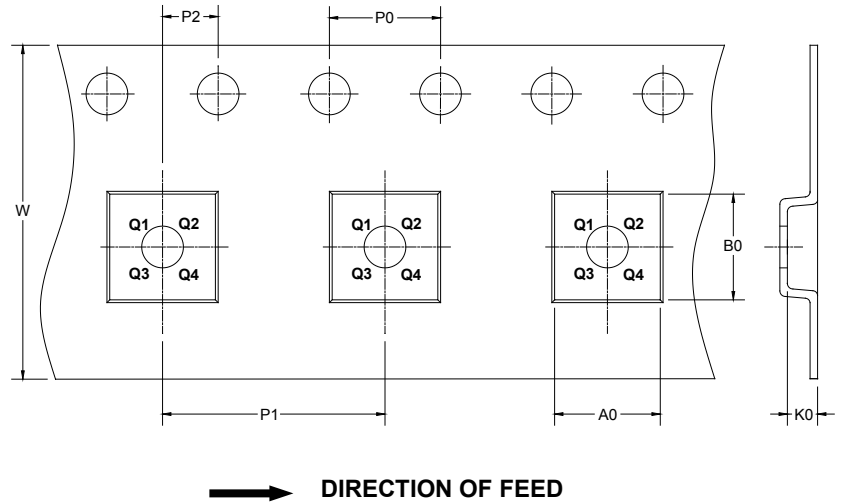

NOTE: The picture is only for reference. Please make the object as the standard.

### KEY PARAMETER LIST OF TAPE AND REEL

Package Type	Reel Diameter	Reel Width W1 (mm)	A0 (mm)	B0 (mm)	K0 (mm)	P0 (mm)	P1 (mm)	P2 (mm)	W (mm)	Pin1 Quadrant
SOT-23-5	7"	9.5	3.20	3.20	1.40	4.0	4.0	2.0	8.0	Q3
SOIC-8	13"	12.4	6.40	5.40	2.10	4.0	8.0	2.0	12.0	Q1
MSOP-8	13"	12.4	5.20	3.30	1.50	4.0	8.0	2.0	12.0	Q1
SOIC-14	13"	16.4	6.60	9.30	2.10	4.0	8.0	2.0	16.0	Q1
TSSOP-14	13"	12.4	6.95	5.60	1.20	4.0	8.0	2.0	12.0	Q1

D20001

# PACKAGE INFORMATION

## CARTON BOX DIMENSIONS



NOTE: The picture is only for reference. Please make the object as the standard.

## KEY PARAMETER LIST OF CARTON BOX

Reel Type	Length (mm)	Width (mm)	Height (mm)	Pizza/Carton
7" (Option)	368	227	224	8
7"	442	410	224	18
13"	386	280	370	5

DD0002