



SGM8416-1/SGM8416-2/SGM8416-4 24V, 800mA Peak Output Current Rail-to-Rail I/O Operational Amplifiers

GENERAL DESCRIPTION

The SGM8416-1(single), SGM8416-2 (dual) and SGM8416-4 (quad) are high slew rate, low power operational amplifiers optimized for high voltage systems. These devices can operate on single or dual power supply. They support rail-to-rail input and output operation.

The SGM8416-1/2/4 feature 10mV maximum offset voltage, 800mA peak output current, and 65V/ μ s high slew rate. The combination of characteristics makes them suitable for TFT-LCDs.

The SGM8416-1 is available in a Green TDFN-3 \times 3-8L package. The SGM8416-2 is available in a Green MSOP-8 (Exposed Pad) package. The SGM8416-4 is available in a Green TSSOP-14 (Exposed Pad) package. They are specified over the -40°C to +85°C temperature range.

FEATURES

- Rail-to-Rail Input and Output
- Supply Voltage Range: 4.5V to 26.5V
- Unity-Gain Stable
- High Slew Rate: 65V/ μ s
- Peak Output Current: 800mA
- -40°C to +85°C Operating Temperature Range
- Small Packaging:
 - SGM8416-1 Available in a Green TDFN-3 \times 3-8L Package
 - SGM8416-2 Available in a Green MSOP-8 (Exposed Pad) Package
 - SGM8416-4 Available in a Green TSSOP-14 (Exposed Pad) Package

APPLICATIONS

TFT-LCD Panels
LCD TVs
Monitors
Laptops

PACKAGE/ORDERING INFORMATION

MODEL	PACKAGE DESCRIPTION	SPECIFIED TEMPERATURE RANGE	ORDERING NUMBER	PACKAGE MARKING	PACKING OPTION
SGM8416-1	TDFN-3x3-8L	-40°C to +85°C	SGM8416-1YTDB8G/TR	SGM G69DB XXXXX	Tape and Reel, 4000
SGM8416-2	MSOP-8 (Exposed Pad)	-40°C to +85°C	SGM8416-2YPMS8G/TR	SGM84162 YPMS8 XXXXX	Tape and Reel, 4000
SGM8416-4	TSSOP-14 (Exposed Pad)	-40°C to +85°C	SGM8416-4YPTS14G/TR	SGM84164 YPTS14 XXXXX	Tape and Reel, 4000

MARKING INFORMATION

NOTE: XXXXX = Date Code and Vendor Code.

XXXXX

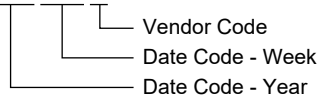

Green (RoHS & HSF): SG Micro Corp defines "Green" to mean Pb-Free (RoHS compatible) and free of halogen substances. If you have additional comments or questions, please contact your SGMICRO representative directly.

ABSOLUTE MAXIMUM RATINGS

Supply Voltage, (+V _S to -V _S)	-0.3V to 28V
Input/Output Voltage to -V _S	-0.3V to (+V _S) + 0.3V
+IN to -IN	±5V
Package Thermal Resistance	
TDFN-3x3-8L, θ _{JA}	84°C/W
MSOP-8 (Exposed Pad), θ _{JA}	82°C/W
TSSOP-14 (Exposed Pad), θ _{JA}	50°C/W
Junction Temperature	+150°C
Storage Temperature Range	-65°C to +150°C
Lead Temperature (Soldering, 10s)	+260°C
ESD Susceptibility	
HBM	8000V
MM	300V
CDM	1000V

RECOMMENDED OPERATING CONDITIONS

Supply Voltage Range	4.5V to 26.5V
Operating Temperature Range	-40°C to +85°C

OVERSTRESS CAUTION

Stresses beyond those listed in Absolute Maximum Ratings may cause permanent damage to the device. Exposure to absolute maximum rating conditions for extended periods may affect reliability. Functional operation of the device at any conditions beyond those indicated in the Recommended Operating Conditions section is not implied.

ESD SENSITIVITY CAUTION

This integrated circuit can be damaged if ESD protections are not considered carefully. SGMICRO recommends that all integrated circuits be handled with appropriate precautions. Failure to observe proper handling and installation procedures can cause damage. ESD damage can range from subtle performance degradation to complete device failure. Precision integrated circuits may be more susceptible to damage because even small parametric changes could cause the device not to meet the published specifications.

DISCLAIMER

SG Micro Corp reserves the right to make any change in circuit design, or specifications without prior notice.

PIN CONFIGURATIONS

FUNCTIONAL BLOCK DIAGRAMS

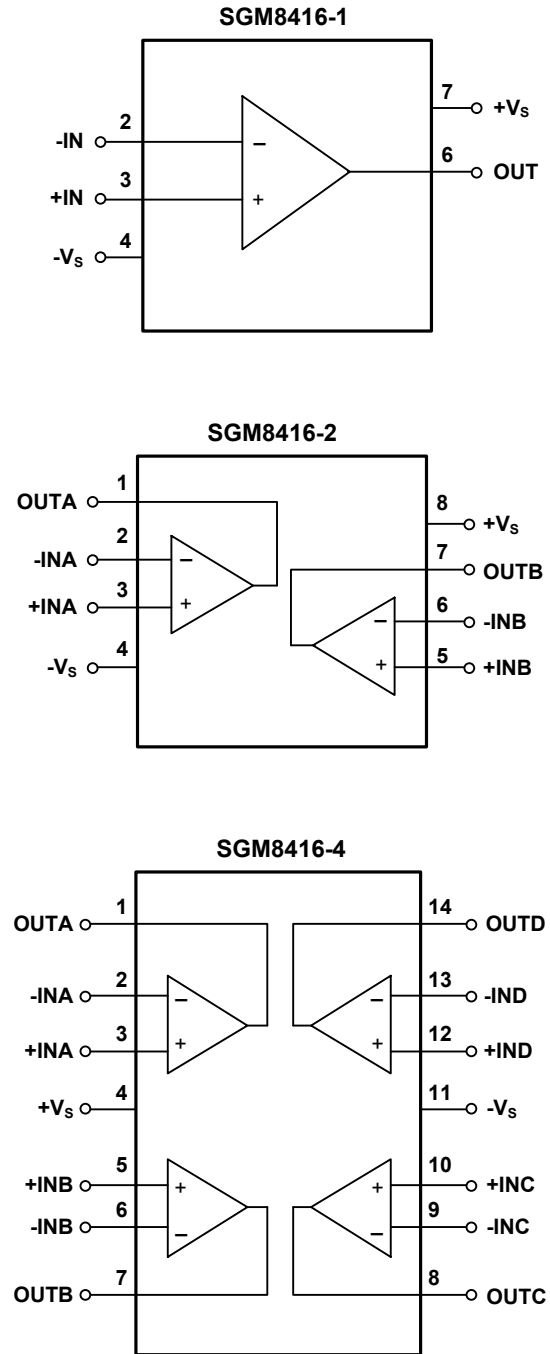
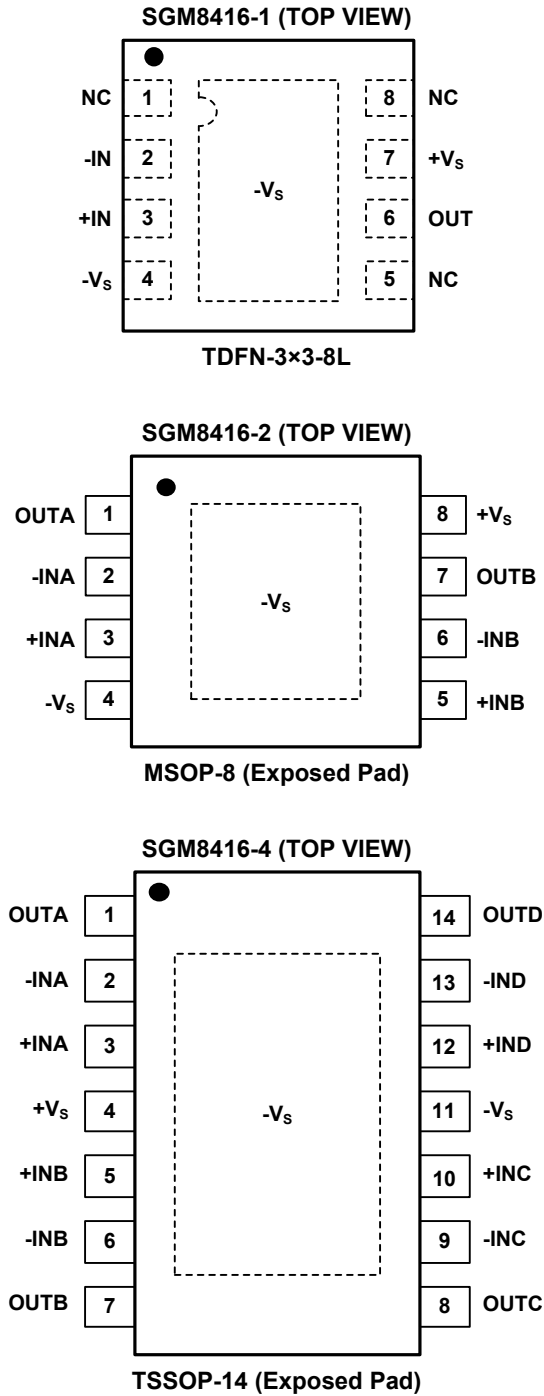

NOTE: For all packages, connect thermal die pad to $-V_s$.

ELECTRICAL CHARACTERISTICS

(+V_S = 16V, -V_S = 0V, +V_{IN} = V_{OUT} = +V_S/2, typical values are at T_A = +25°C, unless otherwise specified.)

PARAMETER	SYMBOL	CONDITIONS	MIN	TYP	MAX	UNITS
Input Characteristics						
Input Offset Voltage	V _{OS}	V _{CM} = +V _S /2		2	10	mV
Input Offset Voltage Drift	ΔV _{OS} /ΔT	V _{CM} = +V _S /2		3.6		μV/°C
Input Bias Current	I _B	V _{CM} = +V _S /2		1		nA
Load Regulation	ΔV _{LOAD}	I _{OUT} = 0mA to -80mA		0.01		mV/mA
		I _{OUT} = 0mA to 80mA		-0.01		
Input Common Mode Voltage Range	V _{CM}		-0.1		(+V _S) + 0.1	V
Common Mode Rejection Ratio	CMRR	-0.1V ≤ V _{CM} ≤ (+V _S) + 0.1V		72		dB
Open-Loop Voltage Gain	A _{OL}	0.5V ≤ V _{OUT} ≤ (+V _S) - 0.5V		120		dB
Output Characteristics						
Low Output Voltage Swing from Rail	V _{OL}	I _L = -50mA		0.26	0.34	V
High Output Voltage Swing from Rail	V _{OH}	I _L = 50mA	(+V _S) - 0.55	(+V _S) - 0.42		V
Transient Peak Output Current	I _{PK}			±800		mA
Continuous Output Current	I _{OUT}			±300		mA
Power Supply						
Supply Voltage Range			4.5		26.5	V
Power Supply Rejection Ratio	PSRR	+V _S = 4.5V to 26.5V, V _{CM} = 3V		94		dB
Quiescent Current/Amplifier	I _Q	No load		2.6		mA
Dynamic Performance						
Slew Rate	SR	4V step, C _L = 50pF, R _L = 10kΩ, 20% to 80%, A _V = 1		65		V/μs
Settling Time to ±0.1%	t _s	A _V = 1, V _{OUT} = 2V step, R _L = 10kΩ, C _L = 10pF		160		ns
-3dB Bandwidth	BW	R _L = 10kΩ, C _L = 10pF		50		MHz
Gain-Bandwidth Product	GBP	R _L = 10kΩ, C _L = 10pF		25		MHz
Phase Margin		R _L = 10kΩ, C _L = 10pF		30		°
Noise Performance						
Input Voltage Noise Density	e _n	f = 1kHz		115		nV/√Hz
Thermal Protection						
Thermal Shutdown Temperature	T _{SHDN}			150		°C
Thermal Shutdown Hysteresis	ΔT _{SHDN}			25		°C

TYPICAL PERFORMANCE CHARACTERISTICS

At $T_A = +25^\circ\text{C}$, $+V_S = 16\text{V}$, $-V_S = 0\text{V}$, unless otherwise specified.

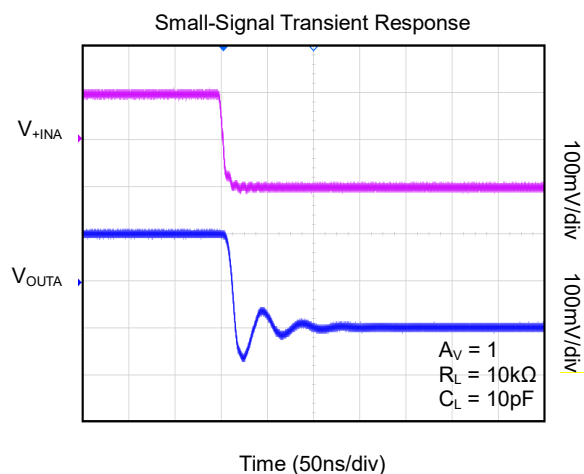
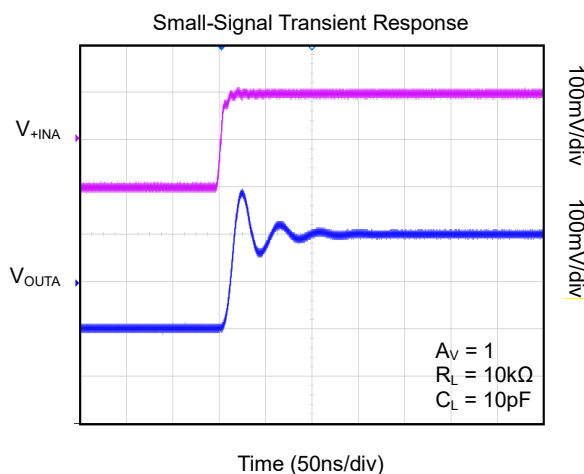
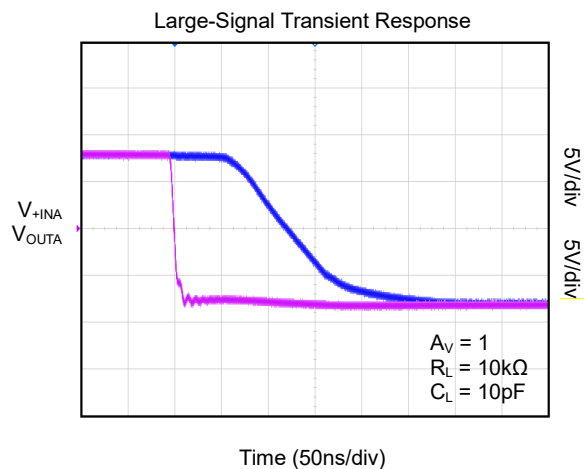
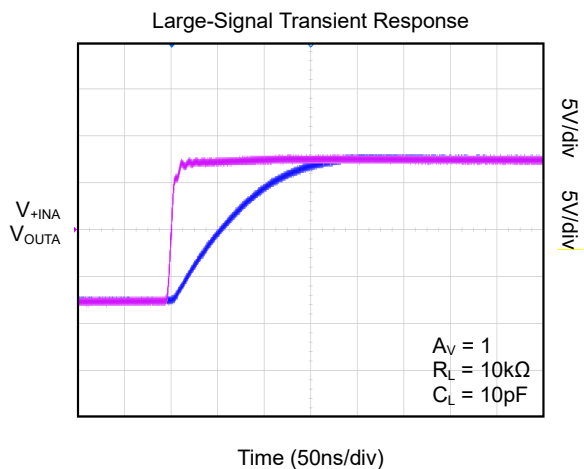

REVISION HISTORY

NOTE: Page numbers for previous revisions may differ from page numbers in the current version.

JULY 2021 – REV.A.1 to REV.A.2	Page
Added Output Current Limit section	6
Updated TSSOP-14 (Exposed Pad) package	10

JULY 2020 – REV.A to REV.A.1	Page
Updated TSSOP-14 (Exposed Pad) package	9
Updated Tape and Reel Information section	10

Changes from Original (MAY 2016) to REV.A	Page
Changed from product preview to production data	All

PACKAGE OUTLINE DIMENSIONS

TDFN-3x3-8L

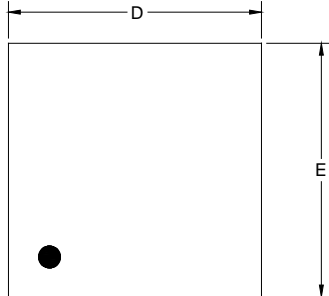

TOP VIEW

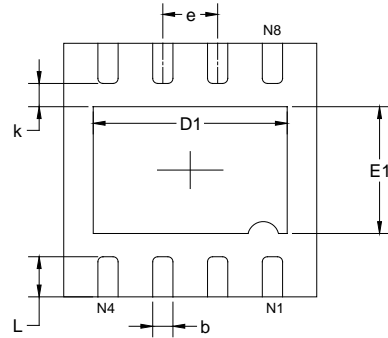

BOTTOM VIEW

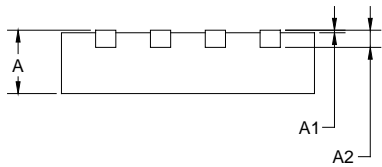

SIDE VIEW

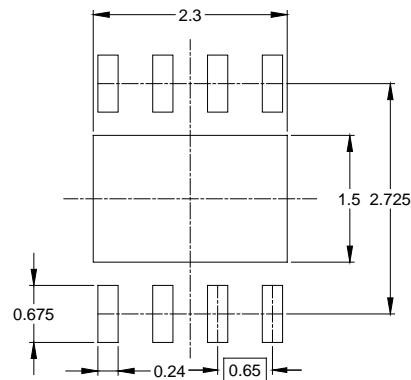

RECOMMENDED LAND PATTERN (Unit: mm)

Symbol	Dimensions In Millimeters		Dimensions In Inches	
	MIN	MAX	MIN	MAX
A	0.700	0.800	0.028	0.031
A1	0.000	0.050	0.000	0.002
A2	0.203 REF		0.008 REF	
D	2.900	3.100	0.114	0.122
D1	2.200	2.400	0.087	0.094
E	2.900	3.100	0.114	0.122
E1	1.400	1.600	0.055	0.063
k	0.200 MIN		0.008 MIN	
b	0.180	0.300	0.007	0.012
e	0.650 TYP		0.026 TYP	
L	0.375	0.575	0.015	0.023

NOTE: This drawing is subject to change without notice.

PACKAGE OUTLINE DIMENSIONS

MSOP-8 (Exposed Pad)

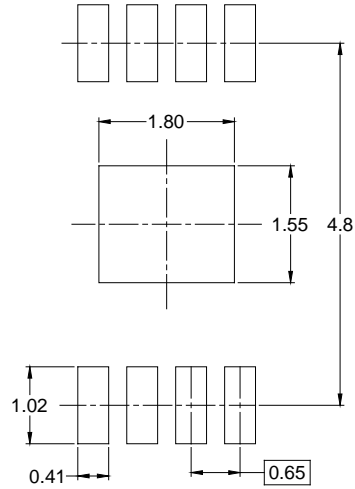
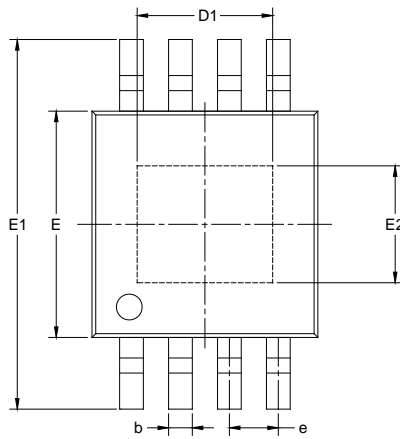

RECOMMENDED LAND PATTERN (Unit: mm)

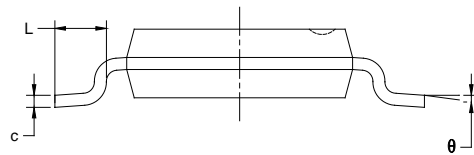
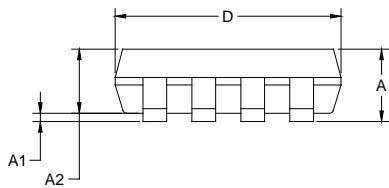

Symbol	Dimensions In Millimeters		Dimensions In Inches	
	MIN	MAX	MIN	MAX
A	0.820	1.100	0.032	0.043
A1	0.020	0.150	0.001	0.006
A2	0.750	0.950	0.030	0.037
b	0.250	0.380	0.010	0.015
c	0.090	0.230	0.004	0.009
D	2.900	3.100	0.114	0.122
D1	1.700	1.900	0.067	0.075
e	0.65 BSC		0.026 BSC	
E	2.900	3.100	0.114	0.122
E1	4.750	5.050	0.187	0.199
E2	1.450	1.650	0.057	0.065
L	0.400	0.800	0.016	0.031
θ	0°	6°	0°	6°

NOTES:

1. Body dimensions do not include mold flash or protrusion.
2. This drawing is subject to change without notice.

PACKAGE OUTLINE DIMENSIONS

TSSOP-14 (Exposed Pad)

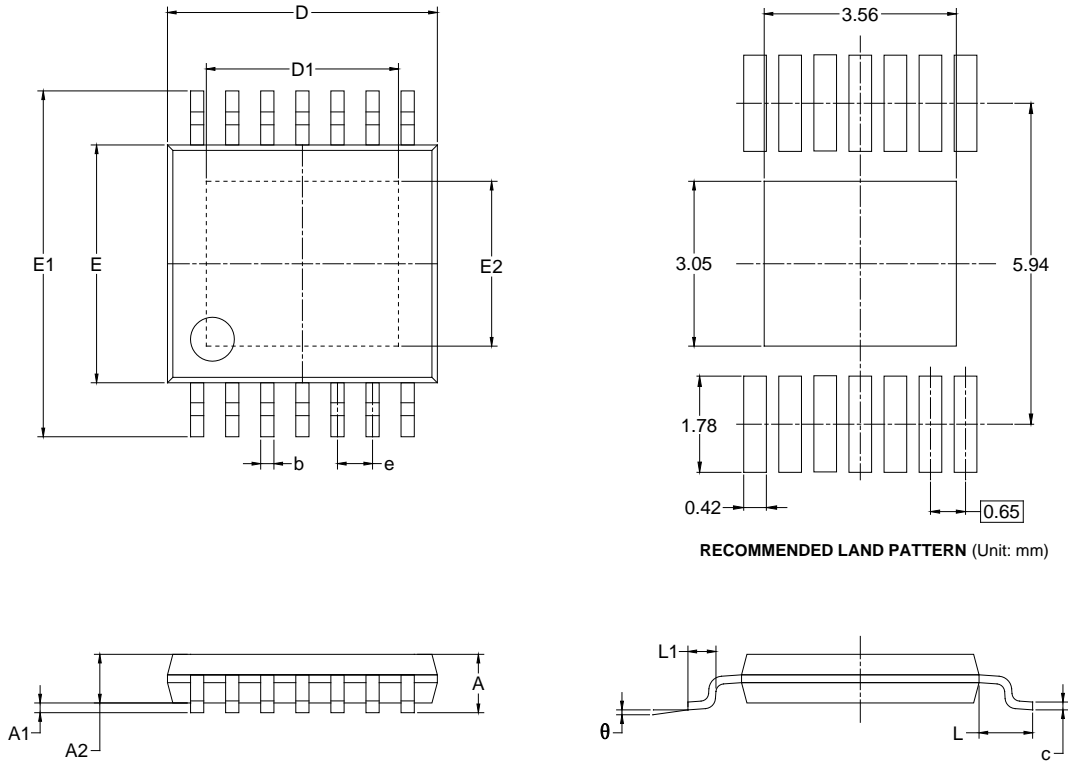

RECOMMENDED LAND PATTERN (Unit: mm)

Symbol	Dimensions In Millimeters		Dimensions In Inches	
	MIN	MAX	MIN	MAX
A		1.200		0.047
A1	0.050	0.150	0.002	0.006
A2	0.800	1.050	0.031	0.041
b	0.190	0.300	0.007	0.012
c	0.090	0.200	0.004	0.008
D	4.900	5.100	0.193	0.201
D1	3.300	3.660	0.130	0.144
E	4.300	4.500	0.169	0.177
E1	6.250	6.550	0.246	0.258
E2	2.900	3.150	0.114	0.124
e	0.650 BSC		0.026 BSC	
L		1.000		0.039
L1	0.450	0.750	0.018	0.030
θ	0°	8°	0°	8°

NOTES:

1. Body dimensions do not include mode flash or protrusion.
2. This drawing is subject to change without notice.

PACKAGE INFORMATION

TAPE AND REEL INFORMATION

REEL DIMENSIONS



TAPE DIMENSIONS



NOTE: The picture is only for reference. Please make the object as the standard.

KEY PARAMETER LIST OF TAPE AND REEL

Package Type	Reel Diameter	Reel Width W1 (mm)	A0 (mm)	B0 (mm)	K0 (mm)	P0 (mm)	P1 (mm)	P2 (mm)	W (mm)	Pin1 Quadrant
TDFN-3×3-8L	13"	12.4	3.35	3.35	1.13	4.0	8.0	2.0	12.0	Q1
MSOP-8 (Exposed Pad)	13"	12.4	5.20	3.30	1.50	4.0	8.0	2.0	12.0	Q1
TSSOP-14 (Exposed Pad)	13"	16.4	6.80	5.40	1.30	4.0	8.0	2.0	16.0	Q1

DD0001

PACKAGE INFORMATION

CARTON BOX DIMENSIONS



NOTE: The picture is only for reference. Please make the object as the standard.

KEY PARAMETER LIST OF CARTON BOX

Reel Type	Length (mm)	Width (mm)	Height (mm)	Pizza/Carton
13"	386	280	370	5

DD0002