

LBAW56LT1G

S-LBAW56LT1G

Monolithic Dual Switching Diode

1. FEATURES

- We declare that the material of product compliance with RoHS requirements and Halogen Free.
- S- prefix for automotive and other applications requiring unique site and control change requirements; AEC-Q101 qualified and PPAP capable.

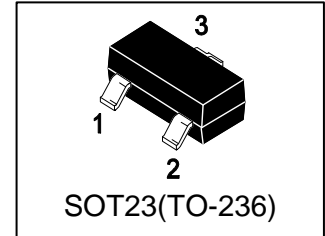

2. DEVICE MARKING AND ORDERING INFORMATION

Device	Marking	Shipping
LBAW56LT1G	A1	3000/Tape&Reel
LBAW56LT3G	A1	10000/Tape&Reel

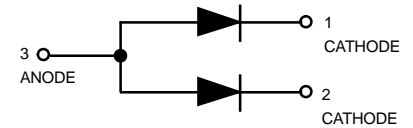

3. MAXIMUM RATINGS(Ta = 25°C)

Parameter	Symbol	Limits	Unit
Reverse Voltage	VR	70	V
Forward Current	IF	200	mA
Peak Forward Surge Current	IFM(surge)	500	mA

4. THERMAL CHARACTERISTICS

Parameter	Symbol	Limits	Unit
Total Device Dissipation, FR-5 Board (Note 1) @ TA = 25°C Derate above 25°C	PD	225 1.8	mW mW/°C
Thermal Resistance, Junction-to-Ambient	RθJA	556	°C/W
Total Device Dissipation, Alumina Substrate (Note 2) @ TA = 25°C Derate above 25°C	PD	300 2.4	mW mW/°C
Thermal Resistance, Junction-to-Ambient	RθJA	417	°C/W
Junction and Storage Temperature	TJ, Tstg	-55 ~ +150	°C

1. FR-5 = 1.0 x 0.75 x 0.062 in.

2. Alumina = 0.4 x 0.3 x 0.024 in. 99.5% alumina.

5. ELECTRICAL CHARACTERISTICS (Ta= 25°C)

Characteristic	Symbol	Min.	Typ.	Max.	Unit
Reverse Breakdown Voltage (I(BR)=100μA)	VBR	70	-	-	V
Forward Voltage (IF = 1.0 mA) (IF = 10 mA) (IF = 50 mA) (IF = 150 mA)	VF	-	-	715 855 1000 1250	mV
Reverse Voltage Leakage Current (VR = 70V) (VR = 70V, TJ = 150°C) (VR = 25V, TJ = 150°C)	IR	-	-	2.5 50 30	μA
Diode Capacitance (VR = 0V, f = 1.0 MHz)	CD	-	-	2.0	pF
Reverse Recovery Time (IF=IR = 10 mA, IR(REC) = 1.0 mA, RL = 100Ω)	trr	-	-	6.0	ns

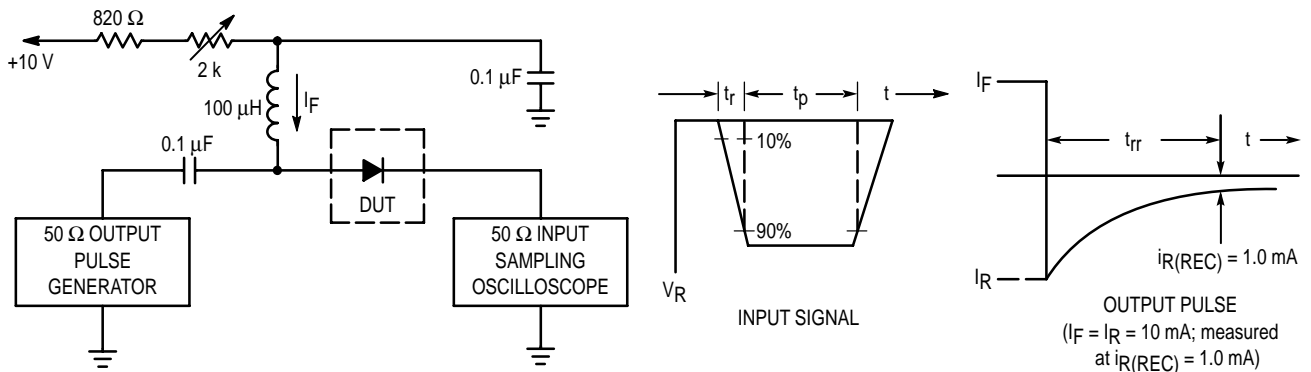

- Notes: 1. A 2.0 kΩ variable resistor adjusted for a Forward Current (IF) of 10 mA.
 2. Input pulse is adjusted so IR(peak) is equal to 10 mA.
 3. tp >> trr

Figure 1. Recovery Time Equivalent Test Circuit

6.ELECTRICAL CHARACTERISTICS CURVES

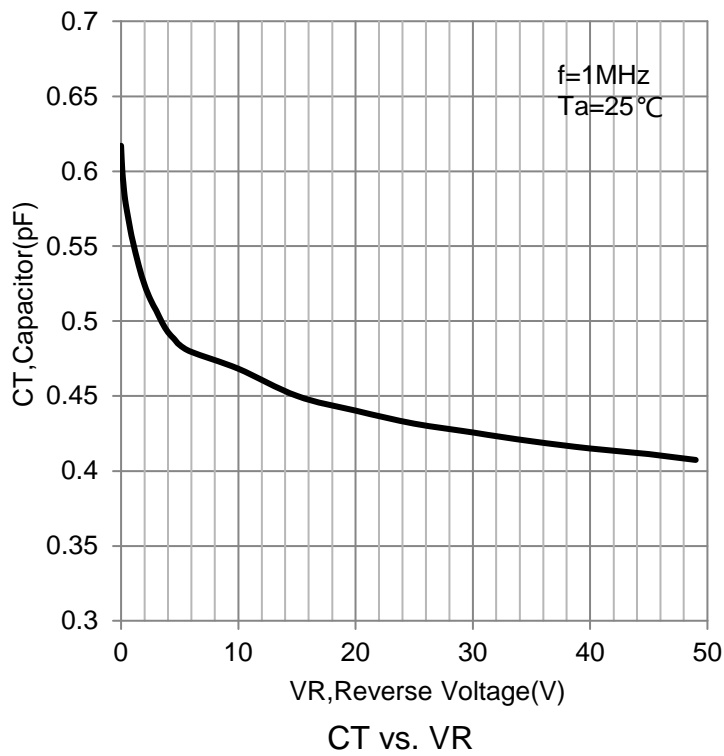
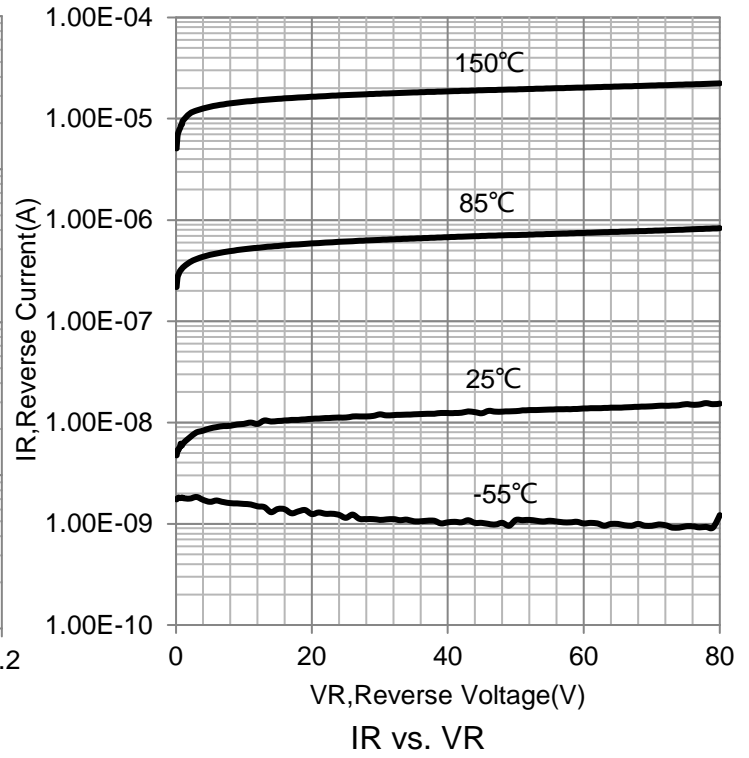
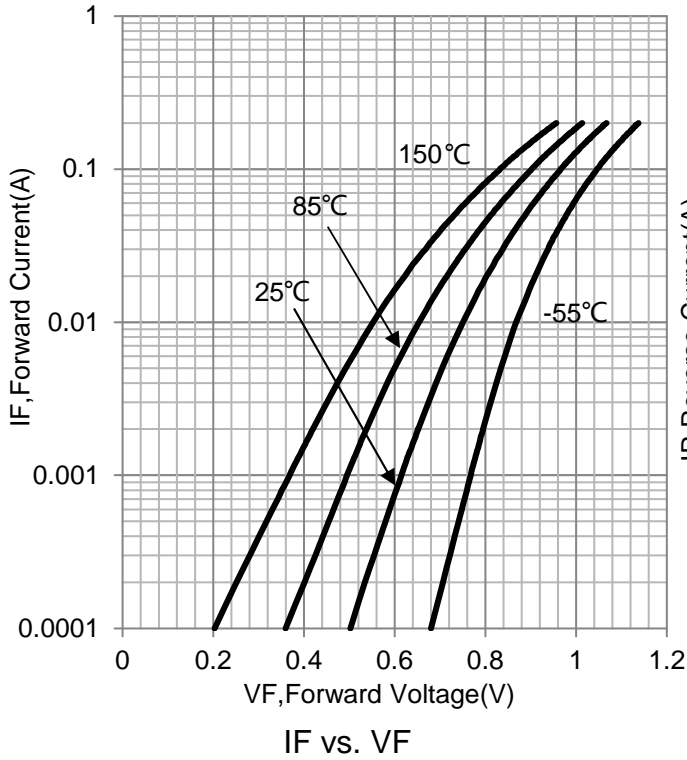

7. OUTLINE AND DIMENSIONS

Notes:

1. DIMENSIONING AND TOLERANCING PER ANSI Y14.5M, 1982.
2. CONTROLLING DIMENSION: MILLIMETERS.
3. MAXIMUM LEAD THICKNESS INCLUDES LEAD FINISH. MINIMUM LEAD THICKNESS IS THE MINIMUM THICKNESS OF BASE MATERIAL.
4. DIMENSIONS D AND E DO NOT INCLUDE MOLD FLASH, PROTRUSIONS OR GATE BURRS.

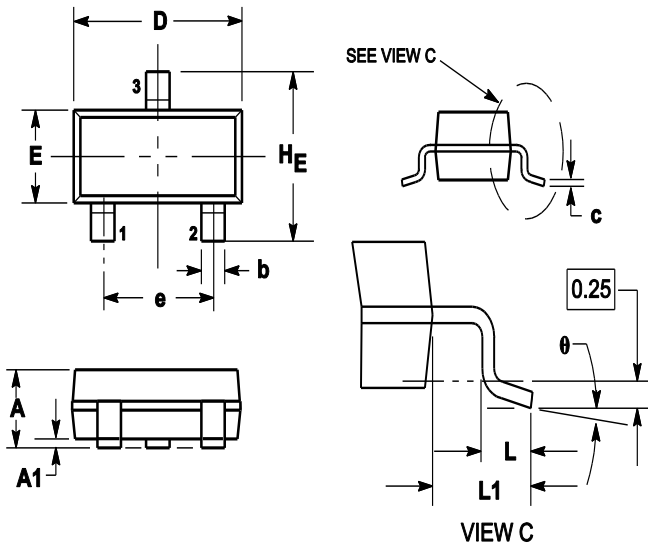

DIM	MILLIMETERS			INCHES		
	MIN	NOM	MAX	MIN	NOM	MAX
A	0.89	1	1.11	0.035	0.04	0.044
A1	0.01	0.06	0.1	0.001	0.002	0.004
b	0.37	0.44	0.5	0.015	0.018	0.02
c	0.09	0.13	0.18	0.003	0.005	0.007
D	2.80	2.9	3.04	0.11	0.114	0.12
E	1.20	1.3	1.4	0.047	0.051	0.055
e	1.78	1.9	2.04	0.07	0.075	0.081
L	0.10	0.2	0.3	0.004	0.008	0.012
L1	0.35	0.54	0.69	0.014	0.021	0.029
HE	2.10	2.4	2.64	0.083	0.094	0.104
theta	0°	---	10°	0°	---	10°

8. SOLDERING FOOTPRINT

