

LBSS123LT1G

S-LBSS123LT1G

N-CHANNEL POWER MOSFET

1. FEATURES

- We declare that the material of product compliance with RoHS requirements and Halogen Free.
- S- prefix for automotive and other applications requiring unique site and control change requirements; AEC-Q101 qualified and PPAP capable.

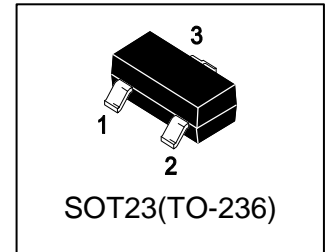

2. DEVICE MARKING AND ORDERING INFORMATION

Device	Marking	Shipping
LBSS123LT1G	SA	3000/Tape&Reel
LBSS123LT3G	SA	10000/Tape&Reel

3. MAXIMUM RATINGS(Ta = 25°C)

Parameter	Symbol	Limits	Unit
Drain–Source Voltage	VDSS	100	V
Gate–to–Source Voltage			
– Continuous	VGS	±20	V
– Non–repetitive (tp ≤ 50 μs)	VGSM	±40	
Drain Current			A
– Continuous (Note 1)	ID	0.17	
– Pulsed (Note 2)	IDM	0.68	

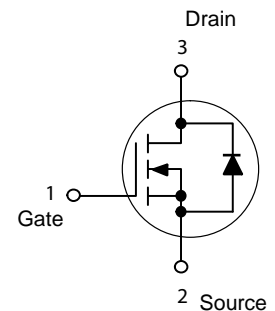

4. THERMAL CHARACTERISTICS

Parameter	Symbol	Limits	Unit
Total Device Dissipation, FR-5 Board (Note 3) @ TA = 25°C	PD	225	mW
Derate above 25°C		1.8	mW/°C
Thermal Resistance, Junction–to–Ambient	ROJA	556	°C/W
Junction and Storage temperature	TJ, Tstg	–55~+150	°C

1. The Power Dissipation of the package may result in a lower continuous drain current.
2. Pulse Width ≤ 300 μs, Duty Cycle ≤ 2.0%.
3. FR-5 = 1.0×0.75×0.062 in.

5. ELECTRICAL CHARACTERISTICS (Ta= 25°C)
OFF CHARACTERISTICS

Characteristic	Symbol	Min.	Typ.	Max.	Unit
Drain–Source Breakdown Voltage (VGS = 0, ID = 250μA)	VBRDSS	100	-	-	V
Zero Gate Voltage Drain Current (VGS = 0, VDS = 100 V, Tj=25°C)	IDSS	-	-	1	μA
(VGS = 0, VDS = 100 V, Tj=125°C)		-	-	60	
Gate–Body Leakage Current (VGS = 20 V, VDS = 0)	IGSS	-	-	50	nA

ON CHARACTERISTICS (Note 4)

Gate Threshold Voltage (VDS = VGS, ID = 1.0mA)	VGS(th)	0.8	-	2.0	V
Static Drain–Source On–State Resistance (VGS = 10 V, ID = 100 mA)	RDS(on)	-	5	6	Ω
Forward Transconductance (VGS = 0V, ID = 100 mA)	gfs	0.8	-	-	S

DYNAMIC CHARACTERISTICS

Input Capacitance (VDS = 25 V, VGS = 0, f = 1.0 MHz)	Ciss	15	42.7	88	pF
Output Capacitance (VDS = 25 V, VGS = 0, f = 1.0 MHz)	Coss	5	14	29.5	pF
Reverse Transfer Capacitance (VDS = 25 V, VGS = 0, f = 1.0 MHz)	Crss	1	3	6.3	pF
Total Gate Charge (VDS = 10 V, VGS = 10V, ID=0.22A)	Qg	2.3	6.32	13.3	nC
Gate-Source Charge (VDS = 10 V, VGS = 10V, ID=0.22A)	Qgs	0.55	1.55	3.3	nC
Gate-Drain Charge (VDS = 10 V, VGS = 10V, ID=0.22A)	Qgd	0.25	0.68	1.43	nC

SWITCHING CHARACTERISTICS (Note 4)

Turn-On Delay Time	(VCC = 30 V, IC = 0.28 A, VGS = 10 V, RGS = 50 Ω)	td(on)	-	20	-	ns
Turn-Off Delay Time		td(off)	-	40	-	

REVERSE DIODE

Diode Forward On–Voltage (ID = 0.34 A, VGS = 0 V)	VSD	-	-	1.3	V
--	-----	---	---	-----	---

4. Pulse Width ≤ 300 μs, Duty Cycle ≤ 2.0%.

6.ELECTRICAL CHARACTERISTICS CURVES

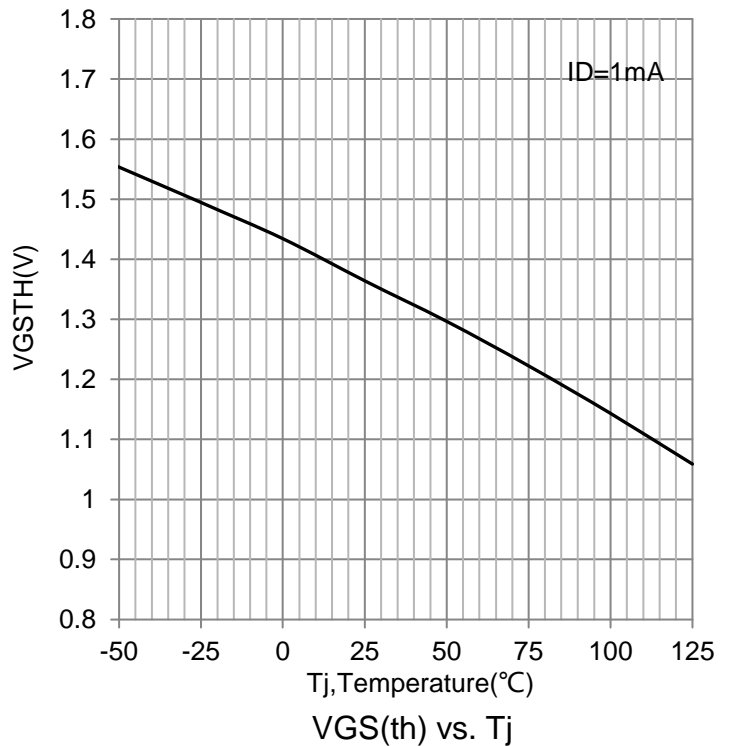
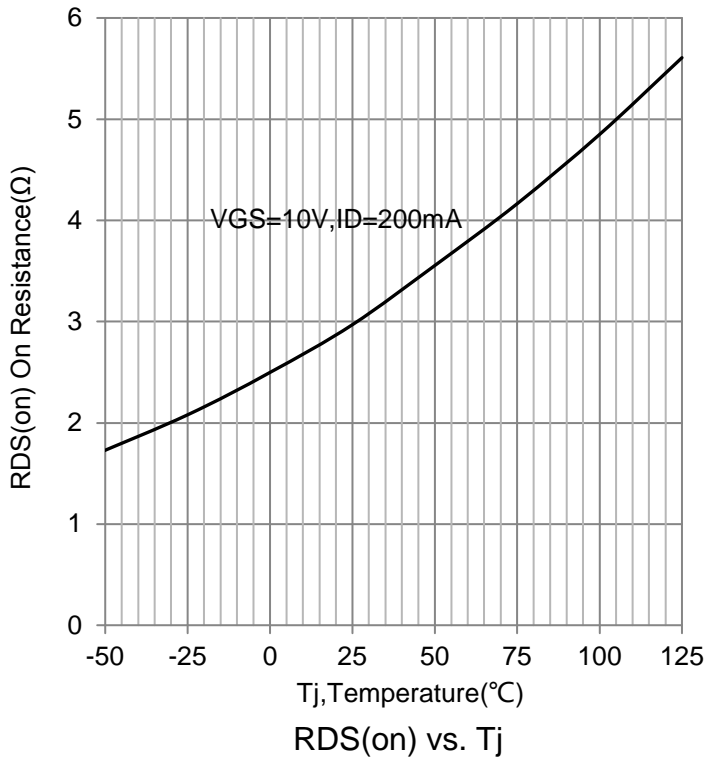
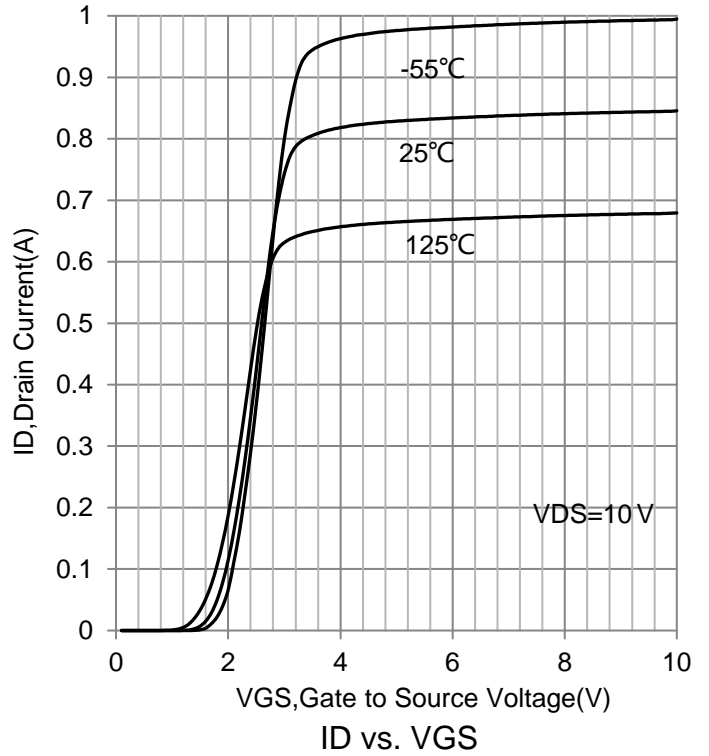
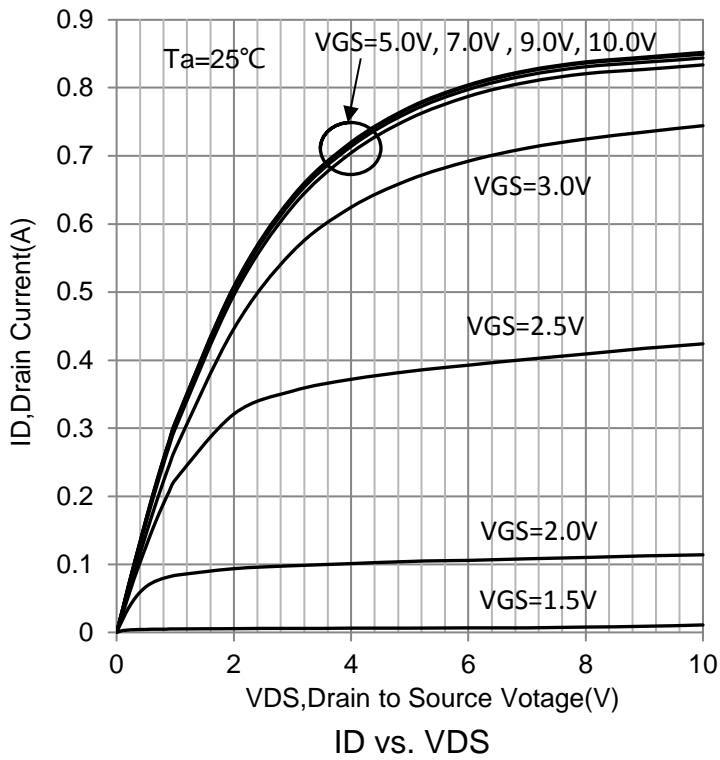

7. OUTLINE AND DIMENSIONS

Notes:

1. DIMENSIONING AND TOLERANCING PER ANSI Y14.5M, 1982.
2. CONTROLLING DIMENSION: MILLIMETERS.
3. MAXIMUM LEAD THICKNESS INCLUDES LEAD FINISH. MINIMUM LEAD THICKNESS IS THE MINIMUM THICKNESS OF BASE MATERIAL.
4. DIMENSIONS D AND E DO NOT INCLUDE MOLD FLASH, PROTRUSIONS OR GATE BURRS.

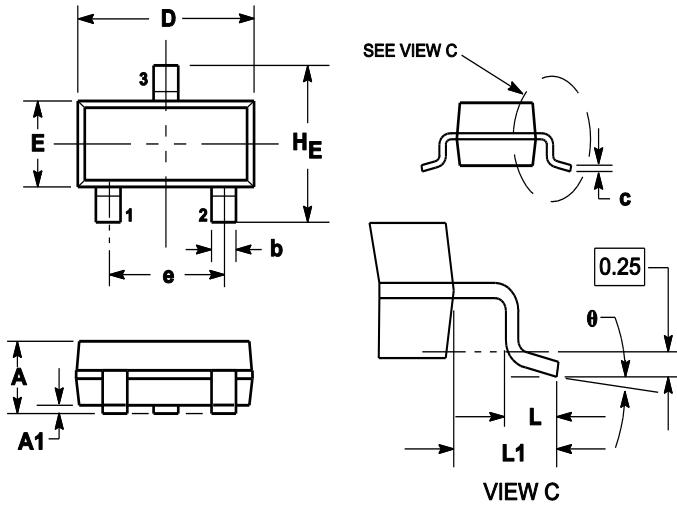

DIM	MILLIMETERS			INCHES		
	MIN	NOM	MAX	MIN	NOM	MAX
A	0.89	1	1.11	0.035	0.04	0.044
A1	0.01	0.06	0.1	0.001	0.002	0.004
b	0.37	0.44	0.5	0.015	0.018	0.02
c	0.09	0.13	0.18	0.003	0.005	0.007
D	2.80	2.9	3.04	0.11	0.114	0.12
E	1.20	1.3	1.4	0.047	0.051	0.055
e	1.78	1.9	2.04	0.07	0.075	0.081
L	0.10	0.2	0.3	0.004	0.008	0.012
L1	0.35	0.54	0.69	0.014	0.021	0.029
H _E	2.10	2.4	2.64	0.083	0.094	0.104
θ	0°	---	10°	0°	---	10°

8. SOLDERING FOOTPRINT

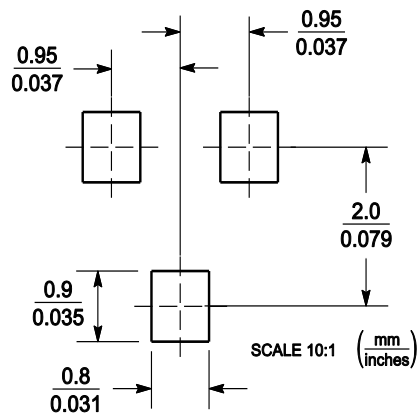

DISCLAIMER

- Curve guarantee in the specification. The curve of test items with electric parameter is used as quality guarantee. The curve of test items without electric parameter is used as reference only.
- Before you use our Products for new Project, you are requested to carefully read this document and fully understand its contents. LRC shall not be in any way responsible or liable for failure, malfunction or accident arising from the use of any LRC's Products against warning, caution or note contained in this document.
- All information contained in this document is current as of the issuing date and subject to change without any prior notice. Before purchasing or using LRC's Products, please confirm the latest information with a LRC sales representative.