

Features

- Transient protection for high-speed data lines
 - IEC 61000-4-2 (ESD) $\pm 30\text{kV}$ (Air)
 - $\pm 30\text{kV}$ (Contact)
 - IEC 61000-4-4 (EFT) 40A (5/50 ns)
 - Cable Discharge Event (CDE)
- Package optimized for high-speed lines
- Ultra-small package (1.0mm×0.6mm×0.55mm)
- Protects one data, control or power line
- Low capacitance: 12pF (Typical)
- Low leakage current: 0.01 μA @ V_{RWM} (Typical)
- Low clamping voltage
- Each I/O pin can withstand over 1000 ESD strikes for $\pm 8\text{kV}$ contact discharge

Description

SYT01M05DWC is a low-capacitance Transient Voltage Suppressor (TVS) designed to provide electrostatic discharge (ESD) protection for data, control or power lines. With typical capacitance of 12pF only, SYT01M05DWC is designed to protect parasitic-sensitive systems against over-voltage and over-current transient events. It complies with IEC 61000-4-2 (ESD), Level 4 ($\pm 15\text{kV}$ air, $\pm 8\text{kV}$ contact discharge), IEC 61000-4-4 (electrical fast transient - EFT) (40A, 5/50 ns), very fast charged device model (CDM) ESD and cable discharge event (CDE), etc.

SYT01M05DWC uses ultra-small uDFN-2L package. Each SYT01M05DWC device can protect one data line. It offers system designers flexibility to protect single data line where space is a premium concern.

Applications

- Portable Electronics
- Desktops, Servers and Notebooks
- Cellular Phones
- MP3 Ports
- Digital Camera Ports
- Subscriber Identity Module (SIM) card

Mechanical Characteristics

- DFN1.0x0.6-2 package
- Flammability Rating: UL 94V-0
- Marking: Part number, date code
- Packaging: Tape and Reel

Circuit Diagram



Pin Configuration

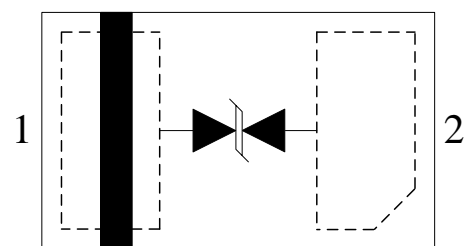

uDFN-2L
(Top View)

Absolute Maximum Rating

Symbol	Parameter	Value	Units
I_{PP}	Peak Pulse Current (8/20 μ s)	4	A
P_{PK}	Peak Pulse Power (8/20 μ s)	50	Watts
V_{ESD}	ESD per IEC 61000-4-2 (Air) ESD per IEC 61000-4-2 (Contact)	± 30 ± 30	kV
T_{OPT}	Operating Temperature	-55/+125	$^{\circ}$ C
T_{STG}	Storage Temperature	-55/+150	$^{\circ}$ C

Electrical Characteristics (T = 25 $^{\circ}$ C)

Symbol	Parameter
V_{RWM}	Nominal Reverse Working Voltage
I_R	Reverse Leakage Current @ V_{RWM}
V_{BR}	Reverse Breakdown Voltage @ I_T
I_T	Test Current for Reverse Breakdown
V_C	Clamping Voltage @ I_{PP}
I_{PP}	Maximum Peak Pulse Current
C_{ESD}	Parasitic Capacitance
V_R	Reverse Voltage
f	Small Signal Frequency

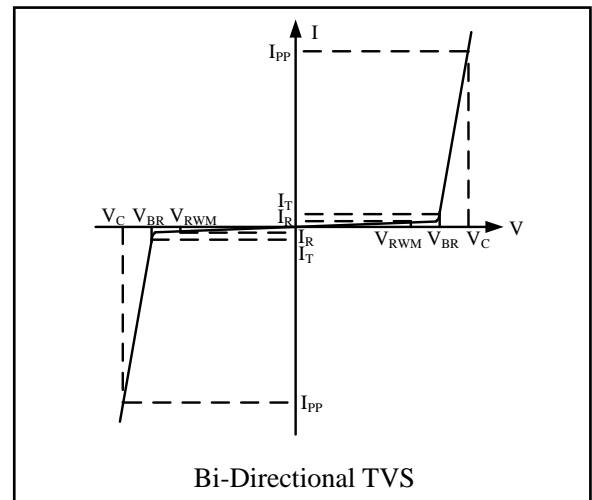

Symbol	Test Condition	Minimum	Typical	Maximum	Units
V_{RWM}				5.0	V
I_R	$V_{RWM} = 5V, T = 25^{\circ}C$ Between I/O_1 and I/O_2		0.01	1.0	μ A
V_{BR}	$I_T = 1mA$ Between I/O_1 and I/O_2	5.5	6.0		V
V_C	$I_{PP} = 1A, t_p = 8/20\mu s$ Between I/O_1 and I/O_2			10.0	V
V_C	$I_{PP} = 4A, t_p = 8/20\mu s$ Between I/O_1 and I/O_2			12.5	V
R_{DYN}	Dynamic Resistance		0.4		Ω
C_{ESD}	$V_R = 0V, f = 1MHz$ Between I/O_1 and I/O_2		12		pF

TLP Measurement of I/O_1 to I/O_2

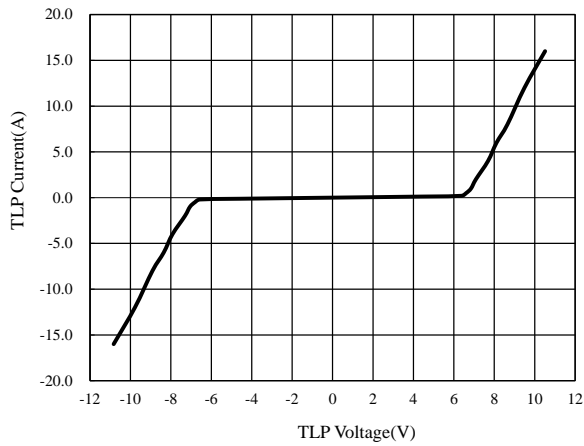

Voltage Sweeping of I/O_1 to I/O_2

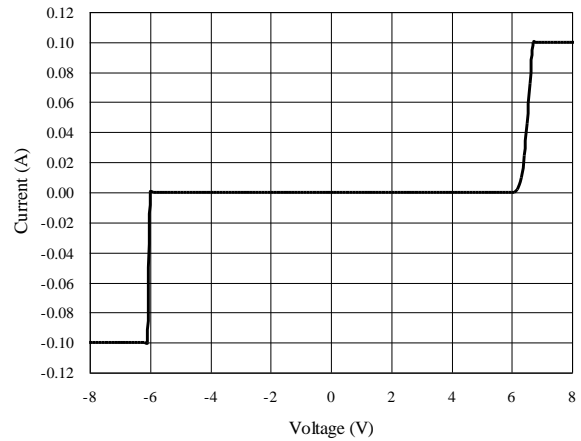

Capacitance vs. Voltage of I/O_1 to I/O_2 (f = 1MHz)

Capacitance vs. Reverse Voltage

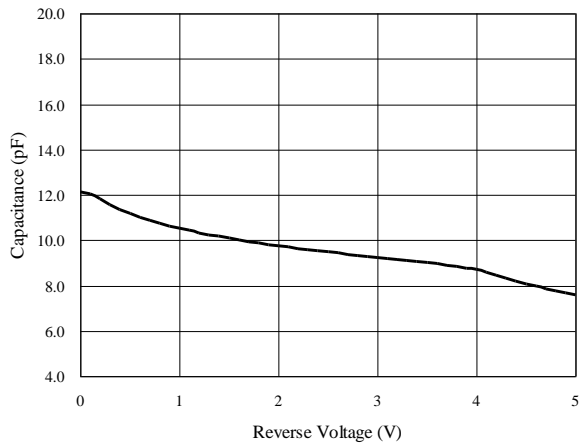

Normalized Capacitance vs. Reverse Voltage

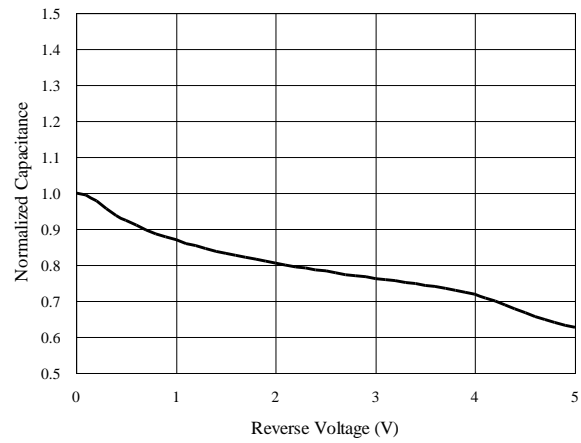

ESD Clamping of I/O_1 to I/O_2 (+8kV Contact per IEC 61000-4-2)

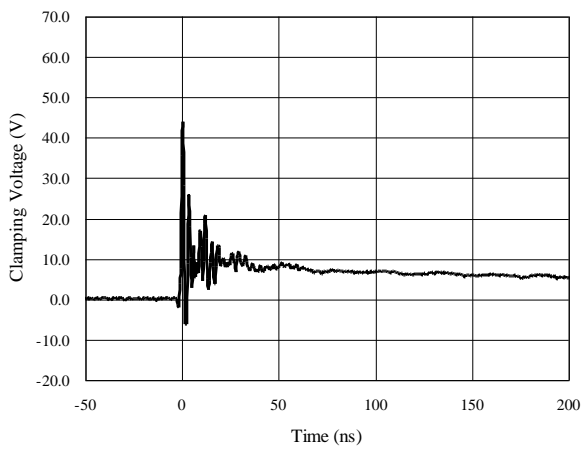

ESD Clamping of I/O_1 to I/O_2 (-8kV Contact per IEC 61000-4-2)

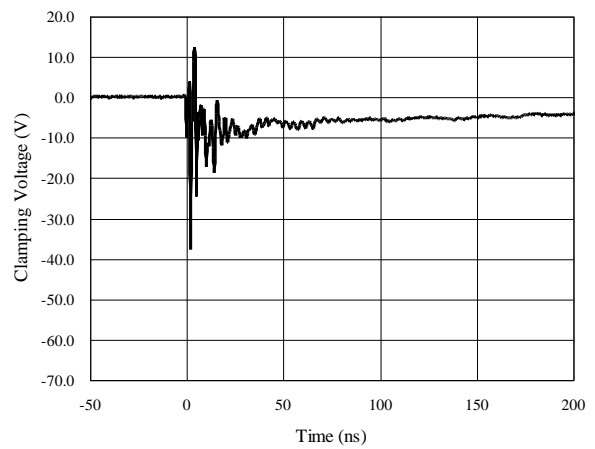

Package Outline

- uDFN-2L package
- 2 leads, very small package
- MSL-1

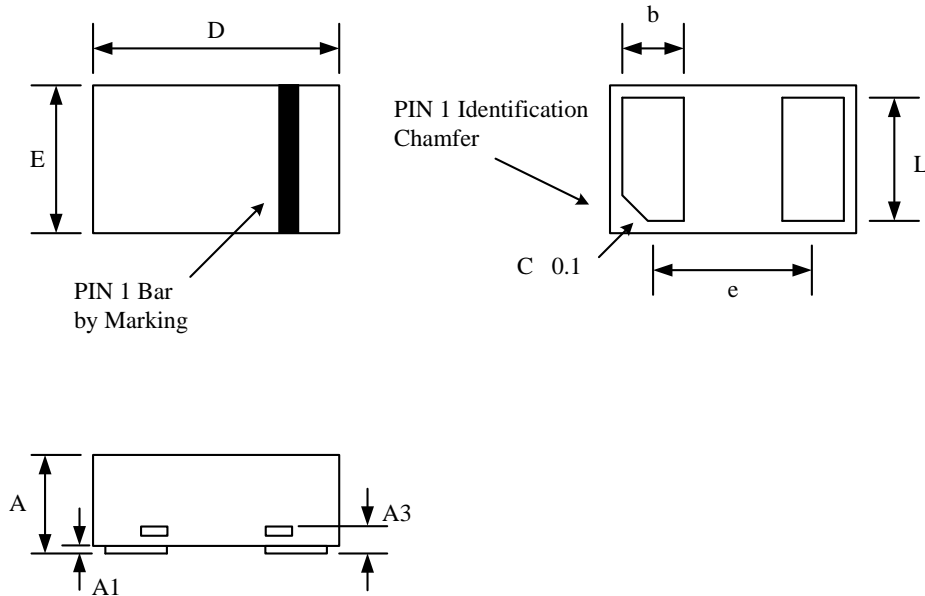

Package Dimensions (Controlling dimensions are in millimeters)

Symbol	Dimensions In Millimeters		Dimensions In Inches	
	Minimum	Maximum	Minimum	Maximum
A	0.400	0.550	0.016	0.022
A1	0.000	0.050	0.000	0.002
A3	0.125 REF		0.005 REF	
D	0.950	1.050	0.037	0.041
E	0.550	0.650	0.022	0.026
b	0.200	0.300	0.008	0.012
e	0.650 BSC		0.026 BSC	
L	0.450	0.550	0.018	0.022

Tape and Reel Specification

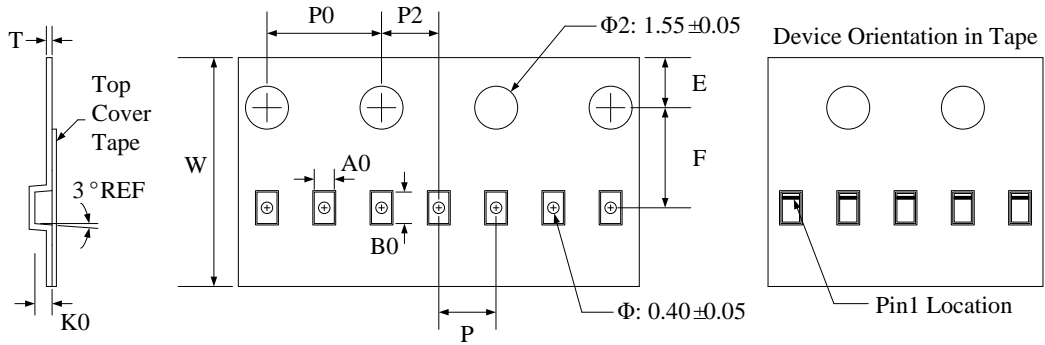

Symbol	W	A0	B0	K0	E	F	P	P0	P2	T
Dimensions (mm)	8.00±0.1	0.7±0.05	1.15±0.05	0.55±0.05	1.75±0.1	3.5±0.05	2.0±0.1	4.0±0.1	2.0±0.05	0.2±0.05

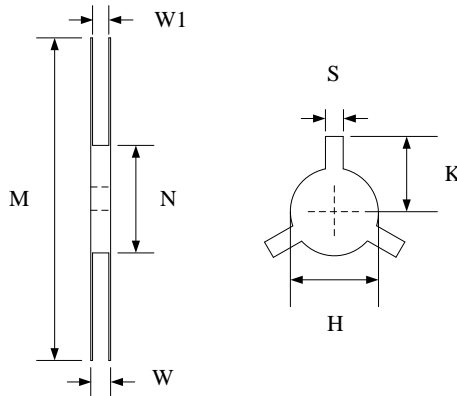
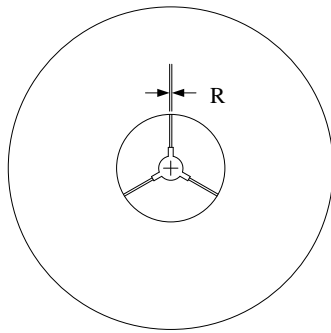

Symbol	Reel Size	M	N	W	W1	H	S	K	R
Dimensions (mm)	Φ178	178.0±1.0	60.0±1.0	11.5±0.5	9.0±0.5	13.0±0.5	2.0±0.1	11.0±0.2	1.0±0.05

Marking Codes



Note:

- (1) "F" is part number, fixed
- (2) "M" is date code, which is the assembly month in three years, changing as (1~9, 0, A~Z)

Ordering Information

Part Number	Working Voltage	Quantity Per Reel	Reel Size
SYT01M05DWC	5V	10,000	7 Inch

PCB Layout Pattern

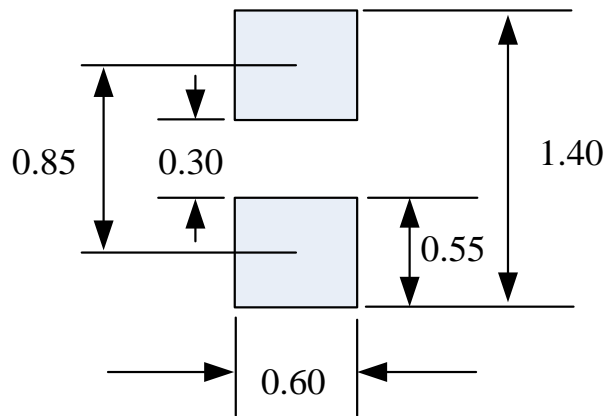

Notes: All dimension in millimeter



IMPORTANT NOTICE

- 1. Right to make changes.** Silergy and its subsidiaries (hereafter Silergy) reserve the right to change any information published in this document, including but not limited to circuitry, specification and/or product design, manufacturing or descriptions, at any time and without notice. This document supersedes and replaces all information supplied prior to the publication hereof. Buyers should obtain the latest relevant information before placing orders and should verify that such information is current and complete. All semiconductor products are sold subject to Silergy's standard terms and conditions of sale.
- 2. Applications.** Application examples that are described herein for any of these products are for illustrative purposes only. Silergy makes no representation or warranty that such applications will be suitable for the specified use without further testing or modification. Buyers are responsible for the design and operation of their applications and products using Silergy products. Silergy or its subsidiaries assume no liability for any application assistance or designs of customer products. It is customer's sole responsibility to determine whether the Silergy product is suitable and fit for the customer's applications and products planned. To minimize the risks associated with customer's products and applications, customer should provide adequate design and operating safeguards. Customer represents and agrees that it has all the necessary expertise to create and implement safeguards which anticipate dangerous consequences of failures, monitor failures and their consequences, lessen the likelihood of failures that might cause harm and take appropriate remedial actions. Silergy assumes no liability related to any default, damage, costs or problem in the customer's applications or products, or the application or use by customer's third-party buyers. Customer will fully indemnify Silergy, its subsidiaries, and their representatives against any damages arising out of the use of any Silergy components in safety-critical applications. It is also buyers' sole responsibility to warrant and guarantee that any intellectual property rights of a third party are not infringed upon when integrating Silergy products into any application. Silergy assumes no responsibility for any said applications or for any use of any circuitry other than circuitry entirely embodied in a Silergy product.
- 3. Limited warranty and liability.** Information furnished by Silergy in this document is believed to be accurate and reliable. However, Silergy makes no representation or warranty, expressed or implied, as to the accuracy or completeness of such information and shall have no liability for the consequences of use of such information. In no event shall Silergy be liable for any indirect, incidental, punitive, special or consequential damages, including but not limited to lost profits, lost savings, business interruption, costs related to the removal or replacement of any products or rework charges, whether or not such damages are based on tort or negligence, warranty, breach of contract or any other legal theory. Notwithstanding any damages that customer might incur for any reason whatsoever, Silergy' aggregate and cumulative liability towards customer for the products described herein shall be limited in accordance with the Standard Terms and Conditions of Sale of Silergy.
- 4. Suitability for use.** Customer acknowledges and agrees that it is solely responsible for compliance with all legal, regulatory and safety-related requirements concerning its products, and any use of Silergy components in its applications, notwithstanding any applications-related information or support that may be provided by Silergy. Silergy products are not designed, authorized or warranted to be suitable for use in life support, life-critical or safety-critical systems or equipment, nor in applications where failure or malfunction of an Silergy product can reasonably be expected to result in personal injury, death or severe property or environmental damage. Silergy assumes no liability for inclusion and/or use of Silergy products in such equipment or applications and therefore such inclusion and/or use is at the customer's own risk.
- 5. Terms and conditions of commercial sale.** Silergy products are sold subject to the standard terms and conditions of commercial sale, as published at <http://www.silergy.com/stdterms>, unless otherwise agreed in a valid written individual agreement specifically agreed to in writing by an authorized officer of Silergy. In case an individual agreement is concluded only the terms and conditions of the respective agreement shall apply. Silergy hereby expressly objects to and denies the application of any customer's general terms and conditions with regard to the purchase of Silergy products by the customer.
- 6. No offer to sell or license.** Nothing in this document may be interpreted or construed as an offer to sell products that is open for acceptance or the grant, conveyance or implication of any license under any copyrights, patents or other industrial or intellectual property rights. Silergy makes no representation or warranty that any license, either express or implied, is granted under any patent right, copyright, mask work right, or other intellectual property right. Information published by Silergy regarding third-party products or services does not constitute a license to use such products or services or a warranty or endorsement thereof. Use of such information may require a license from a third party under the patents or other intellectual property of the third party, or a license from Silergy under the patents or other intellectual property of Silergy.

For more information, please visit: www.silergy.com

© 2018 Silergy Corp.

All Rights Reserved.