



## S2AF THRU S2MF Surface Mount Standard Rectifiers

**Reverse Voltage - 50 to 1000 V**

**Forward Current - 2 A**

### FEATURES

- For surface mounted applications
- Low profile package
- Glass Passivated Chip Junction
- Easy to pick and place
- Lead free in comply with EU RoHS 2011/65/EU directives

### MECHANICAL DATA

- Case: SMAF
- Terminals: Solderable per MIL-STD-750, Method 2026
- Approx. Weight: 27mg 0.00095oz

### PINNING

PIN	DESCRIPTION
1	Cathode
2	Anode

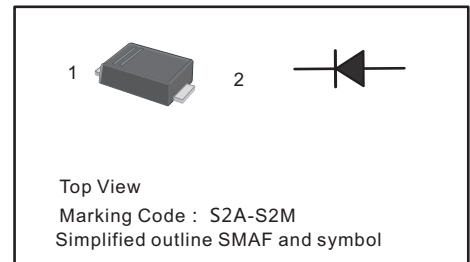

### Maximum Ratings and Electrical characteristics

Ratings at 25 °C ambient temperature unless otherwise specified.

Single phase half-wave 60 Hz, resistive or inductive load, for capacitive load current derate by 20 %.

Parameter	Symbols	S2AF	S2BF	S2DF	S2GF	S2JF	S2KF	S2MF	Units
Maximum Repetitive Peak Reverse Voltage	$V_{RRM}$	50	100	200	400	600	800	1000	V
Maximum RMS voltage	$V_{RMS}$	35	70	140	280	420	560	700	V
Maximum DC Blocking Voltage	$V_{DC}$	50	100	200	400	600	800	1000	V
Maximum Average Forward Rectified Current at $T_c = 125\text{ }^\circ\text{C}$	$I_{F(AV)}$	2							A
Peak Forward Surge Current 8.3 ms Single Half Sine Wave Superimposed on Rated Load	$I_{FSM}$	50							A
Maximum Instantaneous Forward Voltage at 2 A	$V_F$	1.1							V
Maximum DC Reverse Current $T_a = 25\text{ }^\circ\text{C}$ at Rated DC Blocking Voltage $T_a = 125\text{ }^\circ\text{C}$	$I_R$	5 100							$\mu\text{A}$
Typical Junction Capacitance <sup>(1)</sup>	$C_j$	22							pF
Typical Thermal Resistance <sup>(2)</sup>	$R_{\theta JA}$ $R_{\theta JC}$	65 20							$^\circ\text{C/W}$
Operating and Storage Temperature Range	$T_j, T_{stg}$	-55 ~ +150							$^\circ\text{C}$

1) Measured at 1 MHz and applied reverse voltage of 4 V D.C

2) P.C.B. mounted with 0.2 X 0.2" (5 X 5 mm) copper pad areas.



# S2AF THRU S2MF Surface Mount Standard Rectifiers

## Characteristic Curves ( $T_A=25\text{ }^\circ\text{C}$ unless otherwise noted)

Fig.1 Forward Current Derating Curve

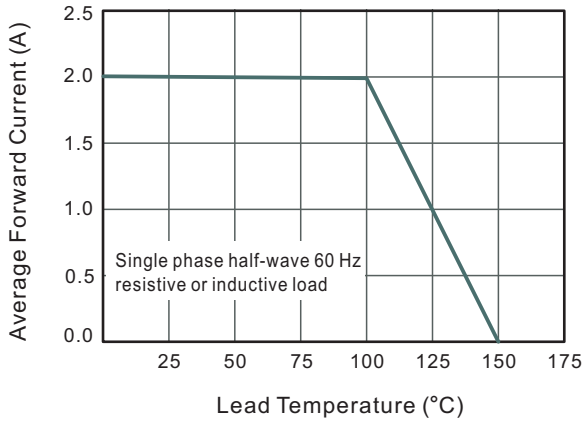

Fig.2 Typical Instantaneous Reverse Characteristics

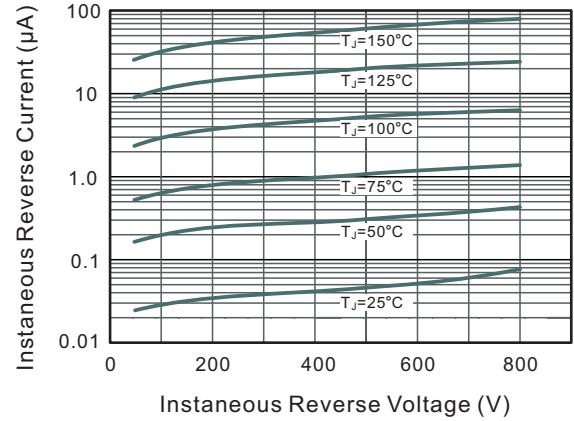

Fig.3 Typical Forward Characteristic

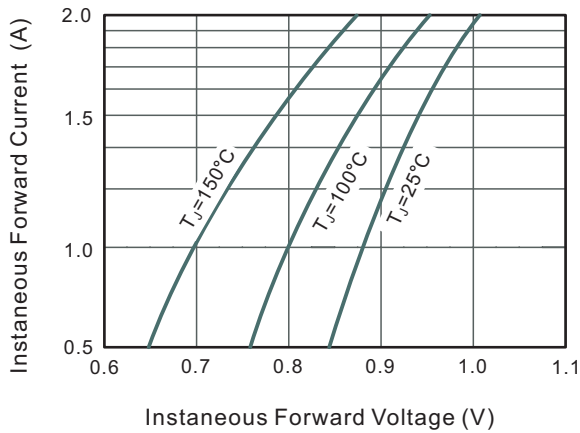

Fig.4 Typical Junction Capacitance

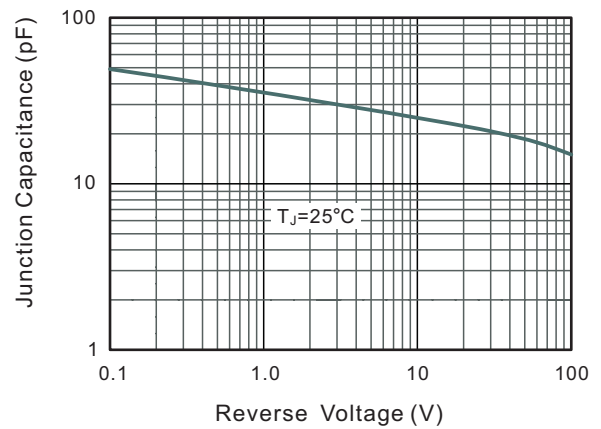
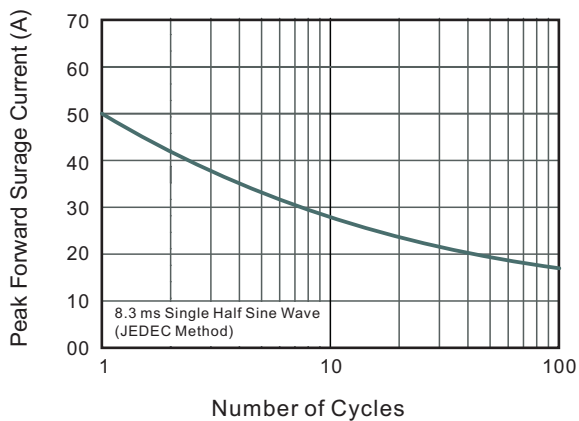

Fig.5 Maximum Non-Repetitive Peak Forward Surge Current





# S2AF THRU S2MF Surface Mount Standard Rectifiers

## PACKAGE OUTLINE

Plastic surface mounted package; 2 leads

SMAF

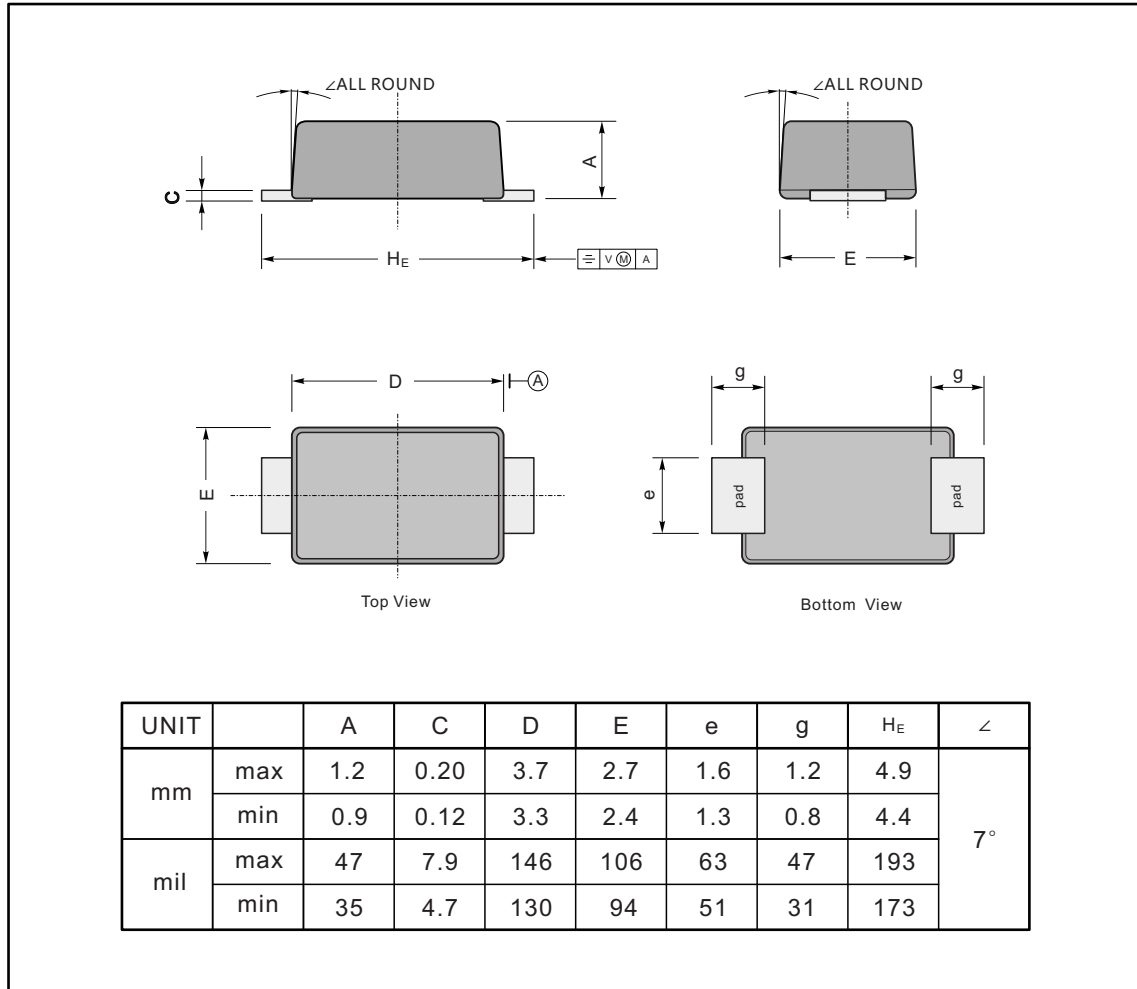

### The recommended mounting pad size

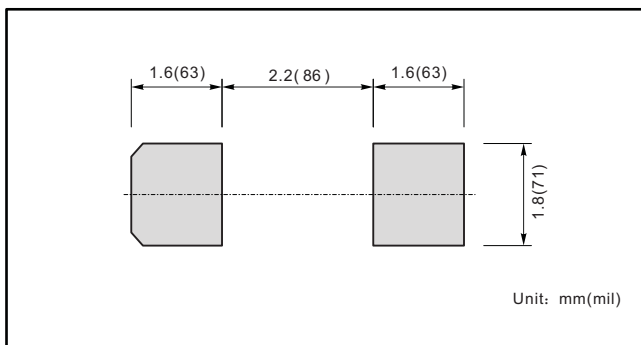

### Marking

Type number	Marking code
S2AF	S2A
S2BF	S2B
S2DF	S2D
S2GF	S2G
S2JF	S2J
S2KF	S2K
S2MF	S2M