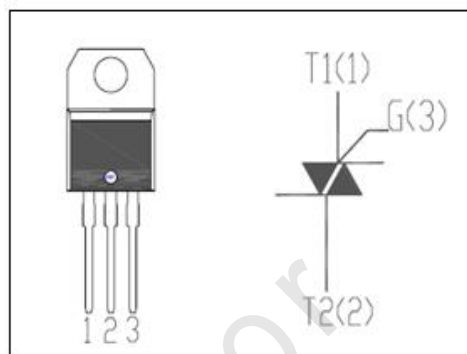

**FEATURES**

- With TO-220AB non insulated package
- Suitable for general purpose AC switching. Which can be used as an ON/OFF function in applications such as static relays, heating regulation, induction motor starting circuits. Or for phase control operation in light dimmers, motor speed controllers etc.

**ABSOLUTE MAXIMUM RATINGS (Ta=25°C)**

SYMBOL	PARAMETER	MIN	UNIT
V <sub>DRM</sub>	Repetitive peak off-state voltage	600	V
V <sub>RRM</sub>	Repetitive peak off-state voltage	600	V
I <sub>T(RMS)</sub>	RMS on-state current (full sine wave)	10	A
I <sub>TSM</sub>	Non-repetitive peak on-state current t <sub>p</sub> =20ms	100	A
T <sub>j</sub>	Operating junction temperature	125	°C
T <sub>stg</sub>	Storage temperature	-40~150	°C
R <sub>th(j-c)</sub>	Thermal resistance, junction to case	2.4	°C/W
R <sub>th(j-a)</sub>	Thermal resistance, junction to ambient	60	°C/W

**ELECTRICAL CHARACTERISTICS (T<sub>c</sub>=25°C unless otherwise specified)**

SYMBOL	PARAMETER	CONDITIONS	B	C	UNIT	
I <sub>RRM</sub>	Repetitive peak reverse current	V <sub>R</sub> =V <sub>RRM</sub> , V <sub>R</sub> =V <sub>RRM</sub> , T <sub>j</sub> =110°C	0.01 0.5	0.01 0.5	mA	
I <sub>DRM</sub>	Repetitive peak off-state current	V <sub>D</sub> =V <sub>DRM</sub> , V <sub>D</sub> =V <sub>DRM</sub> , T <sub>j</sub> =110°C	0.01 0.5	0.01 0.5	mA	
I <sub>GT</sub>	Gate trigger current	V <sub>D</sub> =12V; R <sub>L</sub> = 30 Ω	I	50	25	mA
			II	50	25	
			III	50	25	
			IV	100	50	
I <sub>H</sub>	Holding current	I <sub>GT</sub> = 0.5A, Gate Open	50	25	mA	
V <sub>GT</sub>	Gate trigger voltage all quadrant	V <sub>D</sub> =12V; R <sub>L</sub> = 30 Ω	1.3		V	
V <sub>TM</sub>	On-state voltage	I <sub>T</sub> = 14A; t <sub>p</sub> = 380 μs	1.55		V	

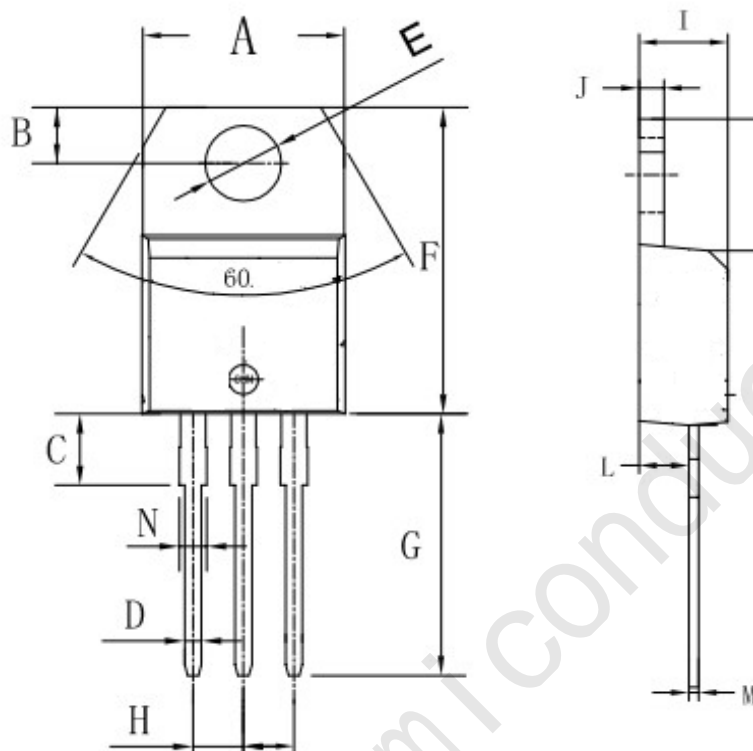
**TO-220AB PACKAGE OUTLINE DIMENSIONS**

Symbol	Dimensions In Millimeters		Dimensions In Inches	
	Min	Max	Min	Max
A	9.8	10.4	0.385	0.409
B	2.65	3.1	0.104	0.122
C	2.8	4.2	0.110	0.165
D	0.7	0.92	0.027	0.036
E	3.75	3.95	0.147	0.155
F	14.8	16.1	0.582	0.633
G	13.05	13.6	0.513	0.535
H	2.4	2.7	0.094	0.106
I	4.38	4.61	0.172	0.181
J	1.15	1.36	0.045	0.053
K	5.85	6.82	0.230	0.268
L	2.35	2.75	0.092	0.108
M	0.35	0.65	0.013	0.025
N	1.18	1.42	0.046	0.055