

THIS DOCUMENT IS SUBJECT TO CHANGE WITHOUT NOTICE. IT IS CONFIDENTIAL AND A PROPERTY OF Amphenol LTW. DISCLOSURE TO THIRD PARTY HAS TO BE AUTHORIZED BY Amphenol LTW.

REV.	ECN NO.	DATE	SIGN	DESCRIPTION
B	LEN1741194~97	2017/04/11	Jinhai	Add The Size Table
C	C200275	2020/03/12	Nan_Su	$\triangle C$ X1
D	C210309	2021/02/24	Ruru	$\triangle D$ X4

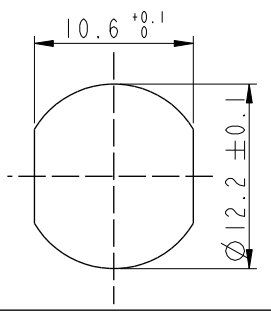

Recommended Panel Cut-Out

$\triangle D$   
M12A-XXPMMR-SF7003  
XX: No. Of Pin

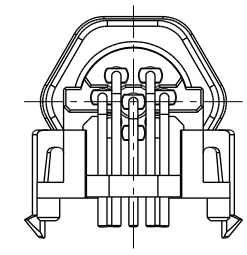
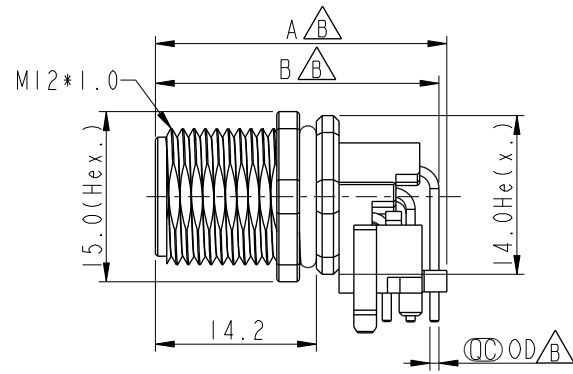
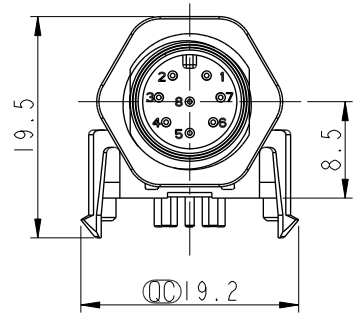
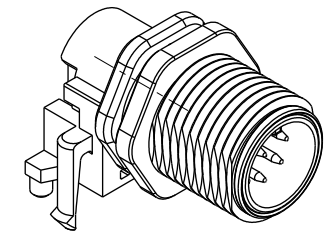
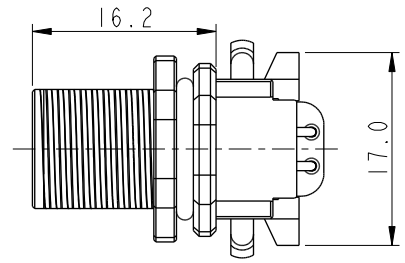

M12A-03PMMR-SF7003	25.9	24.8	1.0	$\triangle B$
M12A-04PMMR-SF7003	25.9	24.8	1.0	
M12A-05PMMR-SF7003	25.9	24.8	1.0	
M12A-08PMMR-SF7003	25.7	25.0	0.8	
Item No.	A	B	OD	

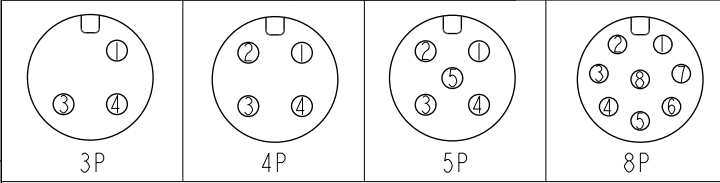

Pin Assignment Front View

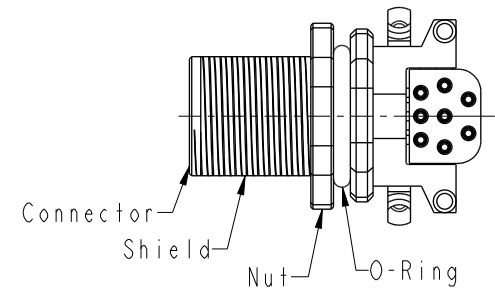

- $\triangle D$  Note:
- \* RoHS Compliant
  - \*  $\odot$  Important dimension
  - \* Waterproof rate: IPX7, mated
  - \* Connector
  - Housing: Thermoplastic, Black
  - Pin: Copper alloy, Gold plated
  - O-Ring: Rubber, Black
  - \* Shield: Metal
  - \* Nut: Metal
  - \* O-Ring: Rubber, Gray
  - \* For panel thickness max: 3.0mm
  - $\triangle C$  \* For pcb thickness max: 1.6mm
  - \* O-Ring and nut are assembled on connectors

UNIT: mm			TITLE N SEN, M12 A, SCREW RECEPTACLE, M, M, PCB R $\triangle D$
TOLERANCE .X ±0.25 .XX ±0.1 .XXX ±0.05 ANGLES ±1°	SCALE 3:2	SIZE A4	SHEET 1 OF 2
REV. D	WC-REV. A.3	$\odot$ : Inspection item	

**Amphenol LTW**  
安費諾亮泰企業股份有限公司

ITEM NO.	DRAWN BY Jinhai	DATE 2017-04-11
DWG NO. M12A-XXPMMR-SF7003	CHECKED BY Feng-li	DATE 2017-04-11
CUSTOMER ALTW	APPROVED BY Jerry	DATE 2017-04-11

THIS DOCUMENT IS SUBJECT TO CHANGE WITHOUT NOTICE. IT IS CONFIDENTIAL AND A PROPERTY OF Amphenol LTW. DISCLOSURE TO THIRD PARTY HAS TO BE AUTHORIZED BY Amphenol LTW.

PCB Layout

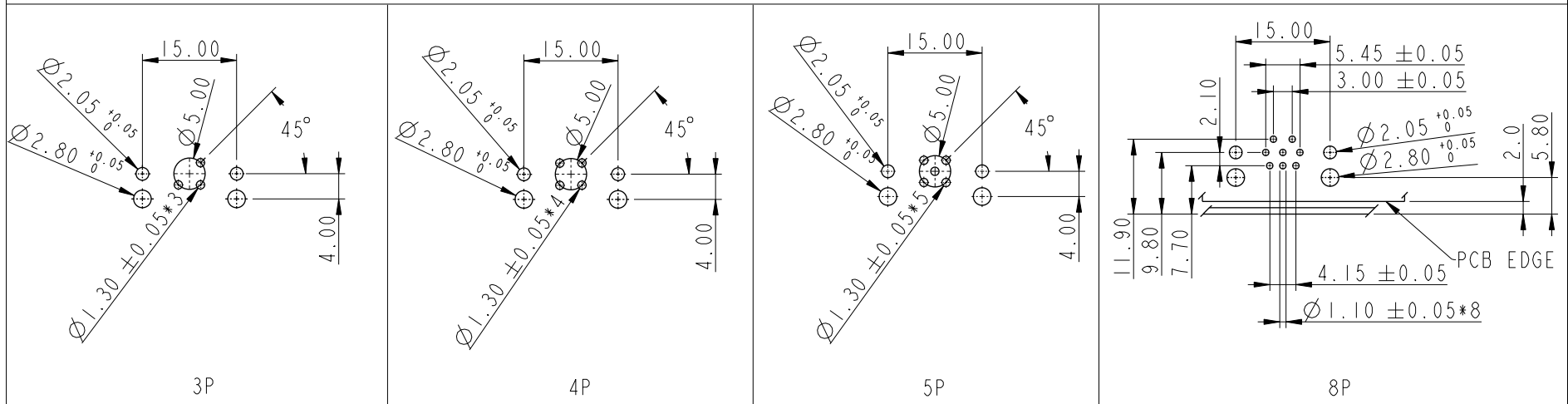

3P

4P

5P

8P

UNIT: mm

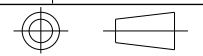

TITLE  
N SEN, M12 A, SCREW  
RECEPTACLE, M, M, PCB R

**Amphenol LTW**

ITEM NO

DRAWN BY  
Yulong\_wang

DATE  
2017-04-11

TOLERANCE  
.X ±0.25  
.XX ±0.1  
.XXX ±0.05  
ANGLES ±1°

SCALE 3:2 SIZE A4 SHEET 2 OF 2

安費諾亮泰企業股份有限公司

DWG NO  
M12A-XXPMMR-SF7003

CHECKED BY  
Jinhai

DATE  
2017-04-11

REV. D WC-REV. A.3 : Inspection item

CUSTOMER  
ALTW

APPROVED BY  
Jerry

DATE  
2017-04-11