

THIS DOCUMENT IS SUBJECT TO CHANGE WITHOUT NOTICE. IT IS CONFIDENTIAL AND A PROPERTY OF Amphenol LTW. DISCLOSURE TO THIRD PARTY HAS TO BE AUTHORIZED BY Amphenol LTW.

| | | | | |
|------|---------|------|------|-------------|
| REV. | ECN NO. | DATE | SIGN | DESCRIPTION |
| | | | | |
| | | | | |
| | | | | |

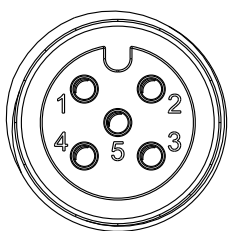

Conn. 1&2&3
Pin Assignments
Front View

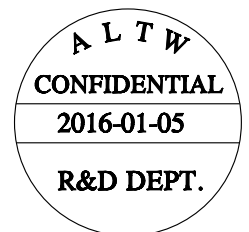
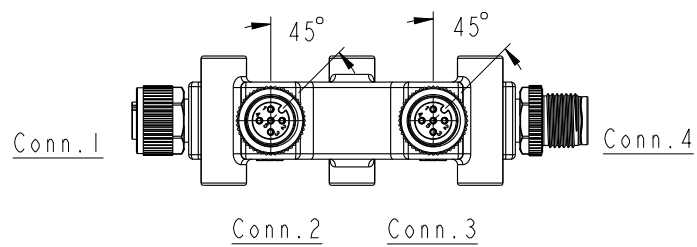
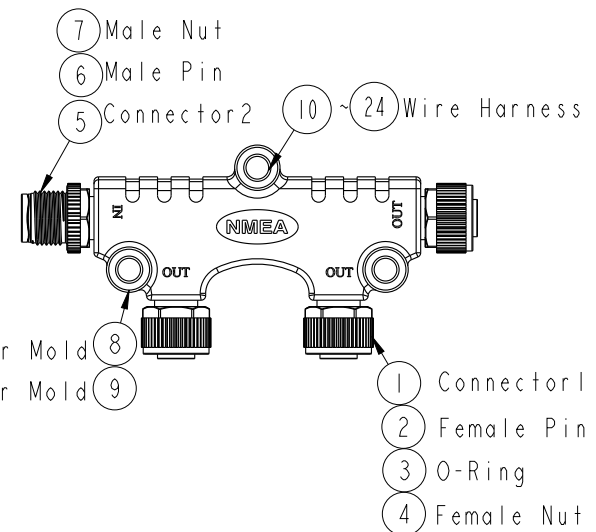
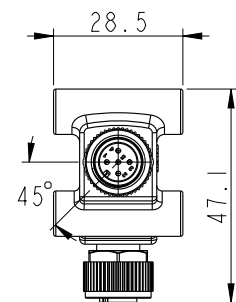
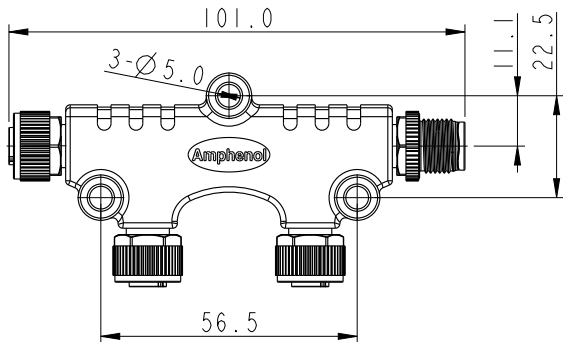
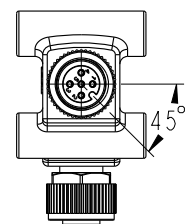
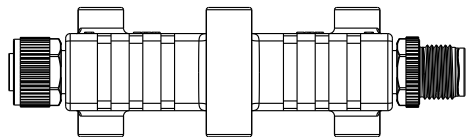
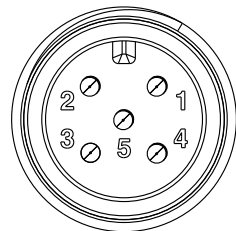

Conn. 4
Pin Assignments
Front View

| | | | | |
|------------|---------|--------|--------|--------|
| Blue 藍 | 5 | 5 | 5 | 5 |
| White 白 | 4 | 4 | 4 | 4 |
| Black 黑 | 3 | 3 | 3 | 3 |
| Red 紅 | 2 | 2 | 2 | 2 |
| Green 綠 | 1 | 1 | 1 | 1 |
| Wire Color | Conn.1 | Conn.2 | Conn.3 | Conn.4 |
| | Pin Out | | | |

Note:
 * \varnothing Important Dimension To Check.
 * Waterproof Rate: IP68
 In 1 meter water within 24 hours
 * Connector: Pu, Black
 * Nut: PA66, Black
 * Pin: Copper Alloy, Gold Plated 30u"
 * Outer Mold: PU, Blue
 * Wire Harness: UL1061, 22AWG

UNIT: mm
 TOLERANCE ±0.50mm

TITLE NMEA2000 Micro-C
2-WAY TEE
 SCALE 1:1 SIZE A4 SHEET 1 OF 1
 REV. A WC-REV. A.1 \varnothing : Inspection item

Amphenol LTW
 安費諾亮泰企業股份有限公司

| | | |
|----------------------------------|----------------------|--------------------|
| ITEM NO. P-555500-FFFM00-S001 | DRAWN BY Cary | DATE 2016-01-05 |
| DWG NO. P-555500-FFFM00-S001 | CHECKED BY Yulong | DATE 2016-01-05 |
| CUSTOMER ALTW | APPROVED BY Jerry | DATE 2016-01-05 |